

WINGNUT WINGS



DH.9a 'NINAK' (Post War)

1/32 Scale

The AMC DH.9a (Aircraft Manufacturing Company de Havilland 9a) bomber arrived late in the Great War and was born out of the necessity to find a replacement for the under performing DH.9. Intended as a replacement for the 275-350hp Rolls Royce Eagle powered DH.4, with the pilot and gunner repositioned closer together for improved communications, the DH.9 was in fact a great leap backwards due in no small part to the inferior performance and unreliability of its 230hp Puma engine.

Due to the workload at AMC the initial design work for the improved DH.9a was undertaken by Westland Aircraft Works who modified AMC built DH.9 C6350 to accept a 350hp Rolls Royce Eagle VIII engine in anticipation of the imminent arrival of the plentiful 400hp Liberty V12 engine from America. With its larger wings and re-designed nose, C6350 started flight testing in February 1918. The 2nd prototype, and the 1st to be fitted with a Liberty engine, was AMC built C6122 which took to the air on 19 April 1918. In July 1918 it appeared that the supply of Liberty engines could dry up so a 3rd prototype, Westland built B7644, was produced to accept the 350hp Eagle VIII, but as it turned out the supply of Liberty engines proved to be enough for RAF needs.

Remarkably, an initial production order for 400 DH.9a was placed with the Whitehead Aircraft Co in January 1918, a month before the 1st prototype flew. The DH.9a was manufactured by Whitehead, AMC, Mann Eggerton & Co and The Vulcan Motor & Engineering Co as well as numerous rebuilds and small post war production orders from the likes of the de Havilland Aircraft Co, Handley Page Ltd, HG.Hawker Engineering Co Ltd and Short Bros amongst others. An American order for 4000 USD-9A was placed with the Curtis Aeroplane and Motor Company but was canceled due to the Armistice and it appears that only 13 USD-9A were built, all prototypes. At least 2700 unlicensed copies were built in the newly formed Soviet Union as the Polikarpov R-1. Post war developments (as provided in this model) included improved undercarriage, an auxiliary radiator, additional gravity petrol tank and leading edge wing slats. Further developments included a raised 'hump back' fuselage and oleo suspension undercarriage.

The DH.9a 'Ninak' (Nin = 9, ack = A) entered front line service with the RAF and USMC in late 1918 and went on to lengthy post war service with the RAF in Germany, Russia and the Middle East and saw service in Canada, Australia and in the Soviet Union and China (as the Polikarpov R-1).

Early aircraft colours are contentious at the best of times and we have done our best to provide what we consider to be accurate painting information. Towards the end of 1918 the RAF replaced PC10 with AMAPD (AMA Protective Dope) which contained pigments giving a 'dark chocolate brown appearance' and AMAPDT (AMA Protective Dope Tropical) dark reddish brown for aircraft destined for service in the tropics. In the 1920s most aircraft were silver doped overall with their aluminium engine cowlings frequently unpainted. Steel components, fittings and brackets were usually painted black unless overpainted with silver. The Polikarpov R-1 appears to have initially been finished overall in a pale finish (white or silver?) and later with a dark olive green 'zashchitnyi' (protective) finish on the upper surfaces and light blue-grey undersides. Almost all Polikarpov R-1 featured extensive political slogans.

Richard Alexander 2015









Wingspan:	Length:	Max Weight:	Max Speed:
45' 11" (14m)	30' 3" (9.22m)	4815lb (2184kg)	120mph (193kph)
No. manufactured:	Production:	Engine:	Ceiling:
Approximately 2000	February 1918 to 1928	400hp Liberty V12	18,000' (5486m)
Armament:			
.303 (7.7mm) Vickers gun and 1 or 2 .303 (7.7mm) Lewis gun on Scarff ring. Up to 660lb (300kg) of bombs.			
References:			
Handbook on the DH.9a Aeroplane, Air Ministry, 1924 - Schedule for DH.9a - Windsock International v20 #3 2004, Windsock International v20 #4 2004 - Windsock Datafile 139 & 141, AMC DH.9a 'Ninak' volume 1 & 2, John Alcorn 2010 - The DH.4/DH.9 File, Ray Sturtivant & Gordon Page, Air Britain 1999 - de Havilland DH.9a (RAF 1918-30), Profile Publications, Chaz Bower 1973 - FliegerRevue Extra #24, 2009 The Vintage Aviator Ltd - RAF Museum Hendon - 1914-18 Aviation Heritage Trust - Colin Owers - Private Collections			

DH.9a 'NINAK' (Post War)

1/32 Scale

- Warning:** Choking hazard. Keep small parts and plastic bags away from children. Use glue and paint in a well ventilated area. Always wear protective eyewear when cutting and a protective mask when painting, gluing and sanding. Do not breathe dust from polyurethane resin parts (if included). Beware of sharp edges on metal parts.
- Assembly:** **Read all the instructions carefully before starting assembly.** Use glue intended for plastic models. Assemble metal and resin parts (if included) using Cyanoacrylate (CA) or epoxy glue. Before assembly select a marking option and note optional parts required in instructions.
- Rigging:** If installing rigging please drill out all location holes with a 0.5mm drill bit to a depth of at least 1mm.
- Painting:** Only use paints **designed and suitable** for plastic model kitsets.
- Decals:** Cut out each decal as required. Soak in warm water for 15 seconds. Slide off backing paper onto **gloss painted surface of model (not just clear coated plastic)**. For large decals it is helpful to apply a drop of water to the area they are being applied to. This will make it easier to maneuver them into the correct position.

Hints & Tips: Please visit our website for additional photos, hints and tips to assist you in getting the best result from your Wingnut Wings model.

1 Construction Step	 Choose	 Attention	 Remove
A1 Part Number	 Do Not Cement	 Option	 Drill
5 Decal	 Cement For Metal	 Other Side	 Paint Colour
P1 Photo Etch Part			

	All colours	Tamiya	Humbrol	Federal Standard
a	Brass	X31	54	
b	Copper	XF6	12	
c	Gun Metal	X10	27004	
d	Aluminium	XF16	27001	
e	Steel	XF56	27003	
f	Mustard Yellow - matt	XF60	74	33481
g	Rust	XF9	113	30045
h	Leather - semi gloss	XF52	62	30219
i	Clear Doped Linen (CDL) - semi gloss	XF55	121	26405
j	Battleship Grey - semi gloss	XF82	106	35164
k	Grey-Blue - semi gloss	XF12	65	36314
l	Aluminium Dope - gloss	XF16(x2) + XF19(x1)	11(x1) + 34(x1)	
m	Red Oxide Primer bled through linen - matt	XF9(x1) + XF55(x2)	160(x1) + 121(x2)	
n	Zashchitnyi Olive Green - semi gloss	XF67	102	34095
o	Dark Wood* - semi gloss	XF68*	98*	30111*
p	Black - semi gloss	X18	85	
q	Rubber - matt	XF69	66	35042
r	Light Wood* - semi gloss	XF78*	93*	30340*
s	Red - matt	XF7	60	11350

Note: Apply clear varnish to achieve the desired gloss or semi-gloss finish. *See our website hints and tips for painting wood.

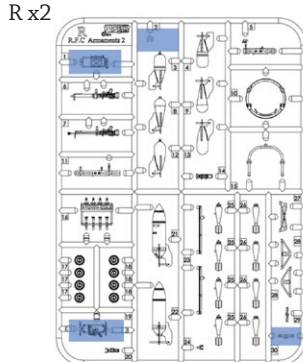
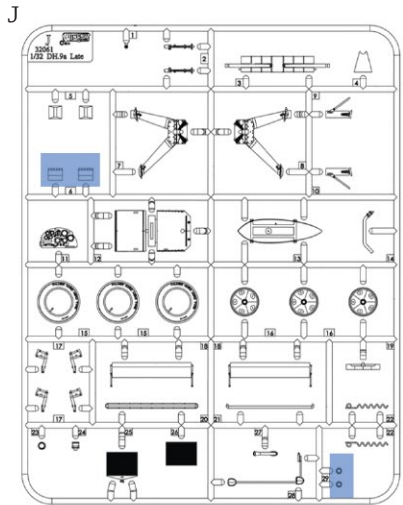
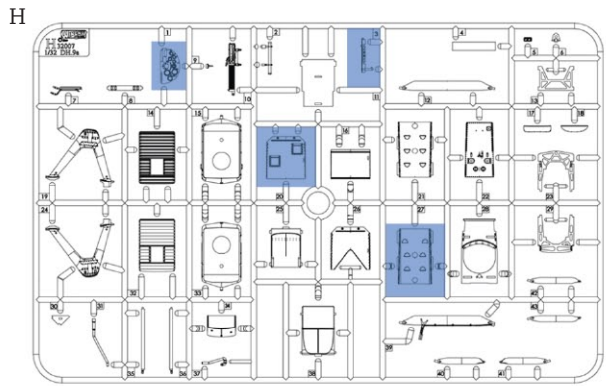
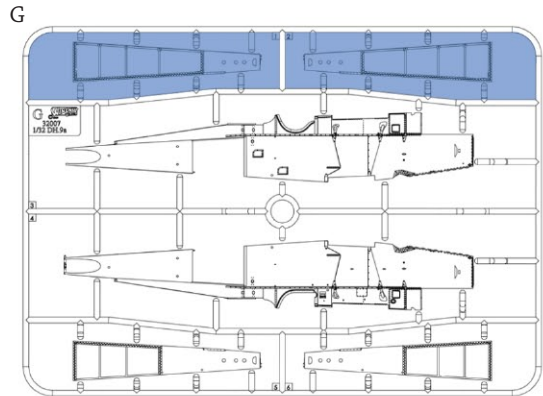
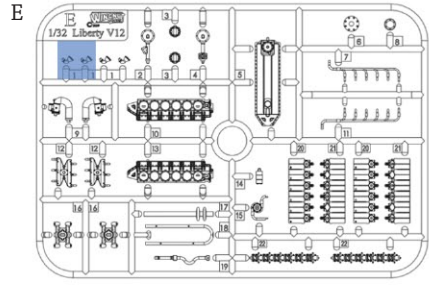
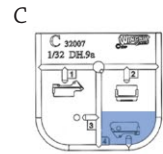
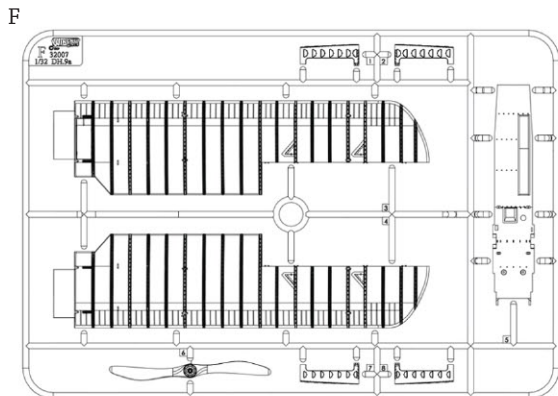
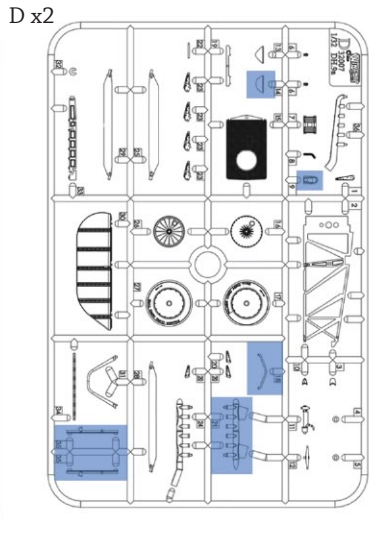
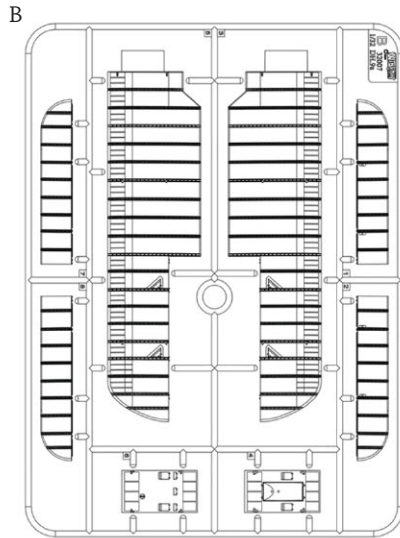
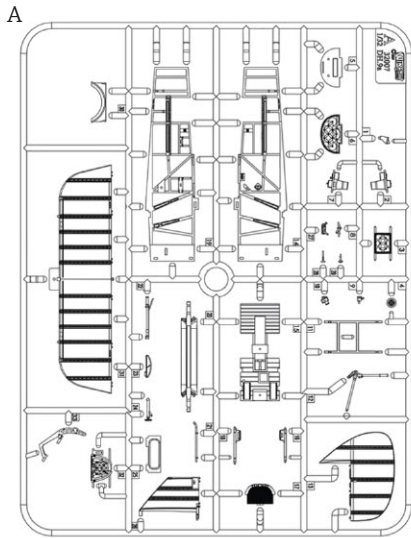

■ = Not Used

Photo Etch

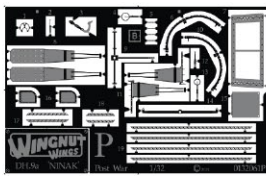

Decals



1 COCKPIT

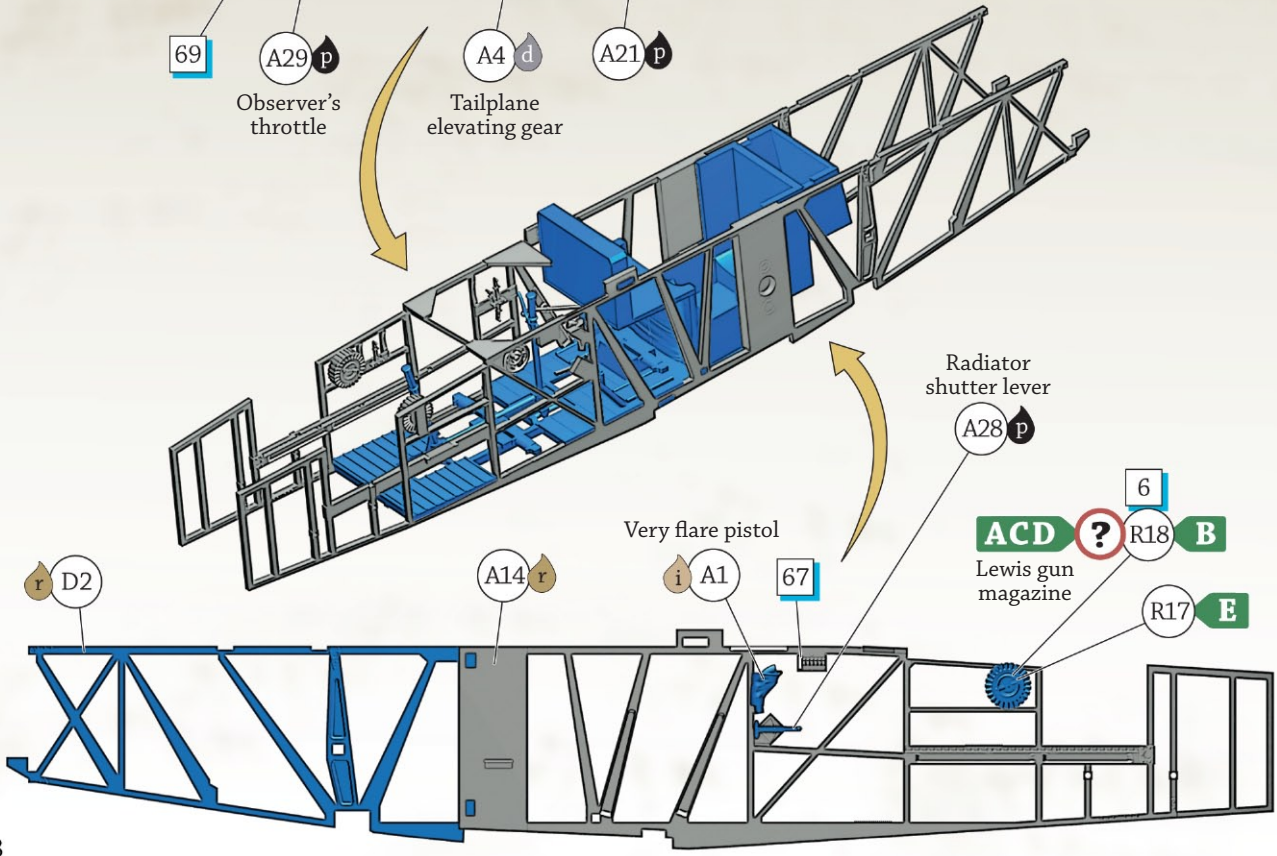
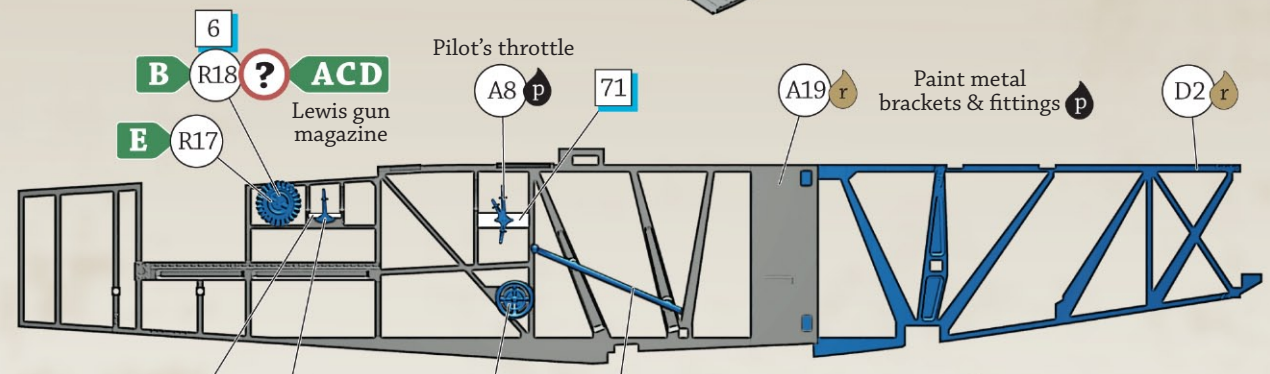
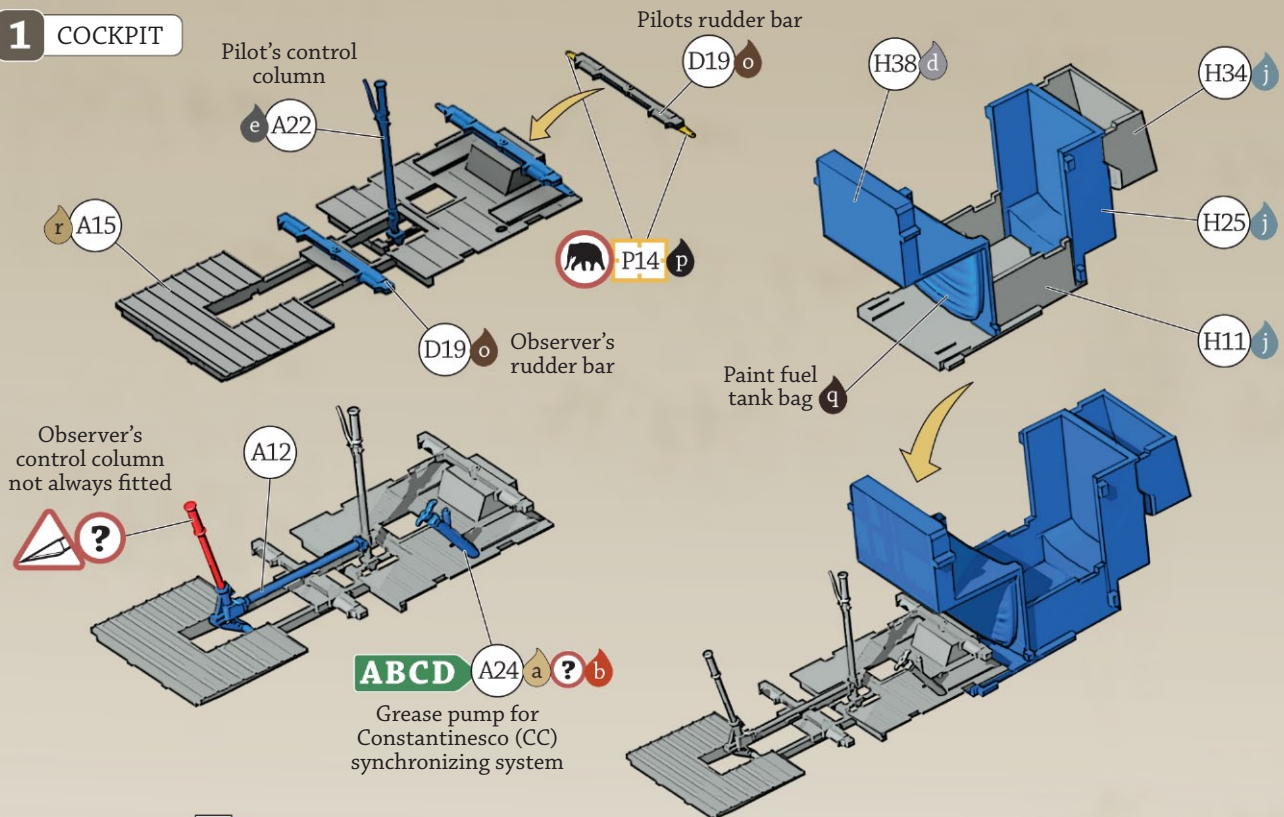

2 COCKPIT continued

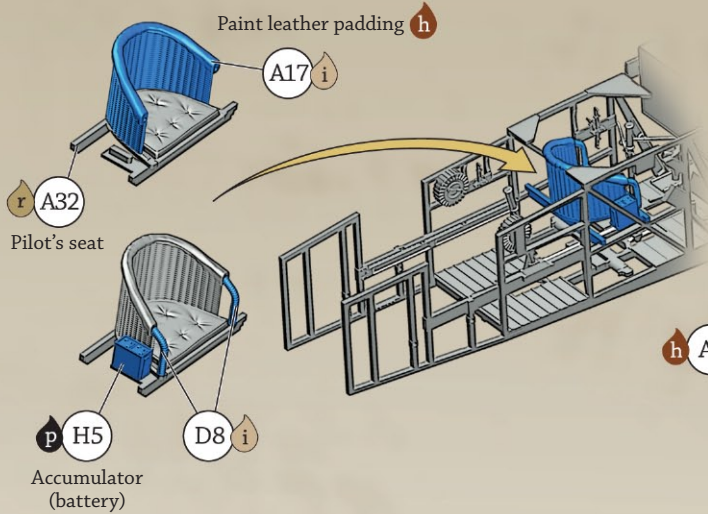

ABCD **J1** **a** Engine ignition switch

E **H6** **p+r**

Remove

ABCD **74**

h **A3**



Instrument board lamp and electrical wire.

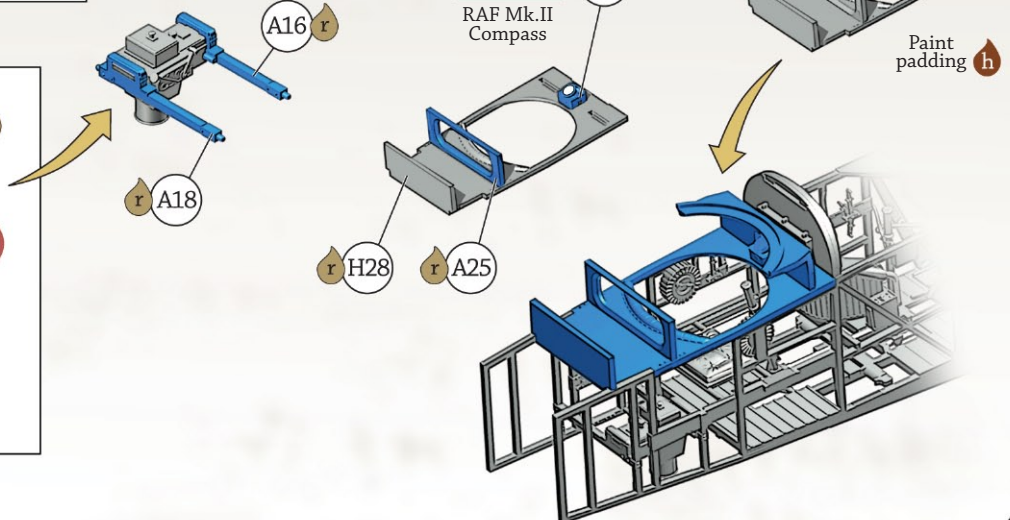
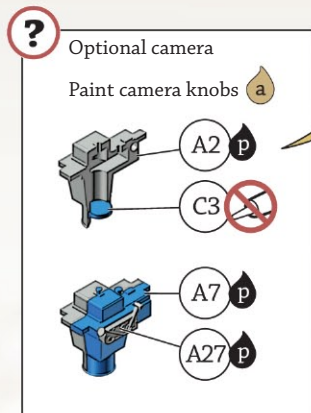
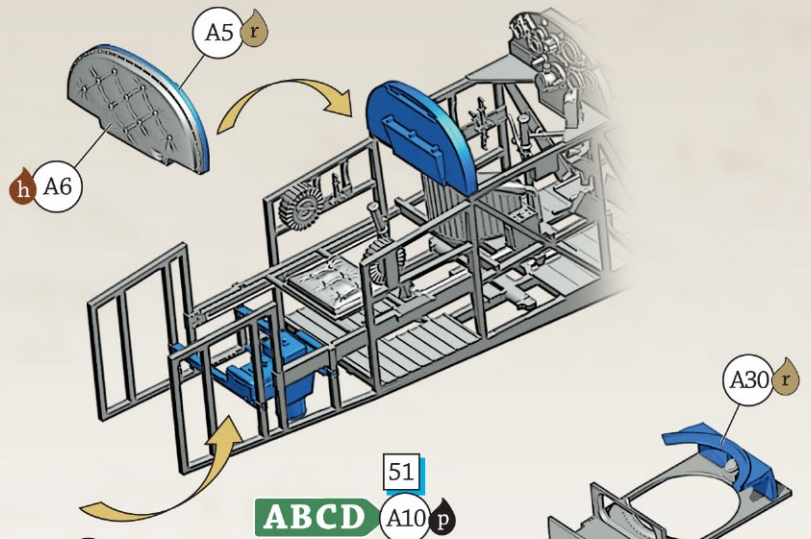
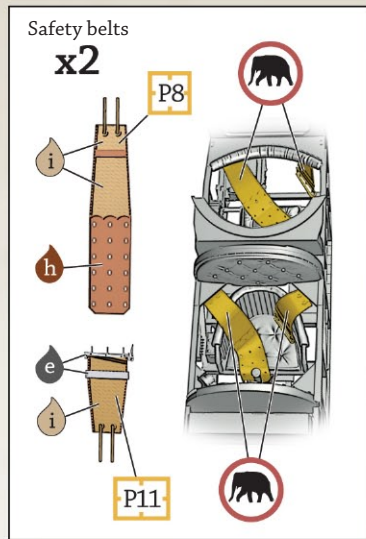
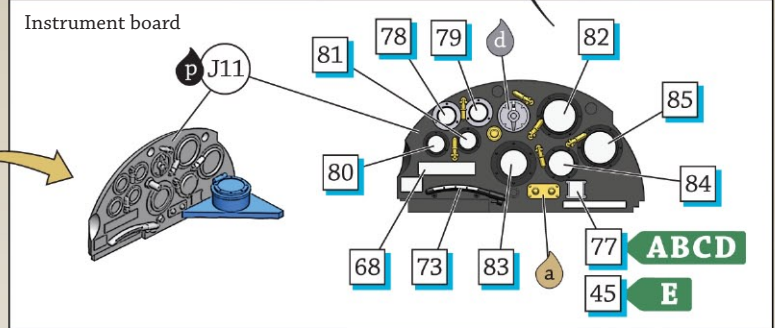
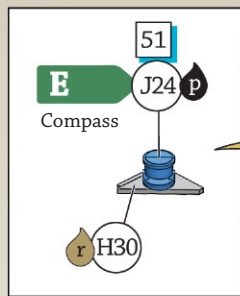
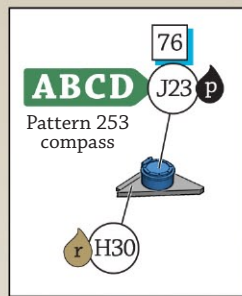



Instrument board detail from F1010 after full restoration to WW1 specifications. Note that post war instrument panels were noticeably different.



Pilot's seat, throttle (A8) and tailplane elevating gear (A4) details.



Control column (A22) with firing handle for the Vickers. Note the bomb sighting hole in the floor.

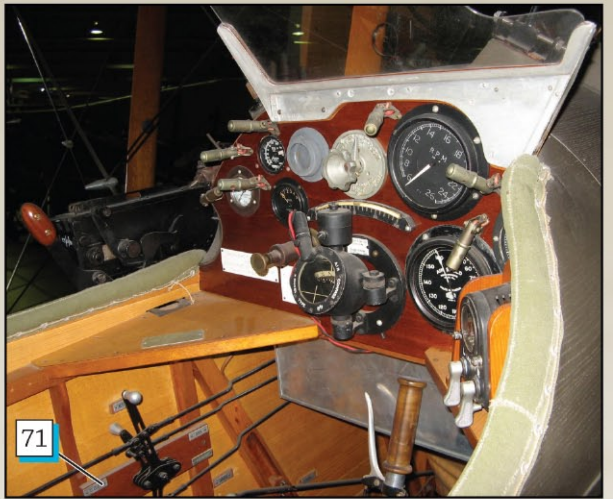

Note the aluminium magazine for Vickers ammunition.



Observer's throttle (A29), seat and Lewis gun ammunition drums (R21). Note the interior colour of the linen fuselage covering.

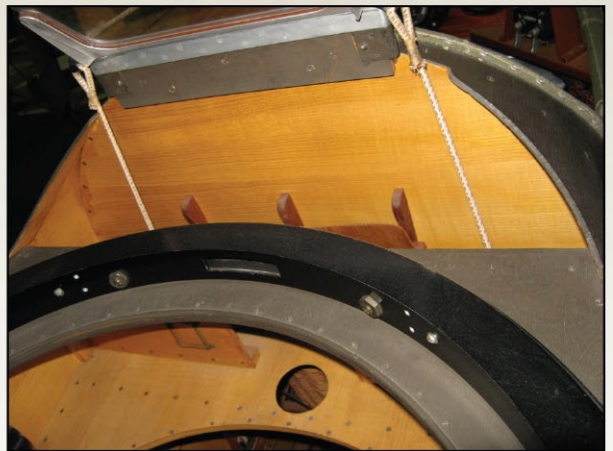

Observer's windshield storage detail and empty hole for his RAF Mk.II compass.



Accumulator (battery), grease pump for the Constantinesco (CC) Vicker gun synchronizing system and empty bracket for the Very flare pistol. The switch board controlled the instrument board lights.

PAINING GUIDE

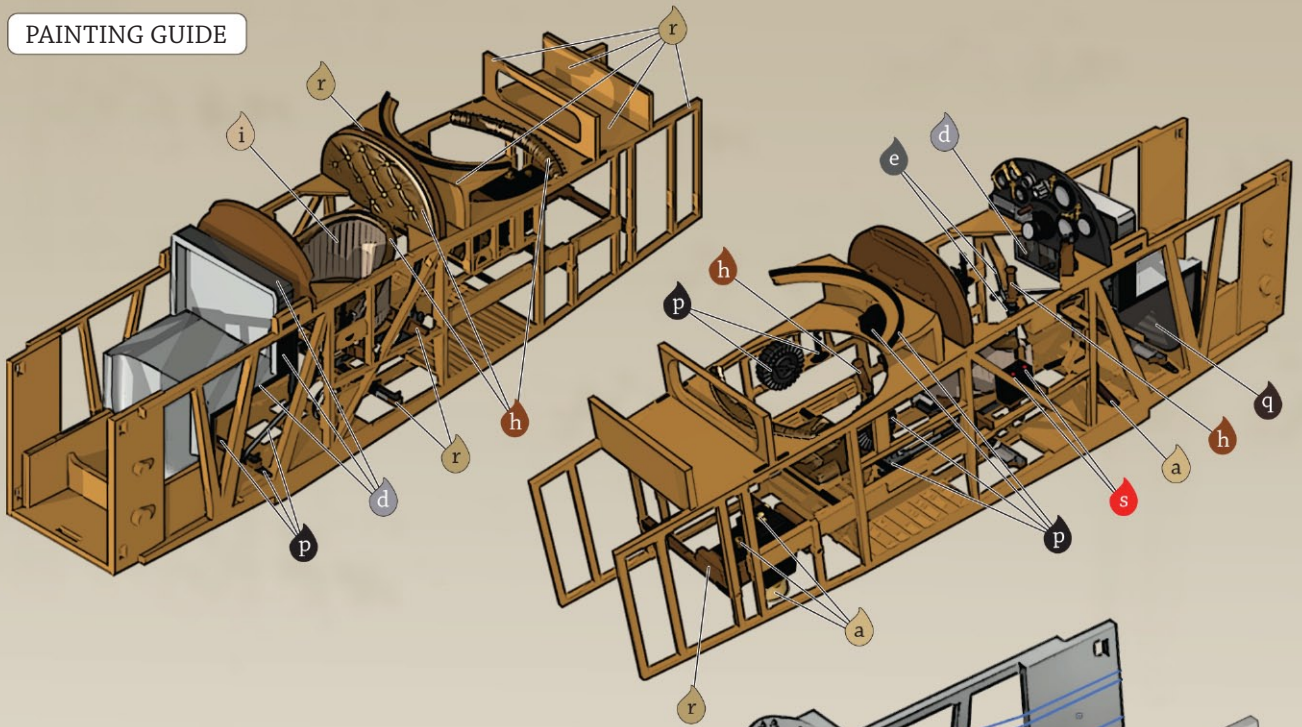

RIGGING GUIDE

0.15mm 
 Rigging material not supplied

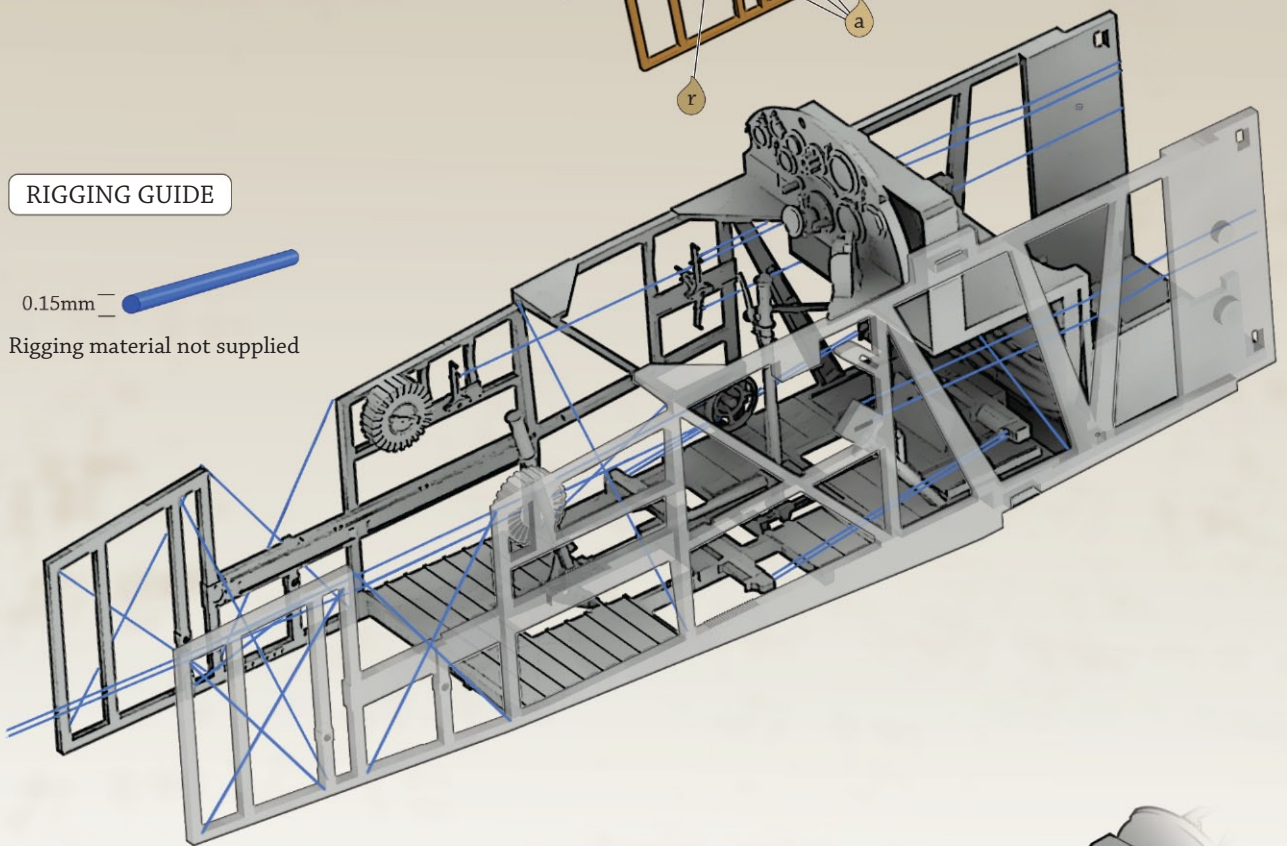

3 ENGINE BAY

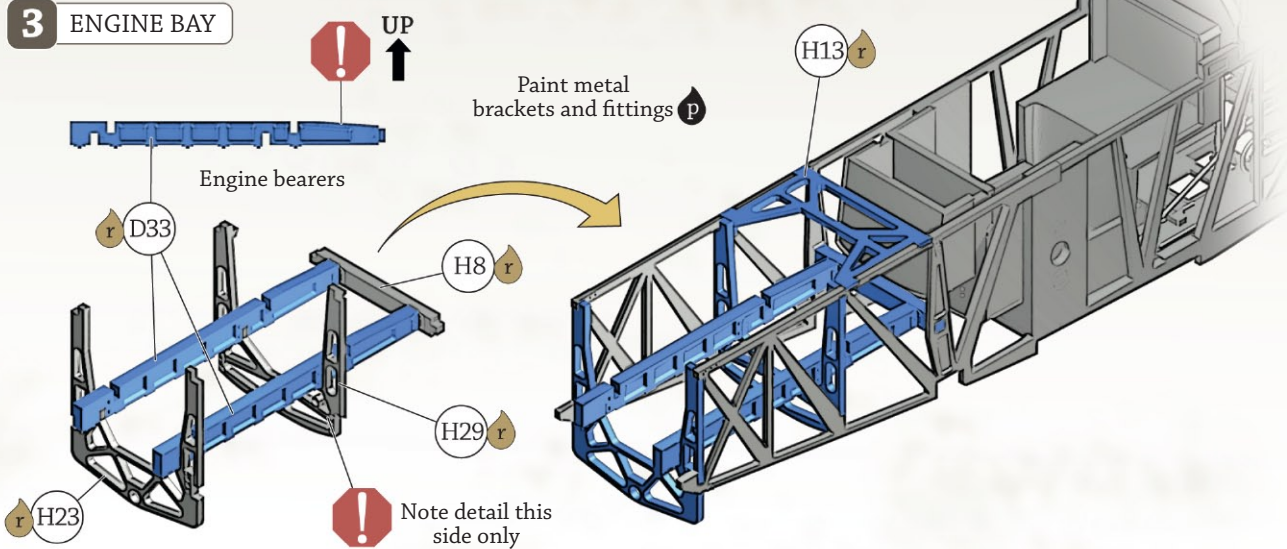

4 LIBERTY V12 400hp ENGINE

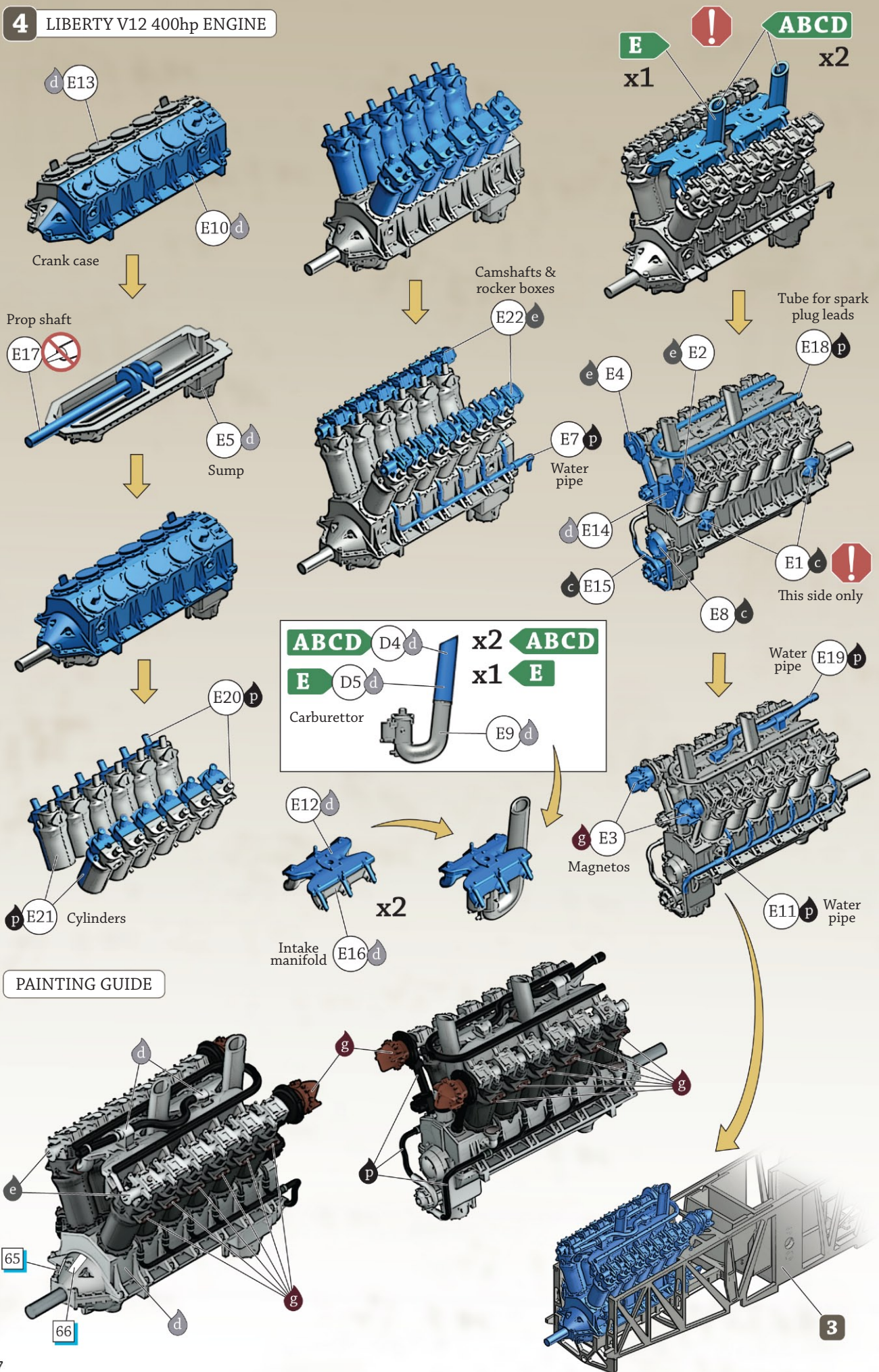

5 FUSELAGE

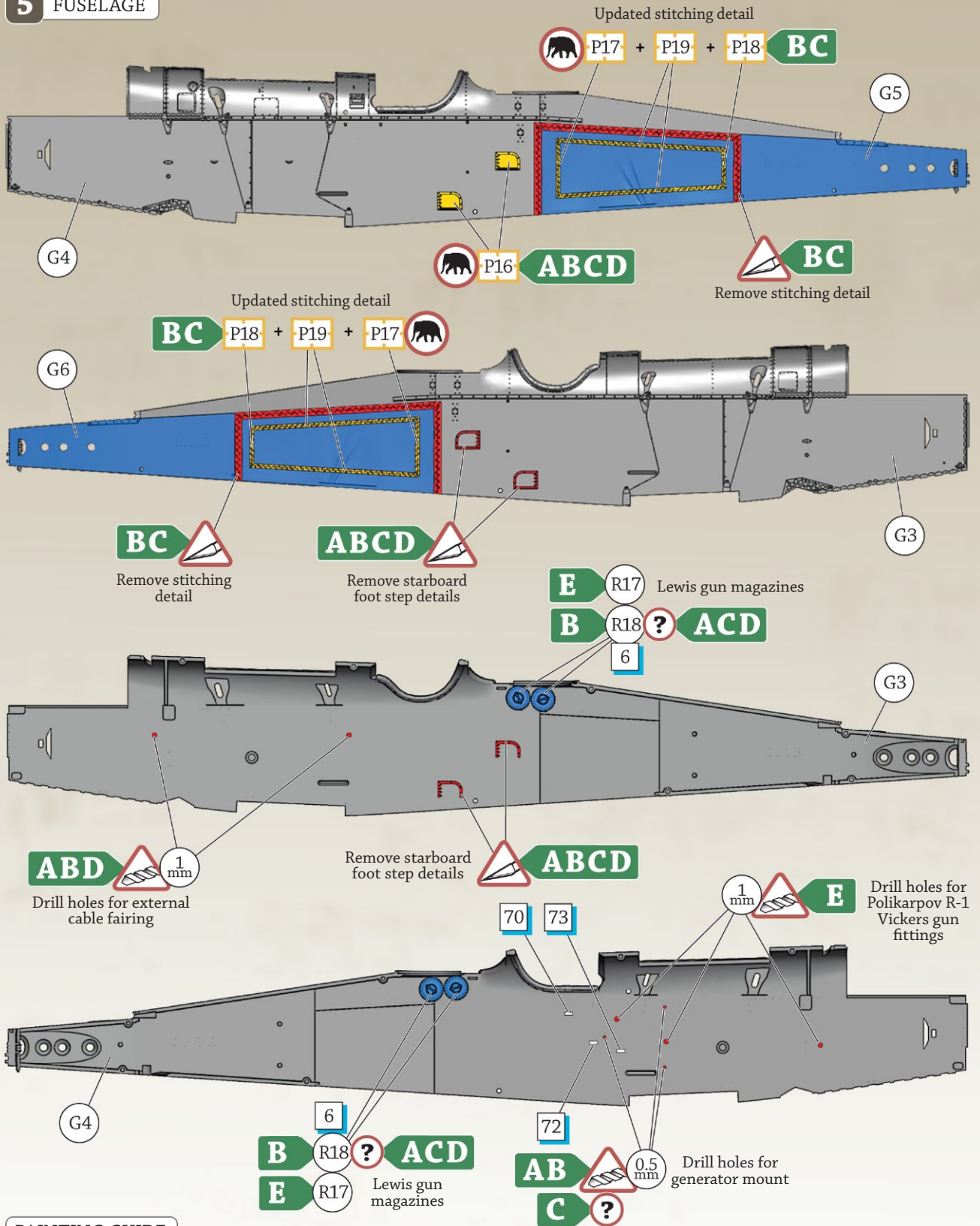

PAINTING GUIDE

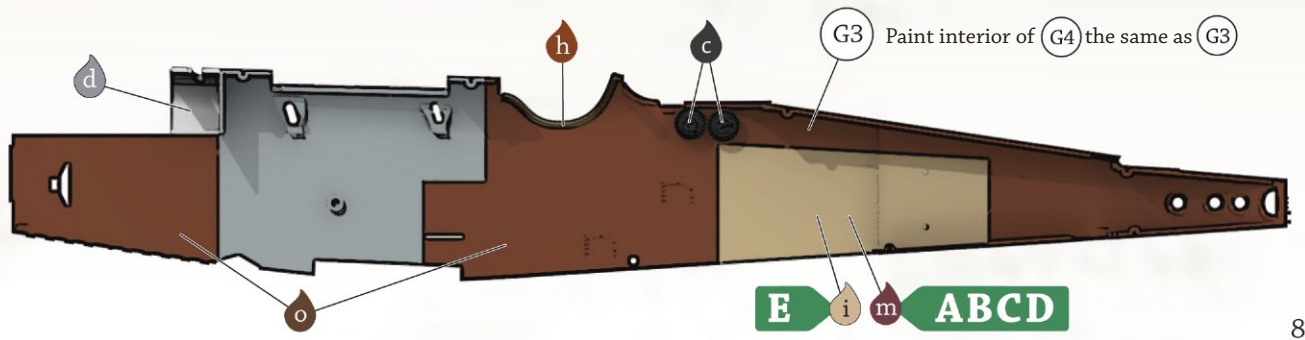

6 FUSELAGE continued

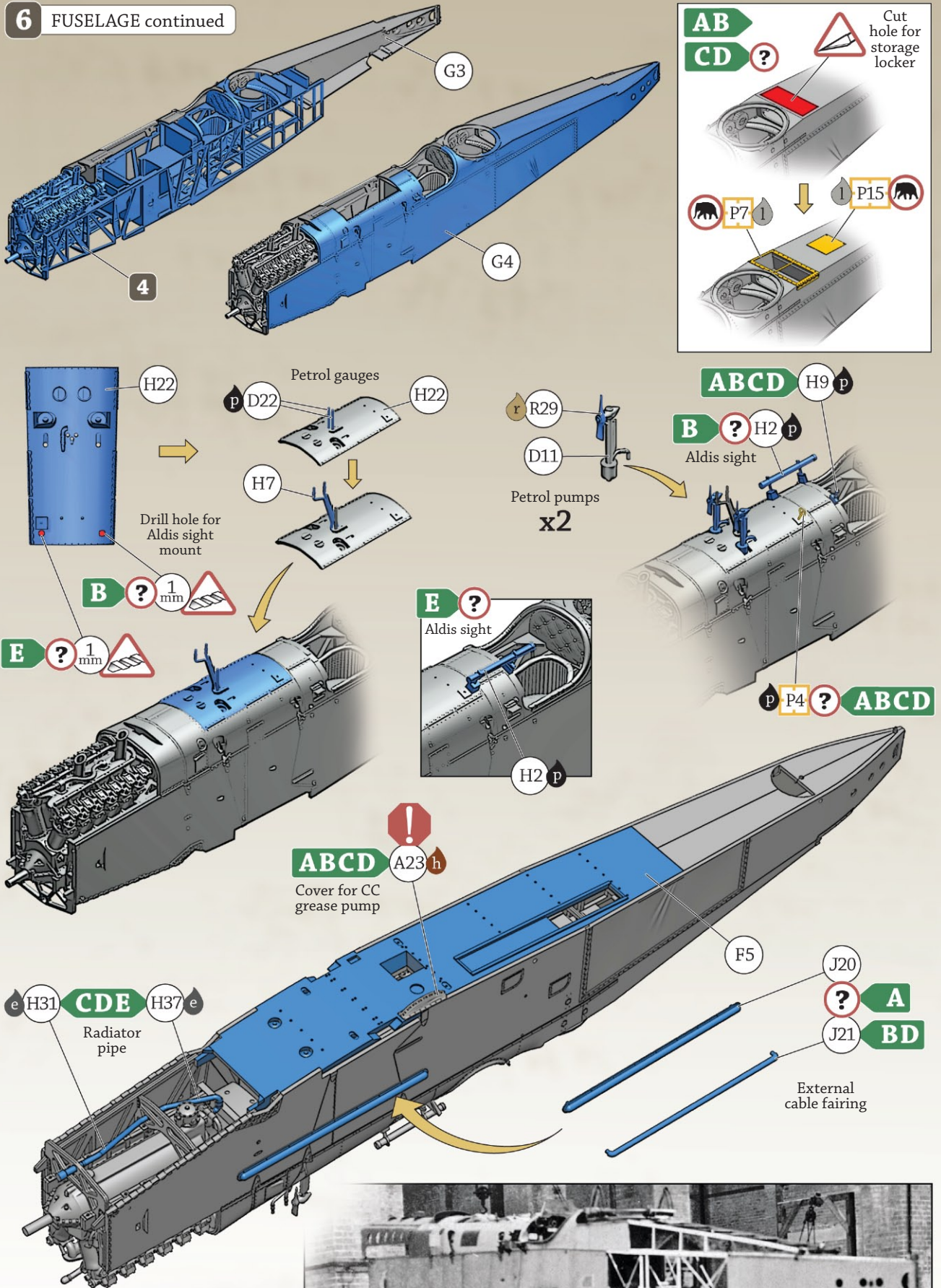

> Late model DH.9a fuselage under construction at AMC clearly showing the extended ply area near the tail and if you look closely in the bottom left corner you can see the cowlings top cover for the petrol tank. Hopefully someone will be inspired to model this scene with their model and we look forward to seeing it.

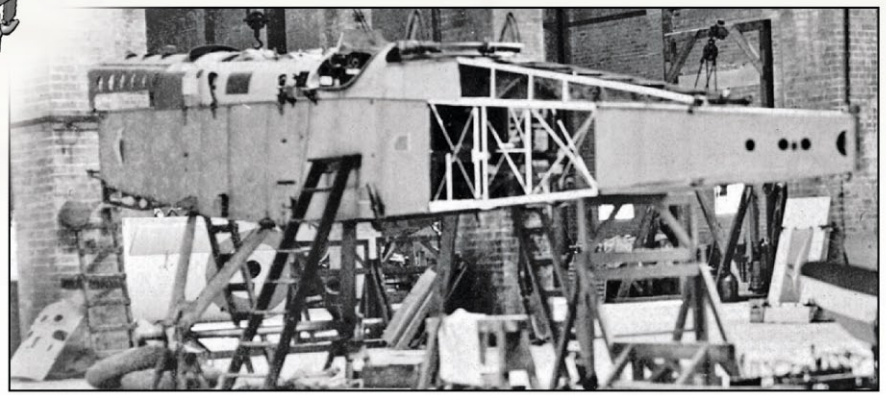

7 RADIATOR & ENGINE COWLINGS

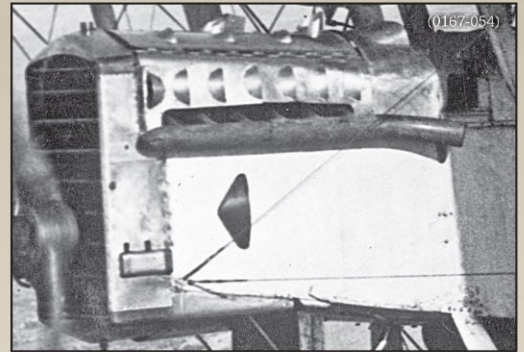
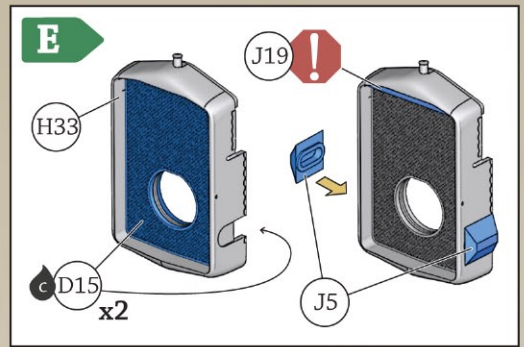
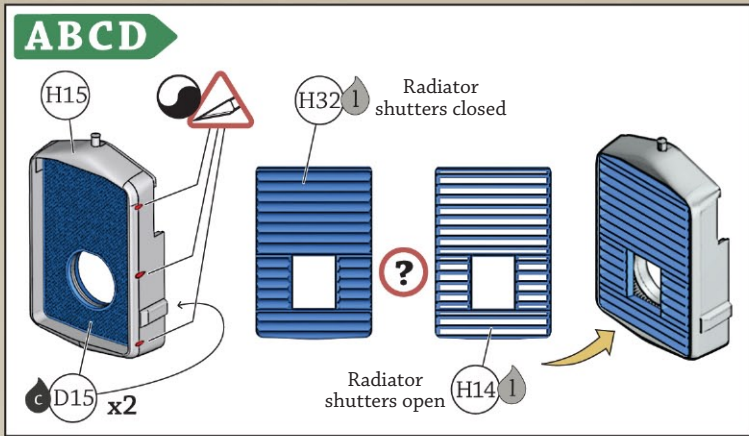

Engine cowl and exhaust detail from Westland built DH.9a H3510 **B**. Note the unpainted aluminium radiator and cowlings and the dark painted corners of the radiator.

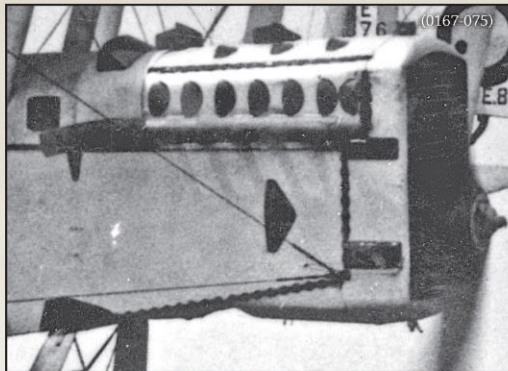
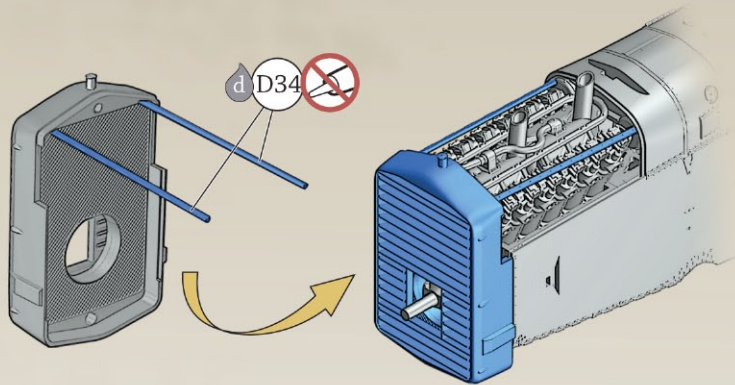

Engine cowl and exhaust detail from Vulcan built DH.9a H3552 **C**. Note the dark painted brackets, hinges, vents and fairings.

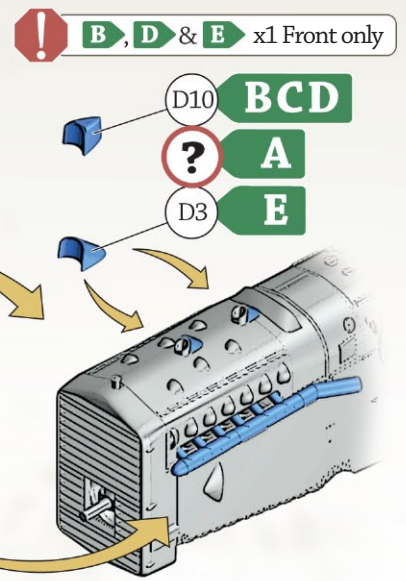
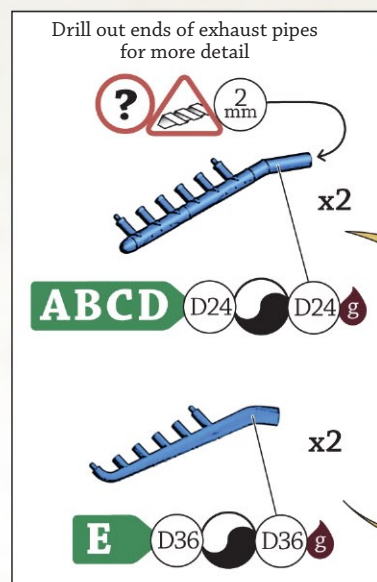
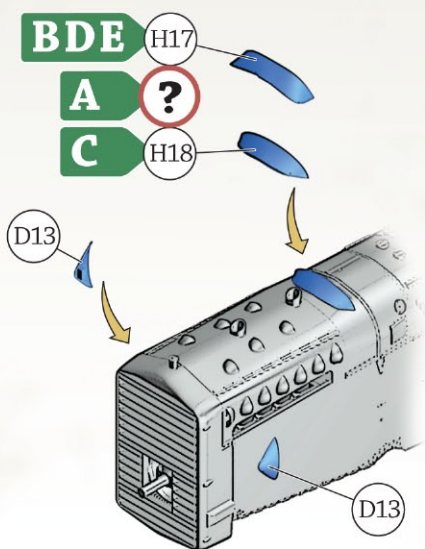
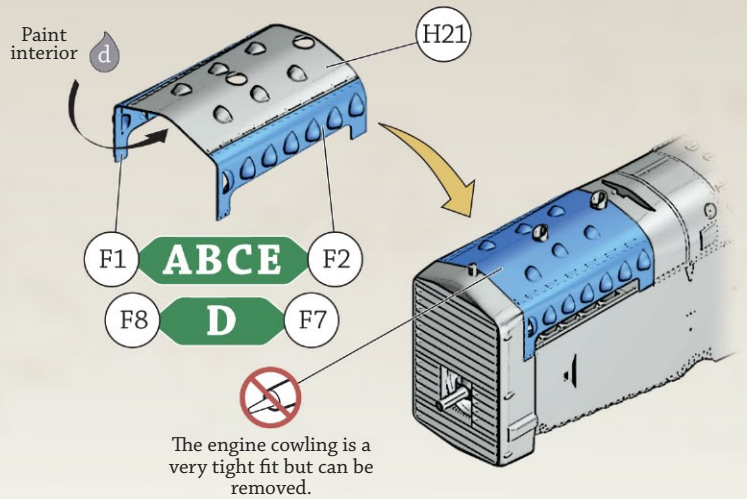

8 TAILPLANE

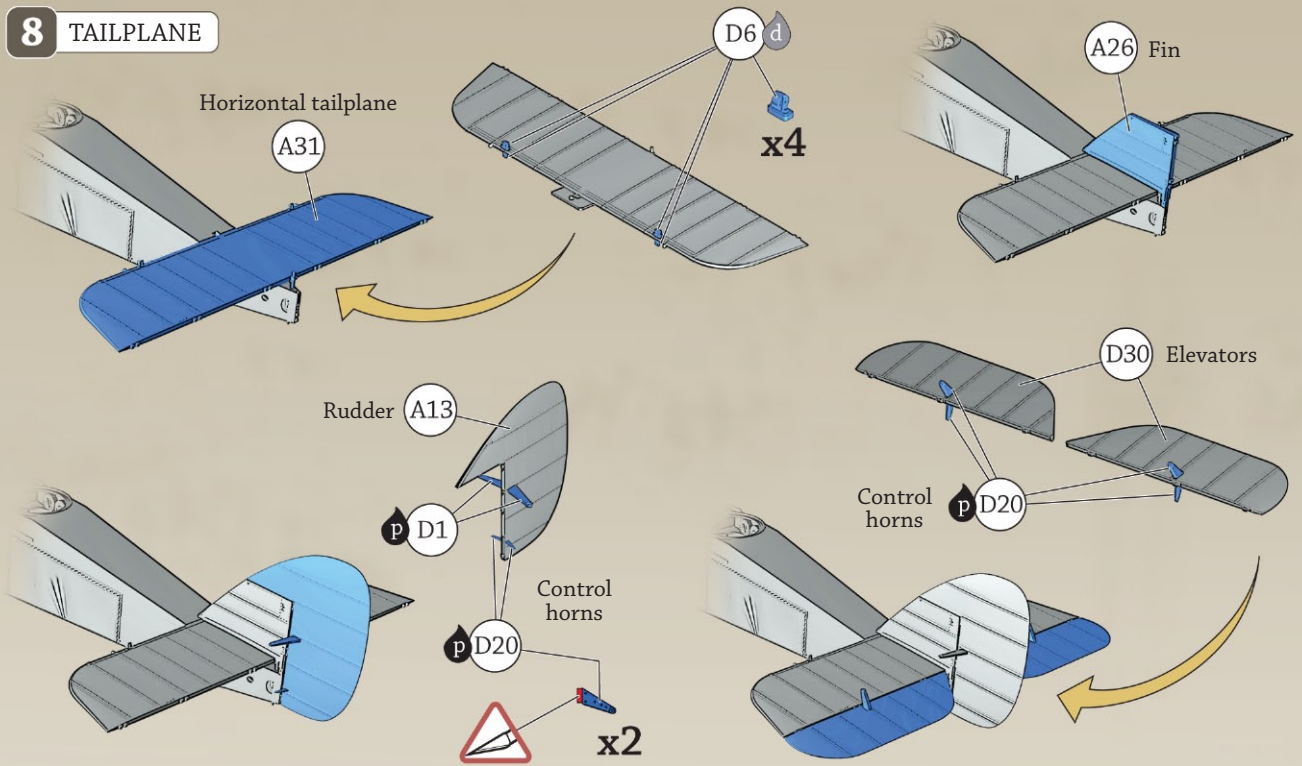

9 BOTTOM WINGS & STRUTS

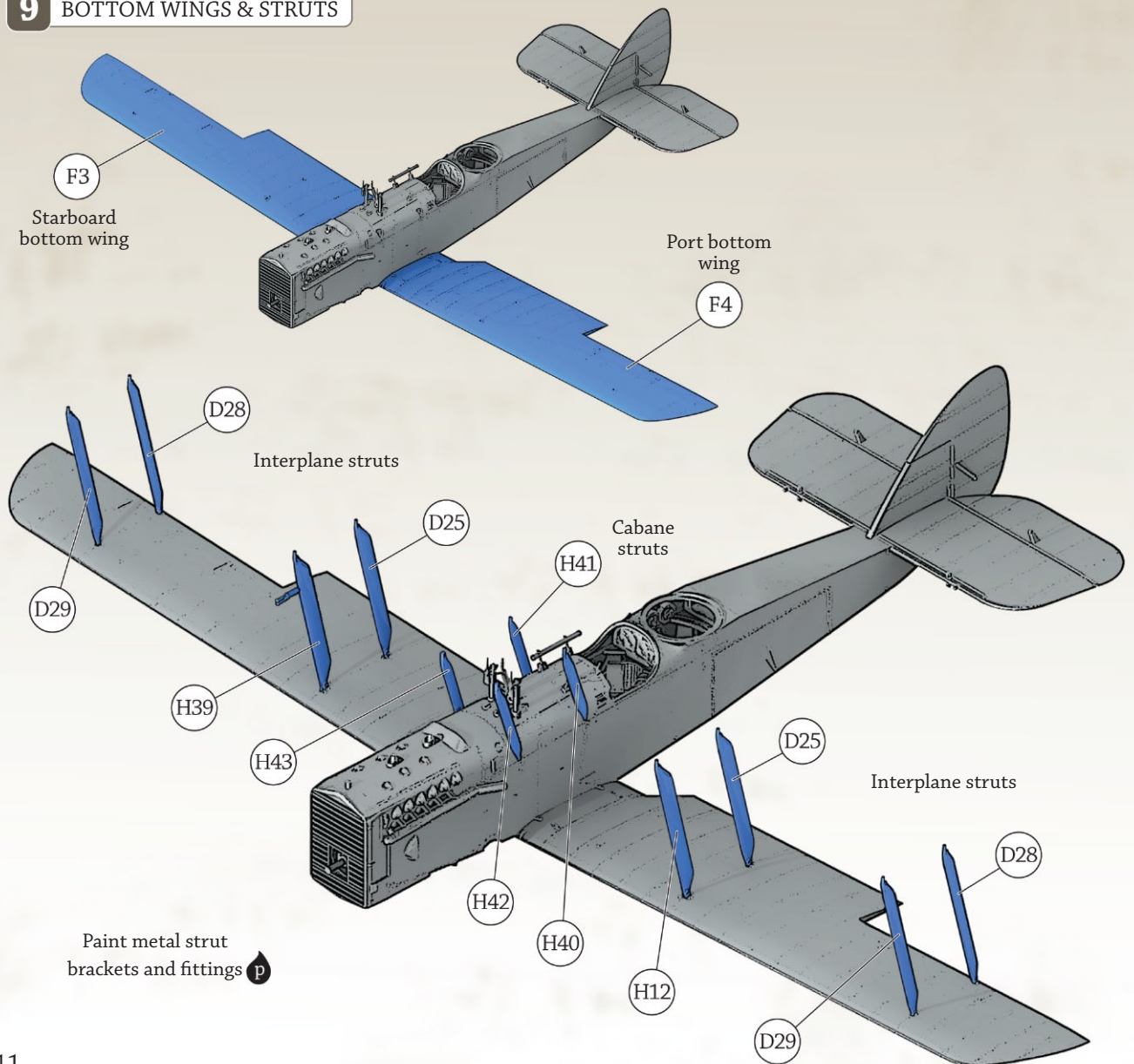

10 TOP WINGS

Leading edge slats possibly fitted to DH.9a A1-17 **D ?**

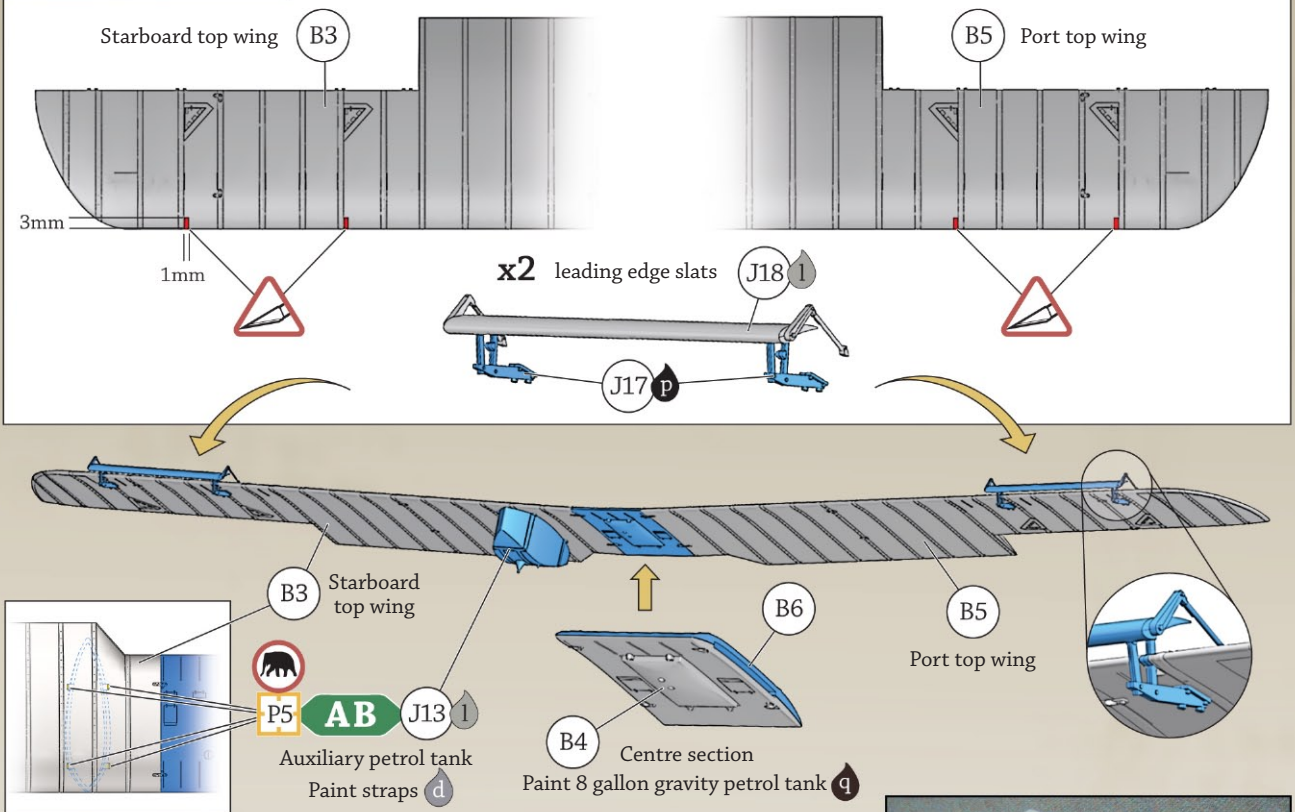

Invert model to attach upper wings. Use liquid glue for plastics. Glue cabane struts before wing struts.

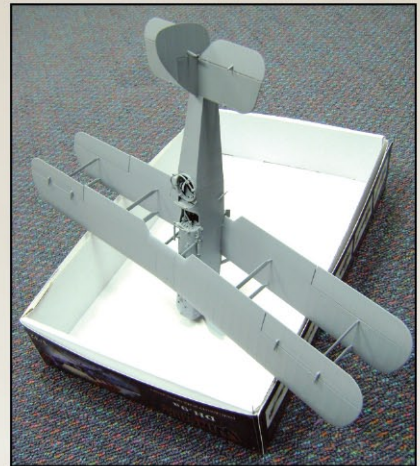
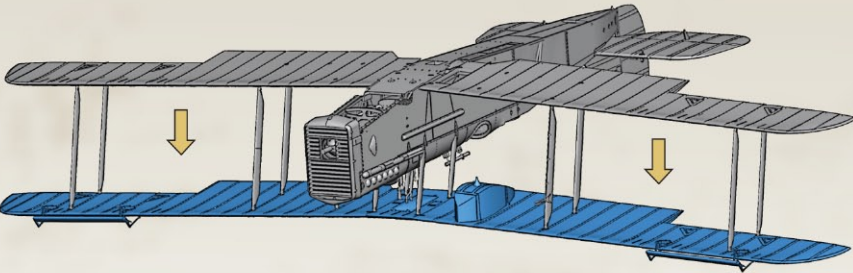

> Place model in empty box lid as shown while the glue dries to ensure correct alignment of the wings.

11 UNDERCARRIAGE

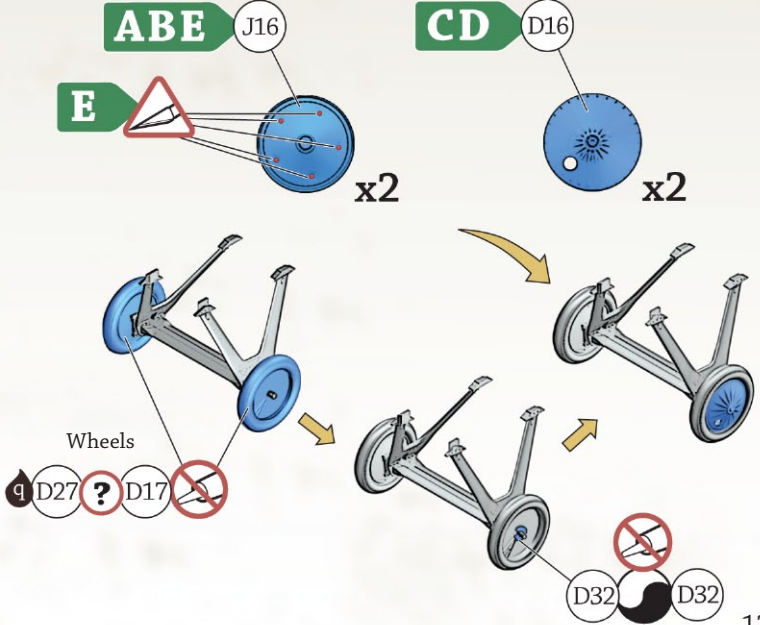
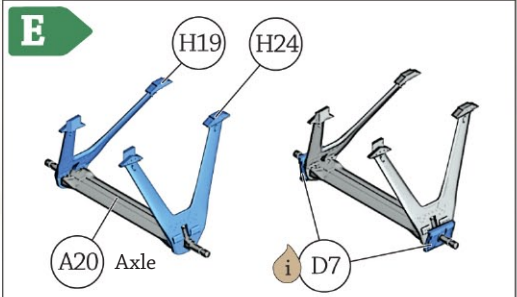
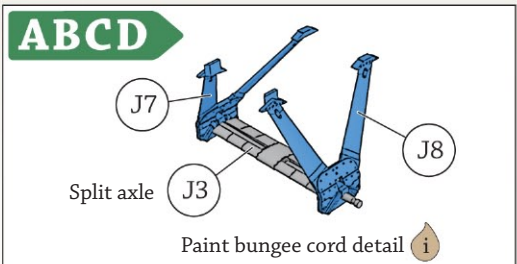

UNDERCARRIAGE continued

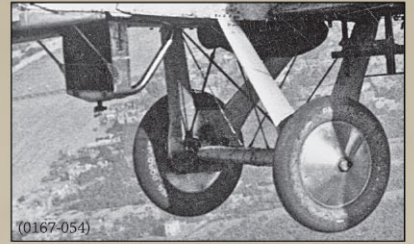

Undercarriage detail from Westland built DH.9a H3510 **B**. Note the additional rigging, auxiliary radiator and bare aluminium wheel cover.

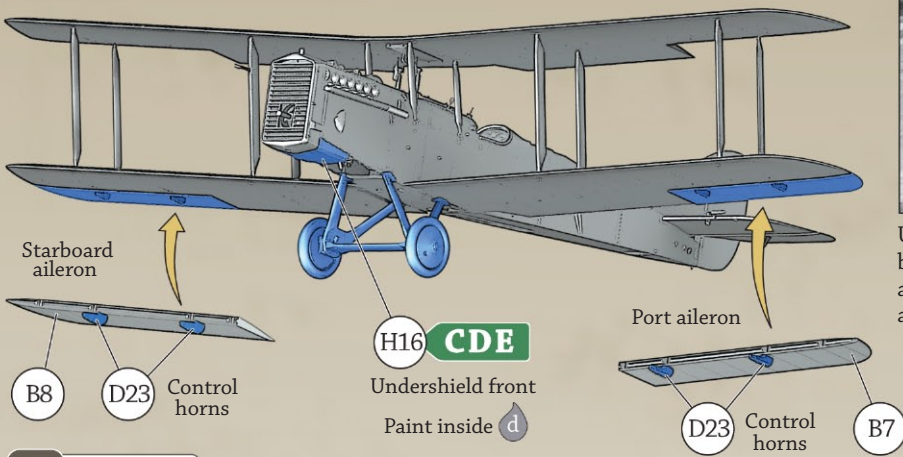

12 DETAILS

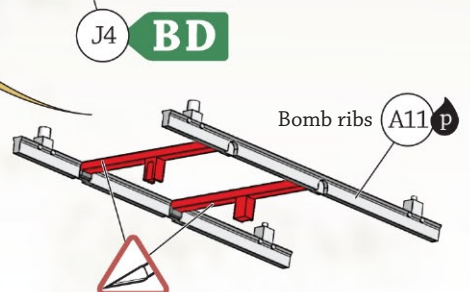
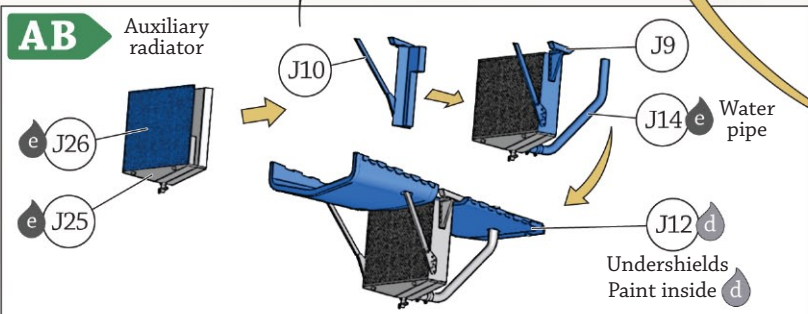
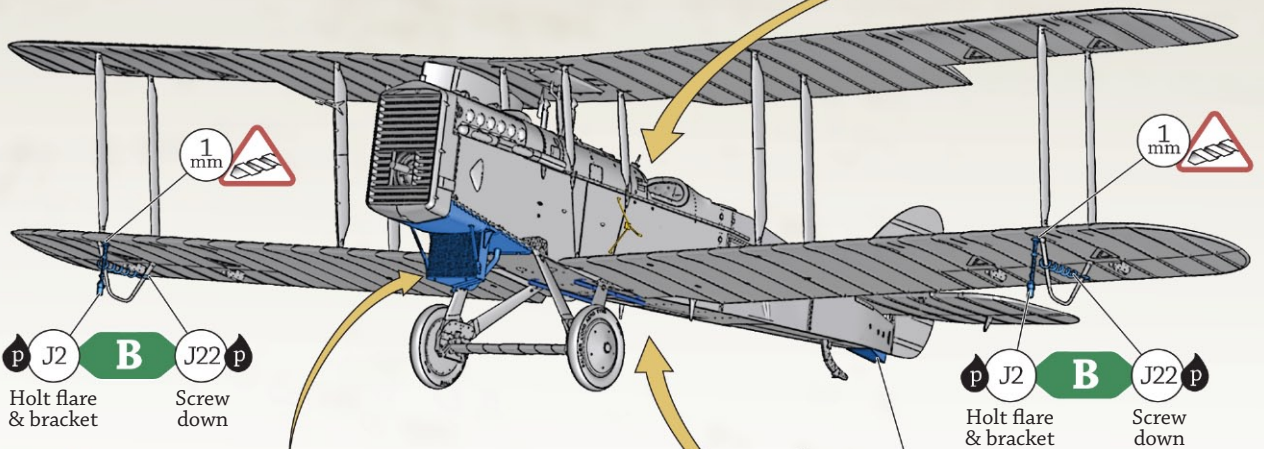
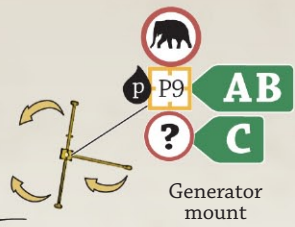
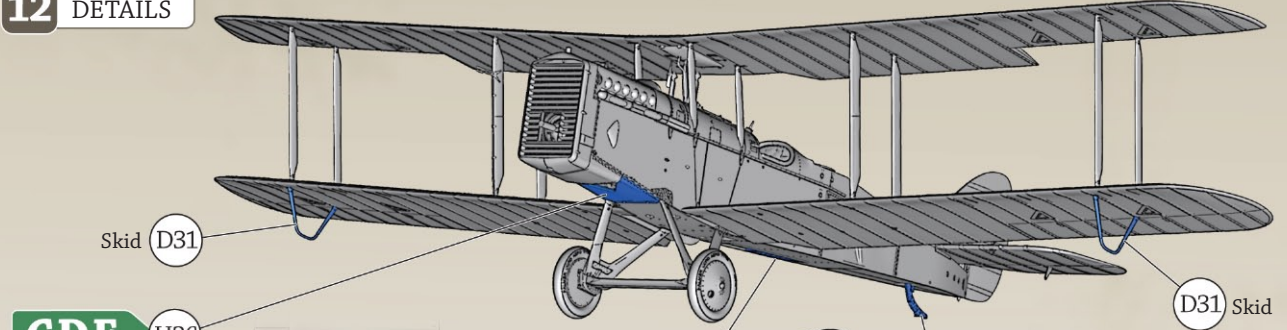

13 PROPELLER & BOMBS

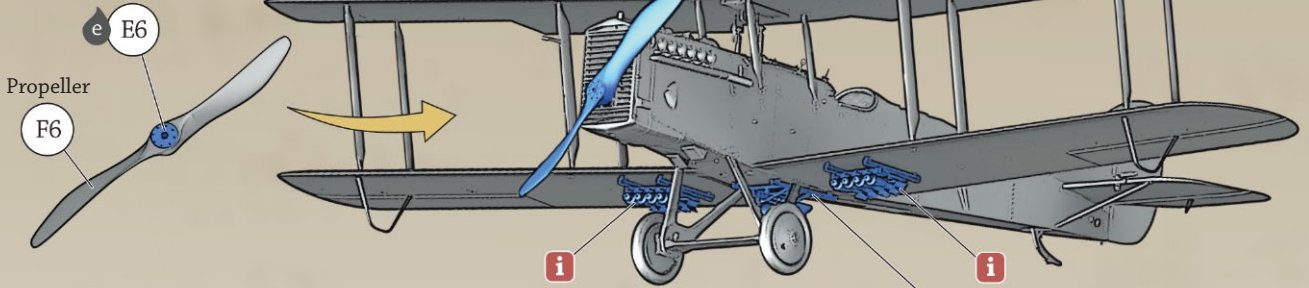

OPTIONAL BOMBS AND CARRIERS

ABCD i 20lb Cooper bombs & carrier

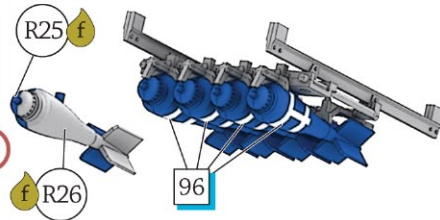
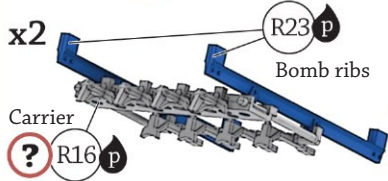

? ii ? iii ? iv ? v



20lb Cooper bombs as carried by the DH.9a

AB ii Double 100-112lb HERL bombs & Carrier 112lb Twin Mk.1

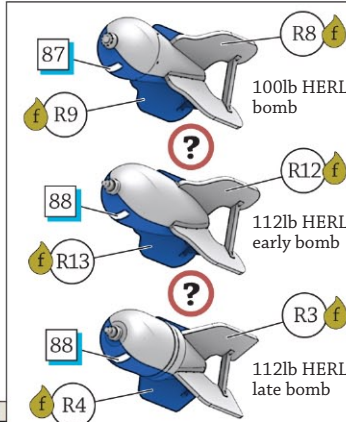
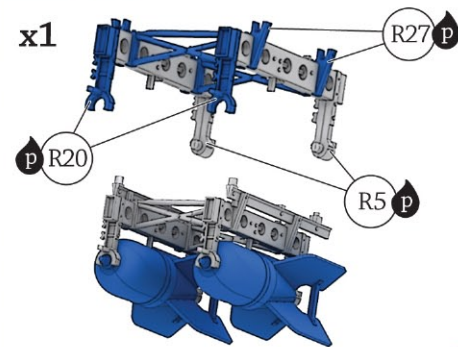

100lb HERL bomb.

AB iii Single 100-112lb HERL bombs & Carrier 112lb Single Mk.II

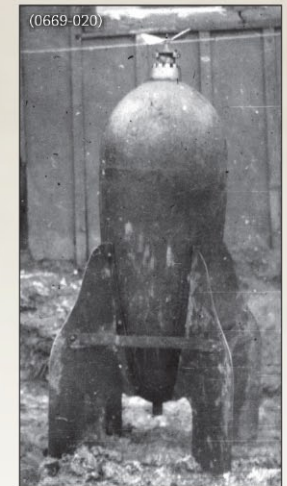
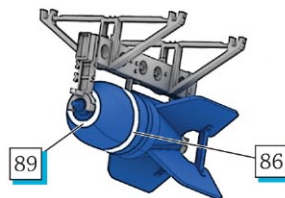
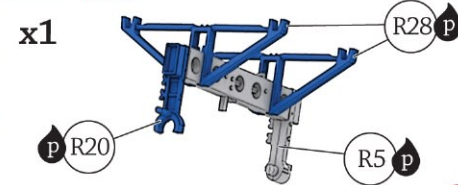

Early 112lb HERL (High Explosive Royal Laboratory) bomb.

AB iv Single 230lb HE Mk.1 bomb & Carrier 230lb Single Mk.1

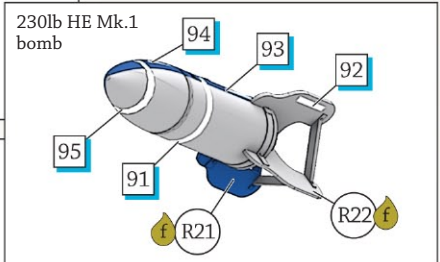
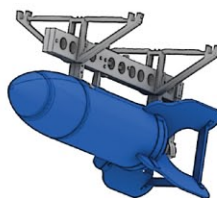
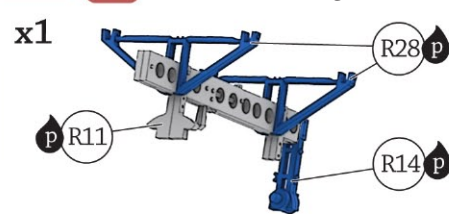

AB v Double 230lb HE Mk.1 bombs & Carrier 230lb Twin Mk.II

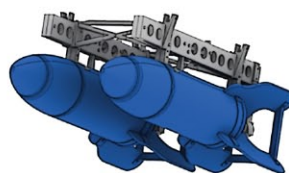
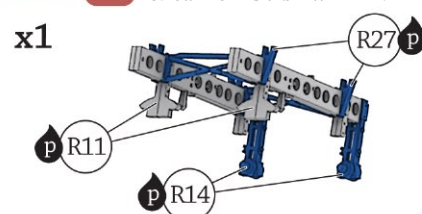

14 LEWIS GUN & SCARFF RING

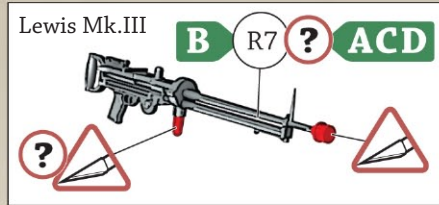
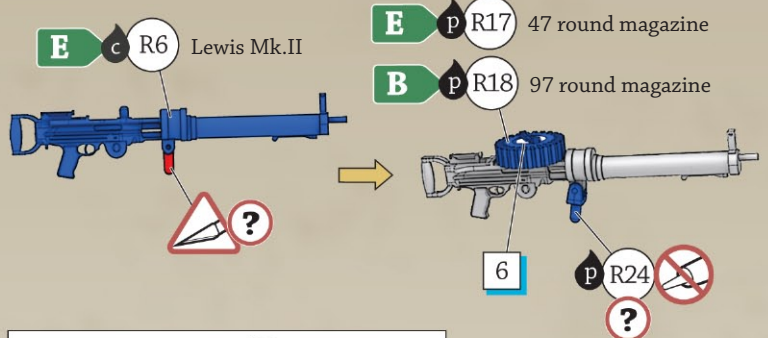
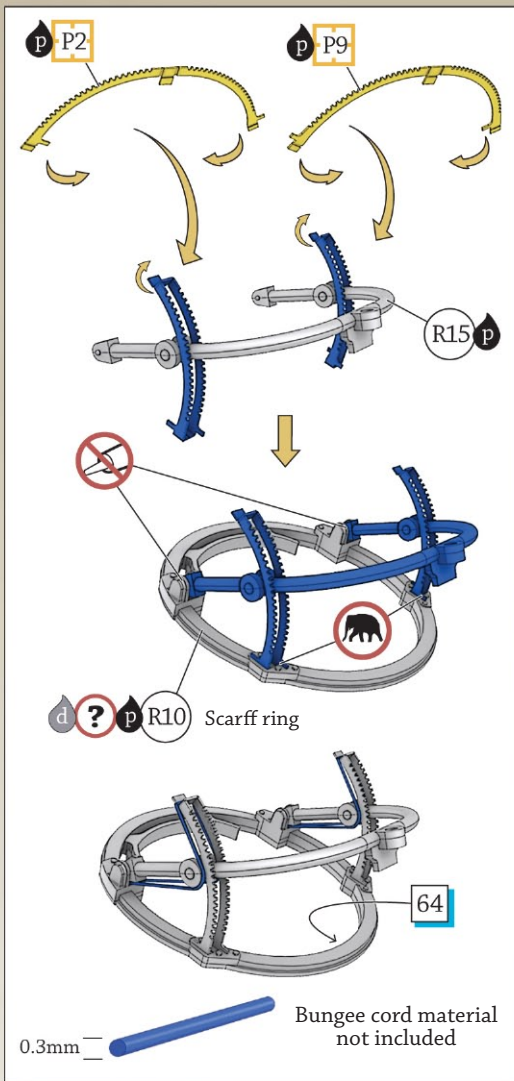

Add **R24** for increased movement

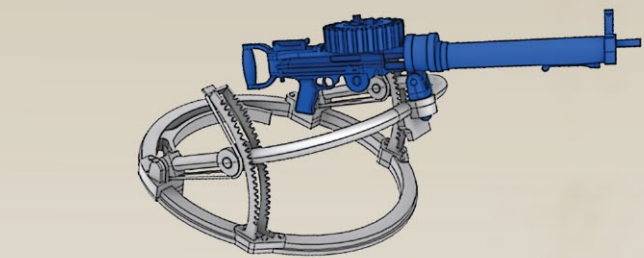

15 FINAL ASSEMBLY

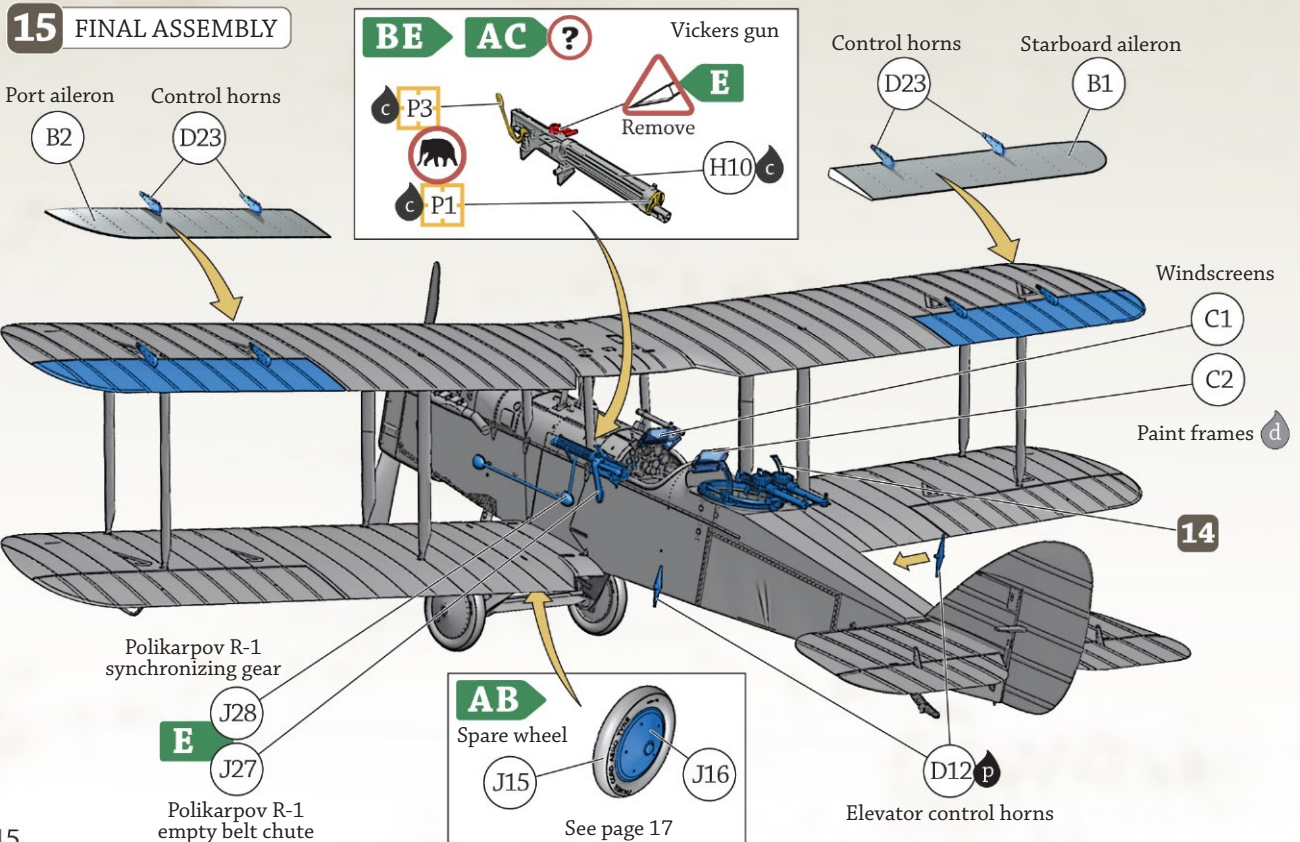

Rigging material not supplied

B
41

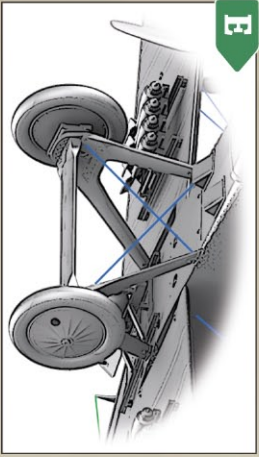
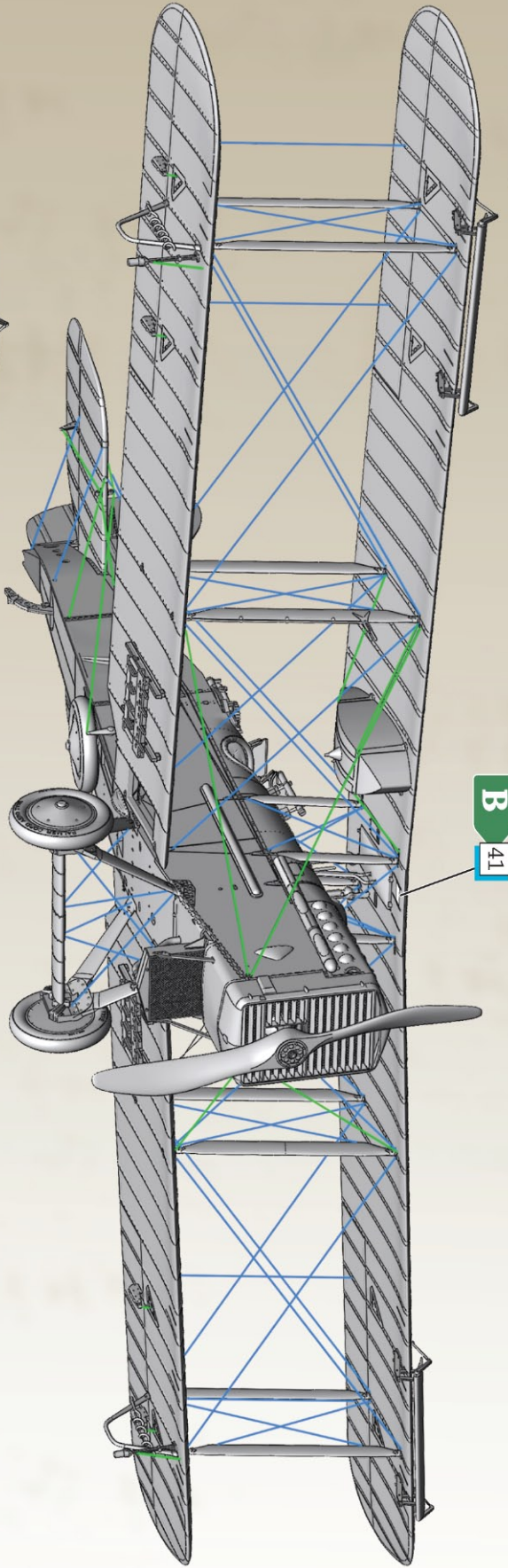

E

RAF Aerodynamic wires

0.1mm —
0.3mm —



A DH.9a E9939, Vulcan built, 8 Sqn RAF, Iraq, mid 1920s

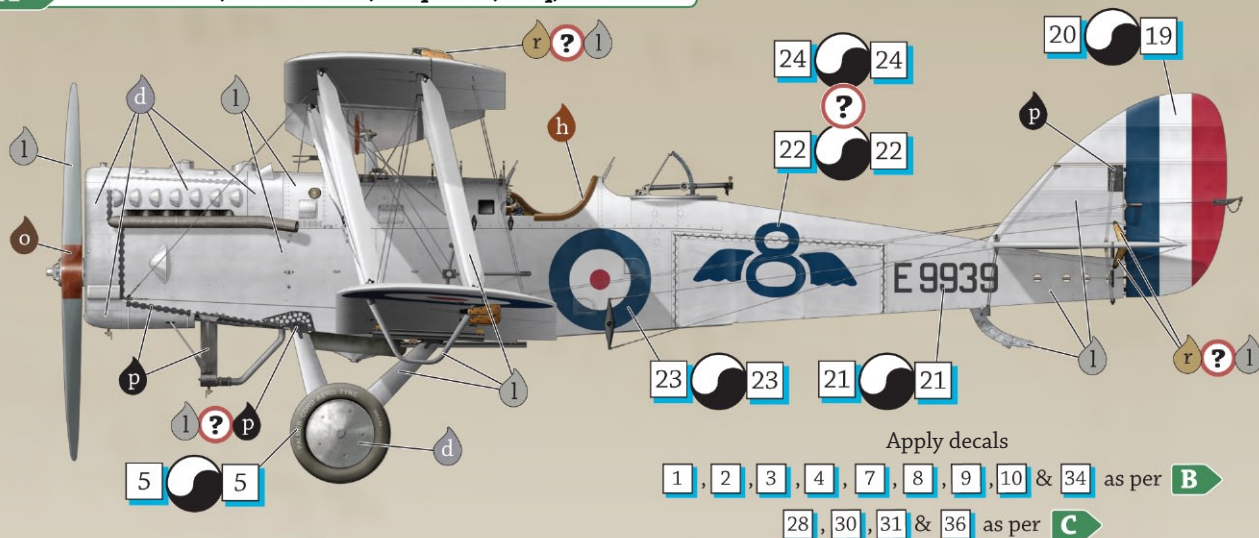

DH.9a E9939 was from a production order for 100 aircraft placed in March 1918 with The Vulcan Motor & Engineering Company (numbers E9857 to E9956) and was initially placed in storage before being delivered to Hinaidi near Baghdad in February 1924. It served in 55 Sqn and then 8 Sqn, as it is seen here, before being allocated to 39 Sqn in 1928. DH.9a E9939 was unarmed when it was photographed in flight and appears to have been doped silver overall with bare aluminium engine cowlings and wheel covers. Fuselage hinges are black as is the empty generator bracket (and possibly the undercarriage brackets too). The 'winged 8' Sqn fuselage marking may have been black or possibly blue and we have provided both colours for you to choose from.

B DH.9a H3510 'L', Westland built, AC Jones-Williams & Benson, B flight, 8 Sqn RAF, Iraq, 1923 to 1924

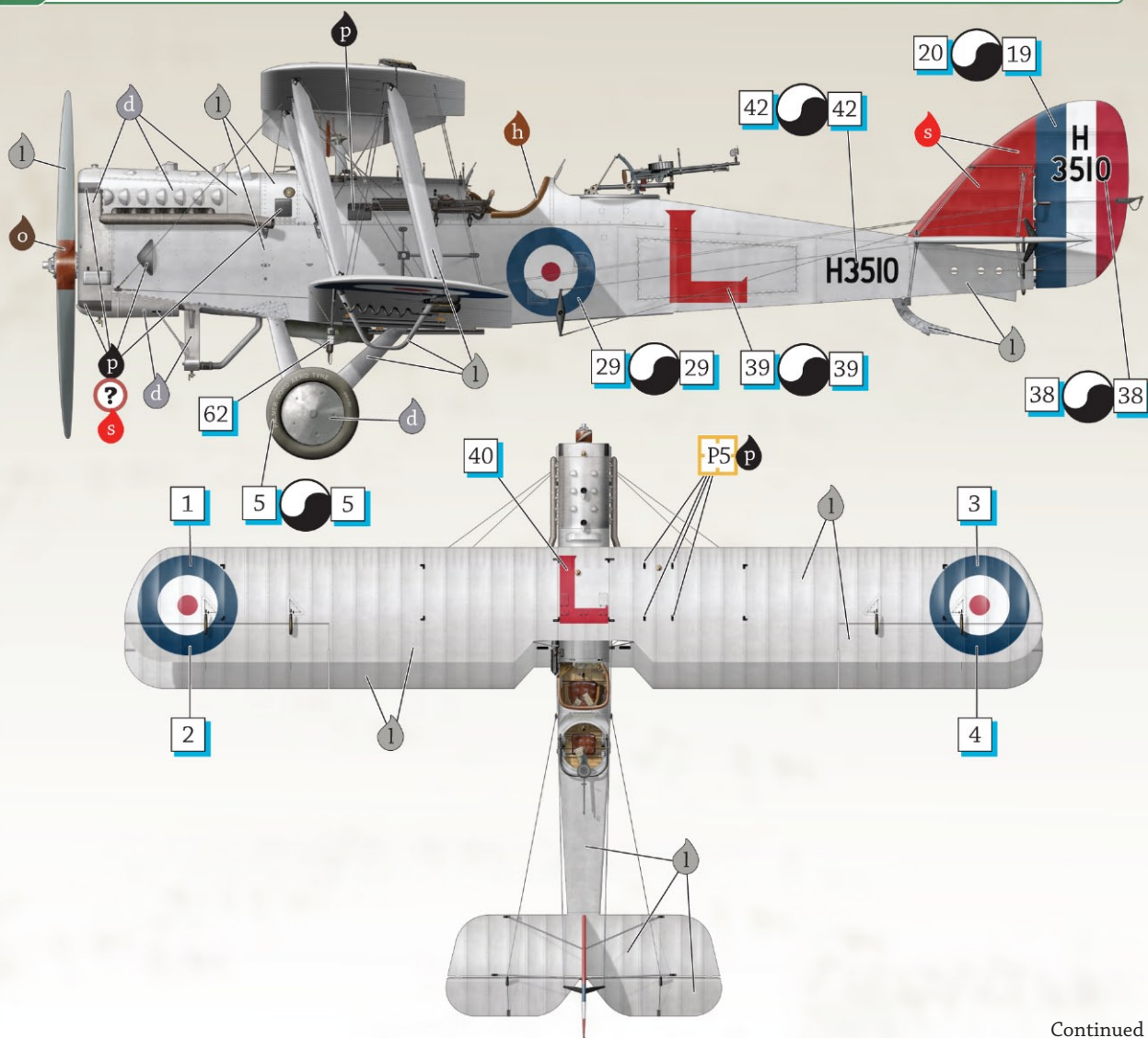

Continued >

B Continued

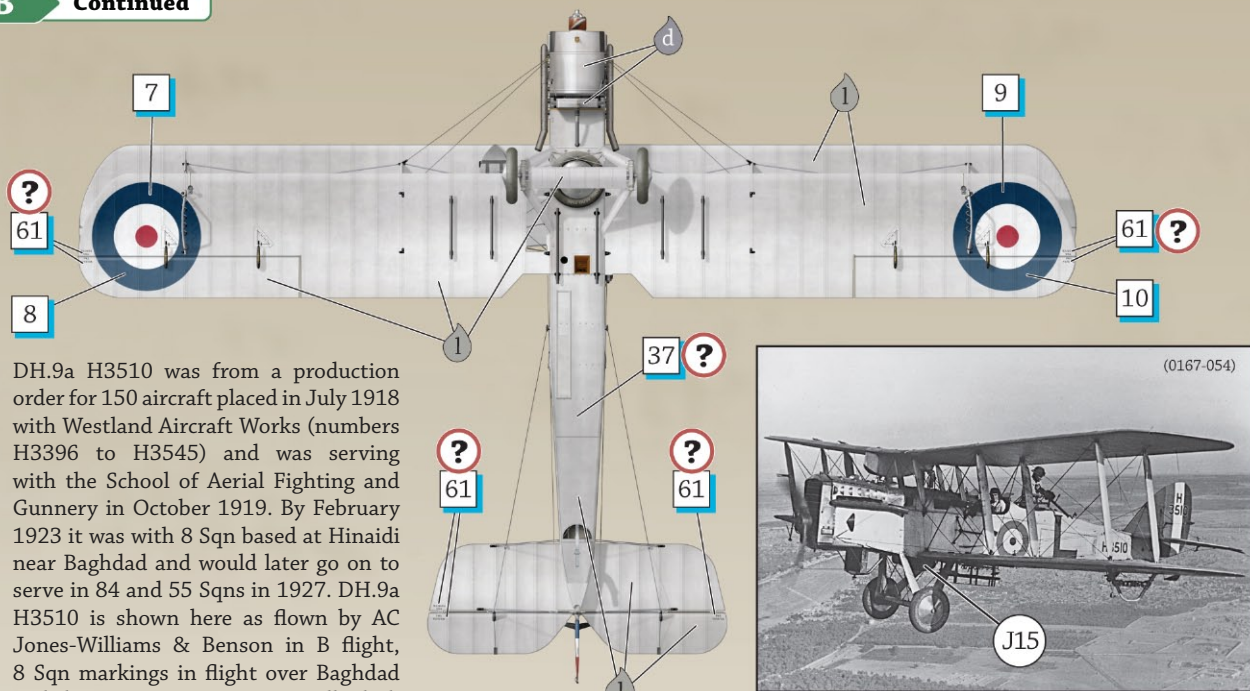

DH.9a H3510 was from a production order for 150 aircraft placed in July 1918 with Westland Aircraft Works (numbers H3396 to H3545) and was serving with the School of Aerial Fighting and Gunnery in October 1919. By February 1923 it was with 8 Sqn based at Hinaidi near Baghdad and would later go on to serve in 84 and 55 Sqs in 1927. DH.9a H3510 is shown here as flown by AC Jones-Williams & Benson in B flight, 8 Sqn markings in flight over Baghdad and the Tigris river. The unusually dark appearance of the top of the nose and upper surfaces of the wings is probably an optical illusion as all available references indicate that these aircraft were silver overall. The B flight fin marking and fuselage letter 'L' appear to red. Note the spare wheel lashed under the fuselage, Lewis Mk.III (R7), modified fuselage fabric stitching, auxiliary petrol tank (J13), empty 20lb Cooper bomb carrier, generator mount (P9), Holt flares (J2) and wing 'screw downs' (J22). The large empty brackets under the wings were sometimes fitted to carry extra stores.

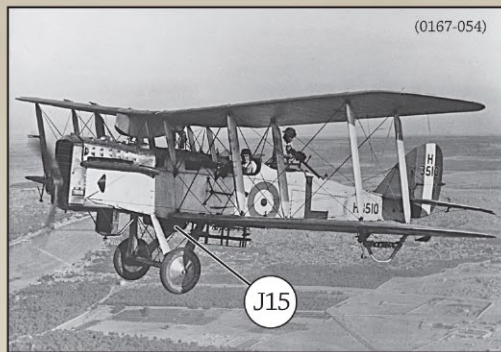
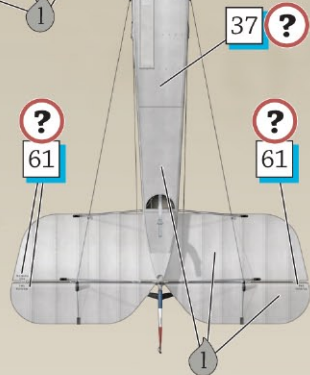

C DH.9a H3552, Vulcan built, 39 Sqn RAF, UK, June-July 1923

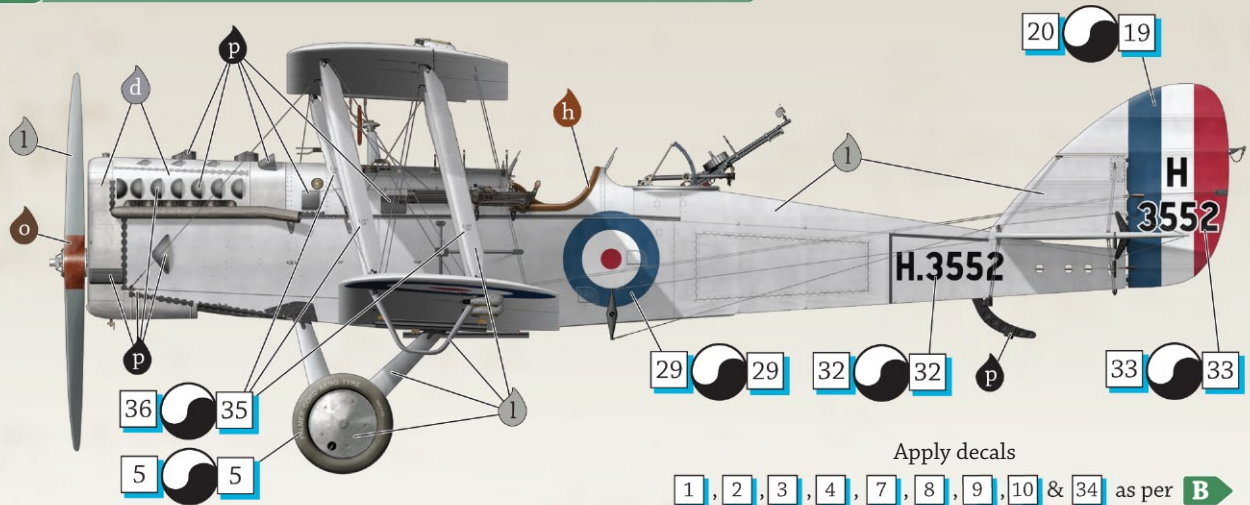

DH.9a H3552 is seen here in flight accompanied by fellow 39 Sqn 'Ninaks' E876, E948 and E8654 (not visible) in June or July 1923, probably during preparations for, or possibly while at, the Hendon Air Pageant on 30 June 1923. 39 Sqn was formed in April 1916 being tasked with home defense duties but by October 1918 it had been retrained and sent to France with aging FE.2b bombers where it was disbanded less than a week after the Armistice. It was reformed in 1919, returning to service in 1921 training on Avro 504s before being reequipped with the DH.9a in early 1923. DH.9a H3552 was from a production order for 250 aircraft placed in July 1918 with Vulcan (numbers H3546 to H3796) and was delivered to 39 Sqn in June 1923 just in time to be used in the squadron display at Hendon. The following month it was transferred to 5 Flight Training School where it was involved in landing accidents with Avro 504Ks in November 1923 and January 1924 before being returned to 39 Sqn later that year. Note the dark painted metal brackets, hinges & fittings, bare aluminium engine cowlings, modified fuselage fabric stitching and small stencil details on the fin, rudder and interplane struts.

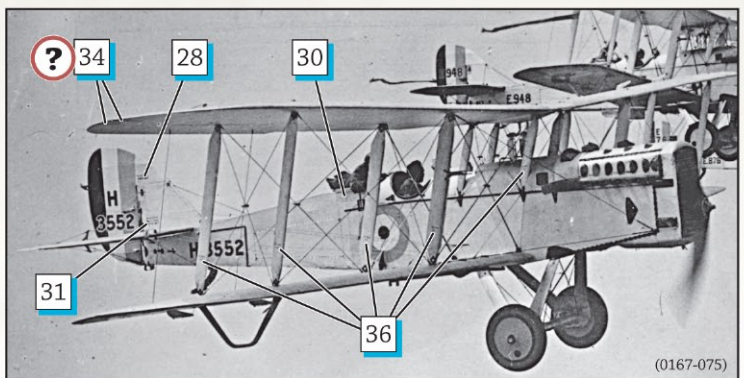

D1 DH.9a A1-17, Berwick built, E Flight, 1 FTS RAAF, Australia, 1922

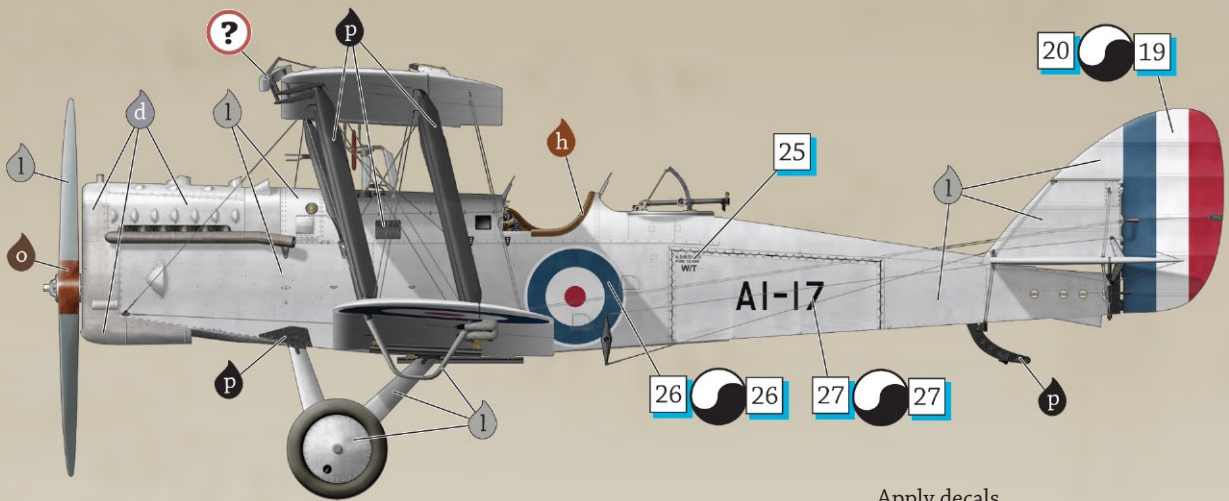

Apply decals

11, 12, 13, 14, 15, 16, 17 & 18 as per **B**



DH.9a A1-17 (originally F2779) was from a production order for 170 aircraft placed in April 1918 with F.W.Berwick & Co (numbers F2733 to F2902) and was completed in April 1919. DH.9a F2779 was one of 30 DH.9a allocated to Australia as part of 100 aircraft supplied under the Imperial Gift scheme and had arrived down under at the Central Flying School Australian Air Corps by May 1920. The following month it set an Australian altitude record of 27,000ft. By the time of the formation of the Australian Air Force on 31 March 1921 it had been renumbered A1-17 and was serving with 1 Flight Training School. The photo above appears to show DH.9a A1-17 and A1-26 of E Flight 1 FTS in 1922. Note the lack of armament, empty bomb ribs, dark interplane & cabane struts and unpainted aluminium engine cowlings. DH.9a A1-17 was reconditioned in 1925-1926 and again in 1928 and continued to serve with 1 FTS until being written off in February 1930.



The photos above show the reconditioned DH.9a A1-17 following one of its 4 landing accidents during 1929. By this time A1-17 had been upgraded with leading edge wing slats (J18), oleo undercarriage and cellon window in the fuselage under the observer's cockpit. It is not entirely certain if the leading edge wing slats were added before the modified fuselage and oleo undercarriage or at the same time so it is remotely possible that they could be suitable for this model.

E Polikarpov R-1 'AMYPA', 19th Special Aviation Group, USSR, 1929



Polikarpov R-1 'AMYPA' of the 19th Special Aviation Group (19-й Отдельный Авиационный Отряд) as used during the Soviet-Chinese conflict of 1929. At least 2700 unlicensed copies of the DH.9a were built in the Soviet Union as the Polikarpov R-1 during the 1920s. AMYPA appears to be finished in the 'standard' Soviet colours from this period with dark greenish khaki 'Zashchitnyi' protective paint upper surfaces and light grey-blue undersides. This colour scheme is based on 2 photos published in *FliegerRevue Extra* #24 2009, one showing the port side of the fuselage without the tailplane visible and another of the starboard side where the tailplane number 5 is visible which may possibly be the same aircraft, but we have included alternative '3' decals for you to use if you disagree. The striking fuselage slogans roughly translate as 'working people [46] of Amur [47] province' while 'ИИ'АА' is a war cry.



< AMC built DH.9a H72 'C' in service with 27 Sqn in 1921-1922 where it has been turned into an airmail furniture delivery vehicle. In addition to the bed and suitcase strapped to the rear of the fuselage there are bundles of stores slung from the wing bomb carriers. Note the starboard bottom wing cut out has been extended to the trailing edge and the engine side cowlings have been removed.

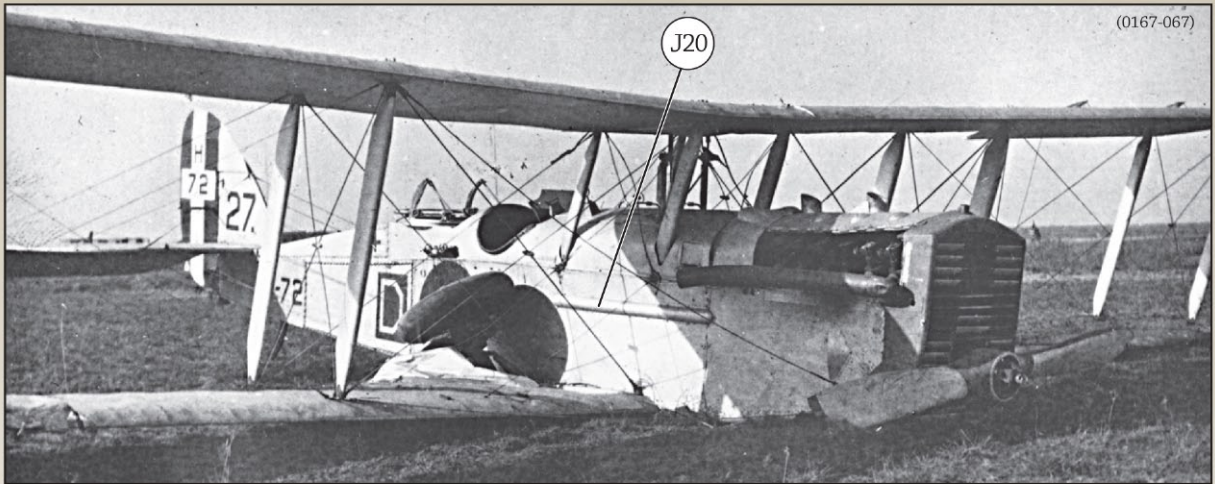

From a production order for 200 DH.9a placed with AMC in 4 July 1918 (numbers H1 to H200), H72 was completed too late to see action during the First World War but went on to a long career with 27 Sqn, 60 Sqn and HQ RAF in India until at least March 1930. Photographed following a crash landing, 27 Sqn DH.9a H72 now wears a silver dope finish and the letter 'D'. Note the checker board finish of the radiator shutters, external cable fairing (J20) and unpainted aluminium engine cowlings.

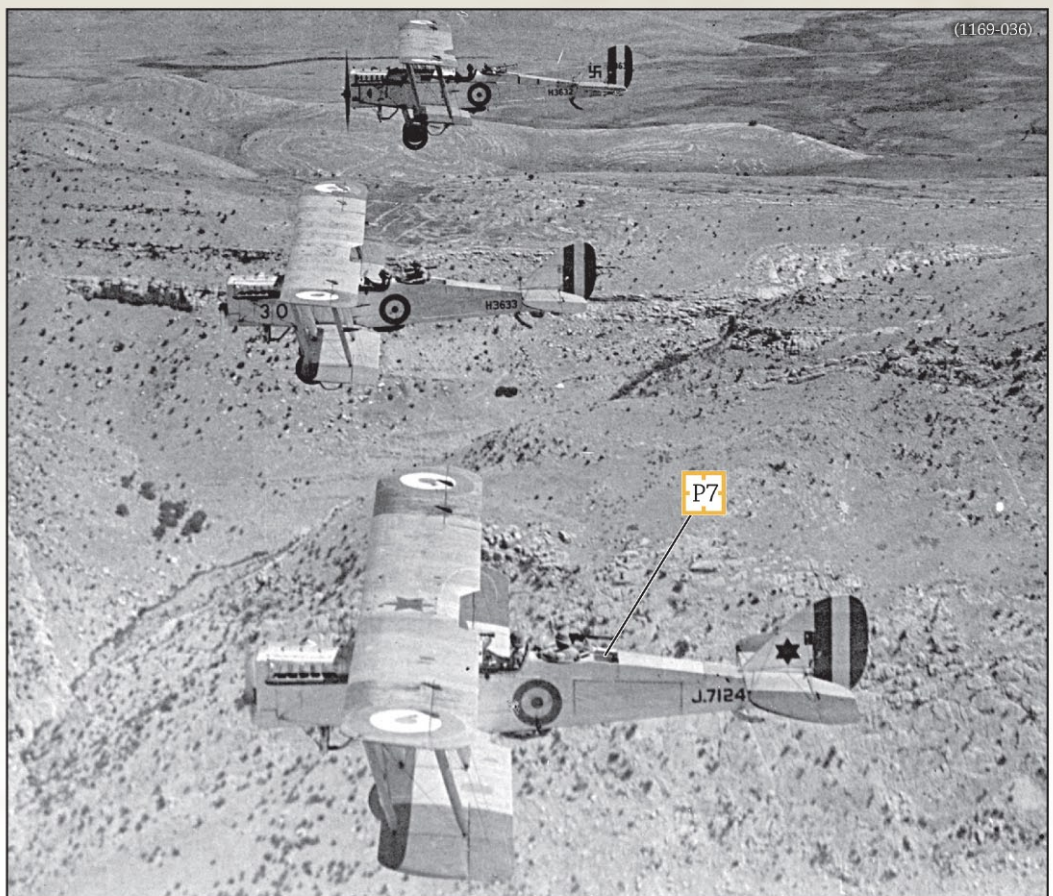

DH.9a H3632, H3633 and J.7124 of 30 Sqn in flight somewhere over Iraq in the mid 1920s. Note the open fuselage storage lockers (P7) and coloured wing tip markings.

(0167-058)



DH.9a E8622 was from a production order for 400 aircraft placed in March 1918 with AMC (numbers E8406 to E8806) and is seen here while in service with 8 Sqn in 1926-1927. It's appearance is remarkably similar to fellow 8 Sqn DH.9a H3510 **B** as seen on page 17. Note the auxiliary gravity petrol tank (J13), radiator (J25) and the external cable fairing (J21).



3-D Modelling by Nick Moore

Nick Moore is an industrial design graduate and experienced scale modeller with a longstanding interest in most periods of history. Before entering this project he knew less about WW1 aviation than later periods and was surprised at the innovations achieved during this time. His investigation of WW1 aircraft has encouraged further interest in the aircraft of the 'Golden Age' of the 20's and 30's which have particularly beautiful forms.

The 3D design challenge he found in creating the Wingnut Wings models is adapting the real aircraft to scaled down replicas with the necessary adjustments for injection moulding, when of course, as a modeller - he would like 100% reality.

Nick was at one time a private pilot but never took the controls of a bi-plane - the oldest plane he was rated in was that classic old tail dragger, the Piper Cub. These days most of Nick's spare time is spent with his young family.

Additional 3-D modelling by Darren Mildenhall



Profile Art by Ronny Bar

Ronny Bar developed a keen interest in airplanes from an early age, living close at the El Palomar Air Force Base in Buenos Aires. He first flew in the back seat of a T-34 Mentor trainer at the age of ten, and was soon drawing airplanes and building models: Spitfires and Messerschmitt first... Camels and Fokkers later.

He became a successful bass player with a career lasting over 35 years in several Rock bands, recording ten albums (one of them being a National hit selling more than 100,000 copies) and performing countless concerts, TV shows and tours all over Argentina.

Now retired from the R'n'R scene, his interest returned to his early passion: Aviation Artwork. Visiting the WW1 aircraft collection at Hendon focused his already growing interest for that historic period. His artwork is regularly appearing in journals and publications like Windsock Worldwide, Windsock Datafiles, Cross & Cockade and Over the Front.

Visit Ronny's website at: www.ronnybarprofiles.com



Project Co-ordinator, Richard Alexander

A native of Wellington New Zealand, Richard Alexander has a long term interest in military history, race cars & local drivers from motor sports golden era of the '60's. Other interests include mountain biking, scotch and cigars.

An accomplished modeller Richard's models have twice been awarded Best Overall in Show at IPMS(NZ) National Conventions and earned him the inaugural TamiyaCon(NZ) Master Modeller award (along with the associated trip to Japan) in 2001. Many of his works are in private collections around the world, though he no longer accepts commissions.

Richard has been in the model and hobby industry since 1991 and brings with him a keen eye for detail and a passion for ensuring our models are enjoyable to build. So if there is anything you don't like about this model, you can blame him.

If you do have comments, requests or suggestions, Richard is contactable at richard@wingnutwings.com



Box Art by Steve Anderson

Steve Anderson is an avid historian of military aviation, with a special interest in the many beautiful biplanes and triplanes of World War I. The aircraft and battles of famous World War I aces such as Baron Manfred von Richthofen (better known as the "Red Baron"), James McCudden, Raoul Lufbery, Ernst Udet, Werner Voss, and other pioneers of dogfighting are among Steve's favorite subjects.

An Artist Fellow of the American Society of Aviation Artists, Steve creates works that reflect scrupulous attention to historically accurate detail, from the colorful markings on the fuselages to the time of day of an actual battle.

Visit Steve's website at: www.anderson-art.com.



32061	1/32 DH.9a Post War	Qty
0132007A	A parts	1
0132007B	B parts	1
0132007C	C parts	1
0132007D	D parts	2
132E0008	E parts Liberty V12 Engine	1
0132007F	F parts	1
0132007G	G parts	1
0132007H	H parts	1
0132061J	J parts	1
0132061P	Photo-etched metal parts	1
132R0002	R parts RFC Armaments	2
7132061	Instructions	1
9132061	Decals	1

If you have any damaged or missing parts please contact help@wingnutwings.com for assistance.



32038 - 1/32 Salmson 2-A2 / Otsu 1



32035 - 1/32 AMC DH.9



32054 - 1/32 Sopwith Snipe Late

Also available from
www.wingnutwings.com

©2015 Wingnut Wings Ltd. PO Box 15-319 Miramar, Wellington 6022 New Zealand.
 All rights reserved. Designed in New Zealand - Manufactured in China.