

L7201
1/72 SCALE

G.W.H.[®]



U.S. AIRFORCE F-15E

IN ACTION OF OEF&OIF 美国空军F-15E“攻击鹰”战斗机

USAF addressed a requirement of a new long-range strikefighter to replace the General-Dynamic F-111 series fighter-bombers in march,1981. McDonnell Douglas take a design based on F-15 twin-seater, which equipped with a pair of conformal fuel tanks (CFT) to get a longer combat range, and have a newly designed structure. McAir's new fighter named F-15E. At the same time, General Dynamic put out the F-16XL for competition, which prolong the fuselage of the basic F-16 and use big arrow wings instead of the original main wings and horizontal tails. Both new fighters can make long range attack which USAF expected. In the year 1985, Israel Air Force use

modified F-15Ds (Add CFTs and necessary avionics) take heavy guided-bombs made a very long range raid to the PLO headquarter in Tunisia, this successful attack provided a huge help to McAir's F-15E for the eventually victory. F-15Es continued the production of F-15s, after the air dominance Eagles off production. F-15E's derivative models were exported to many international users, such as Saudi Arabia's F-15S/SA, Israel's F-15I, Korean's F-15K and Singapore's F-15SG, etc. Nowadays, when USAF conduct air-to-ground attacks, F-15Es would arrive the battlefield. In the foreseeable future, Strike Eagles will remain to be the main power of the tactical strike in USAF.

1981年3月，美国空军提出了F-111战斗轰炸机后继机型的需求，麦道公司在F-15双座型飞机的基础上，加装了保形油箱，并对机体结构进行了脱胎换骨的改进，提出了F-15E“双重任务战斗机”方案，而通用动力公司则拿出了加长机体，改用箭形机翼无尾布局的F-16XL方案，二者皆可满足美国空军提出的远程打击的作战要求，在1985年，以色列用经过简单改装，加装保形油箱的F-15D双座战斗机，挂载重型制导炸弹，对远在突尼斯的巴解总部成功进行了令人难以置信的远程奔袭，这个战例无疑为麦道公司的方案送

上了“神助攻”，使该公司基于现有成熟机体研发的F-15E最终战胜对手，成功入选。在F-15C/D制空型战斗机停产后，接续了F-15系列战斗机的生产。后来，基于F-15E的各种改型出口到多个国家，例如出口沙特阿拉伯的F-15S/SA，出口以色列的F-15I，出口韩国的F-15K，出口新加坡的F-15SG等。现在，只要有美国空军参与对地打击的作战行动，就有F-15E的身影出现，在可见的将来，“攻击鹰”仍然是美国空军战术打击力量的绝对主力。



A PARTS x1

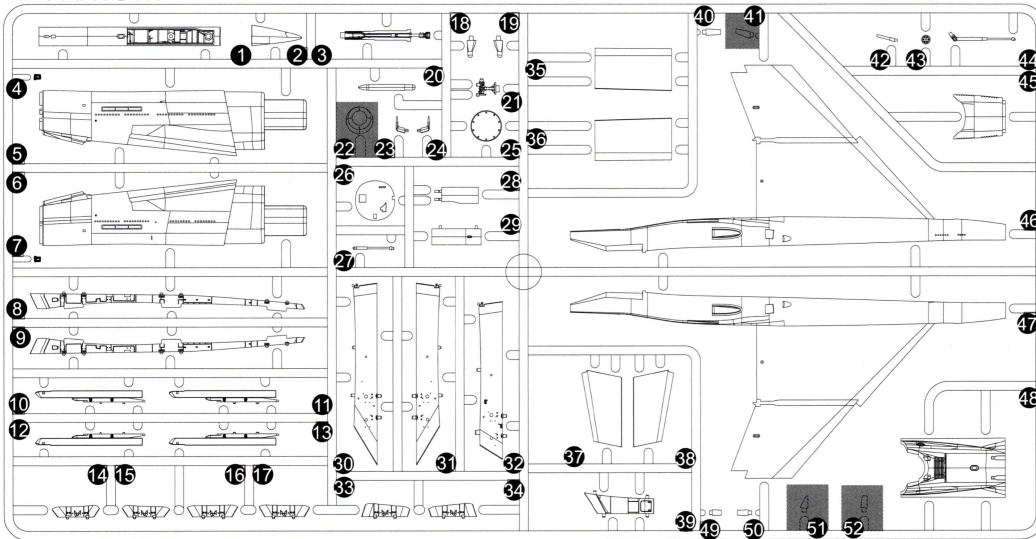

O PARTS x1

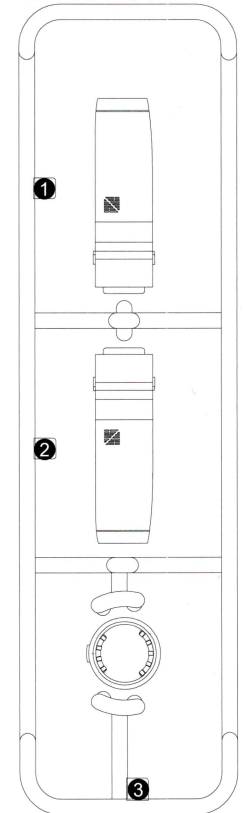

P PARTS x1

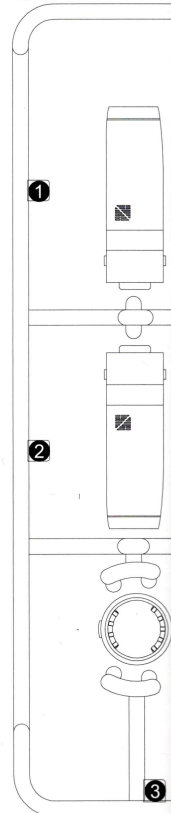

M PARTS x1

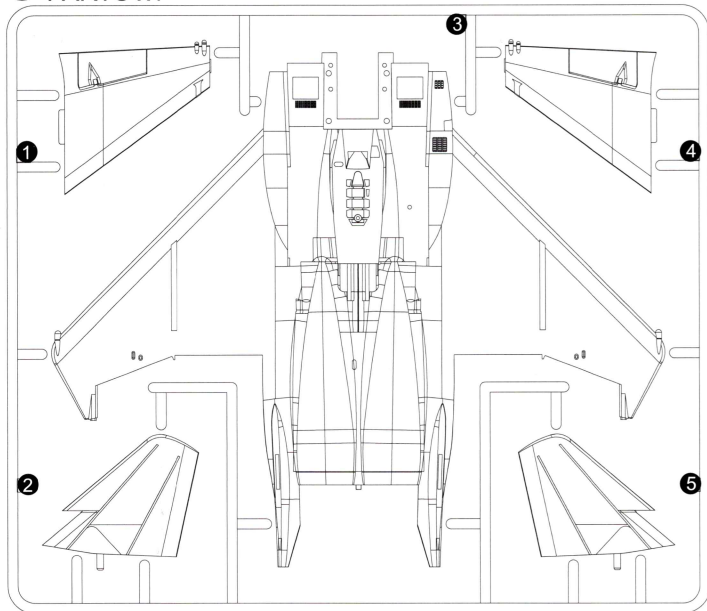

U PARTS x1

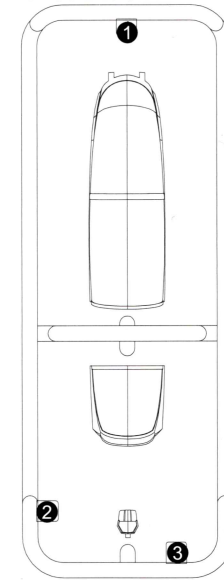

Q PARTS x1

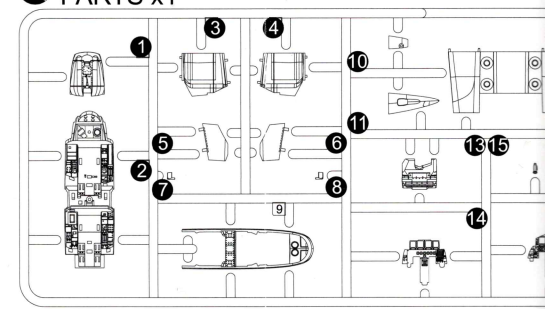

T PARTS x1

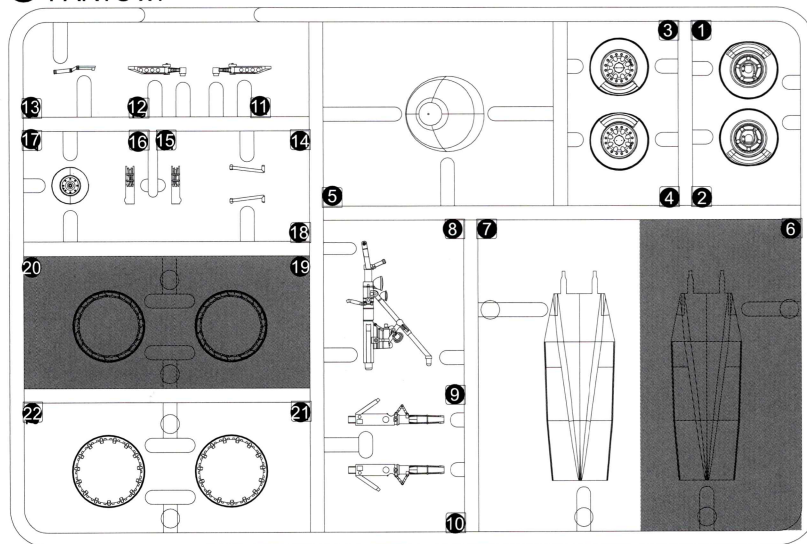

B GBU-12 x3

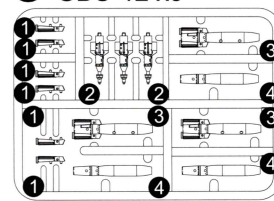

J AAQ-14 x1

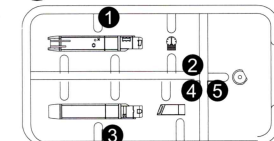

I AXQ-14 x1

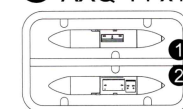

DE A



表 PARTS LIST パーツリスト

C PARTS x1



P PARTS x1

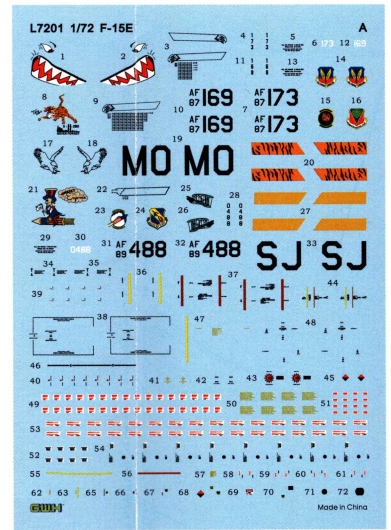
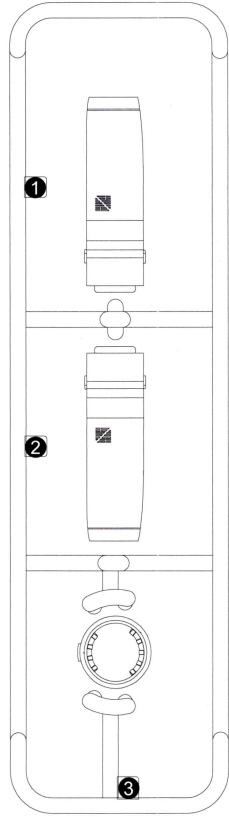
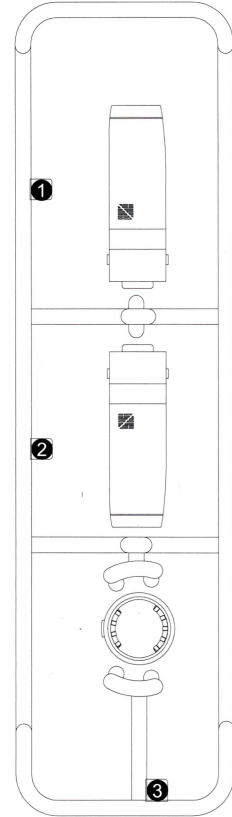

N PARTS x1

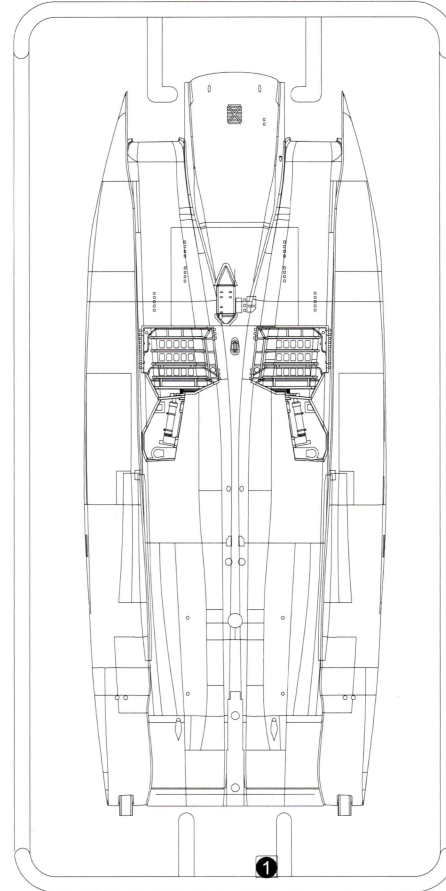

R PARTS x2

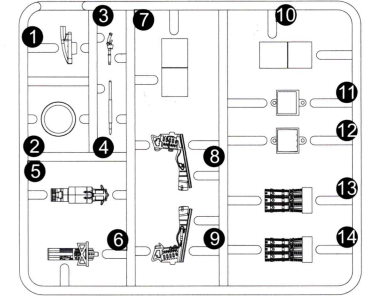

G GBU-15 x1

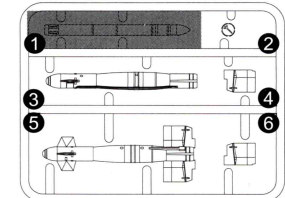

D AIM-9L/AIM-120B x2

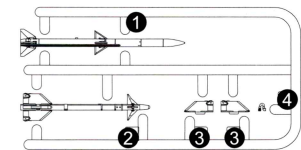

H AAQ-13 x1

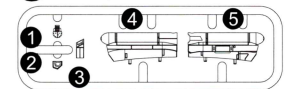

L 610GAI-FUEL x2

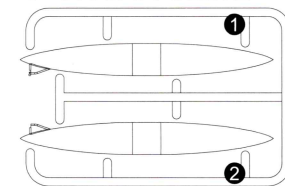

Q PARTS x1

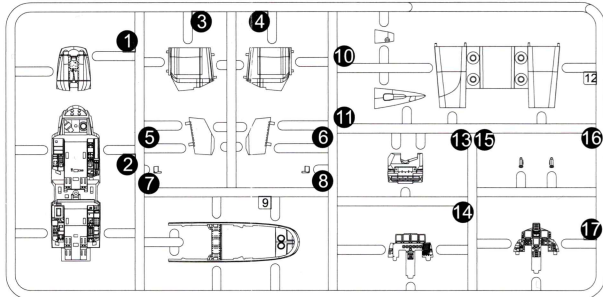

E GUB-24 x1

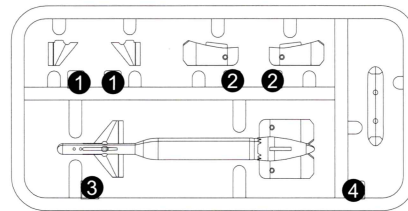

3

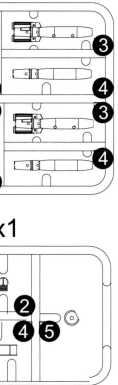

DE A

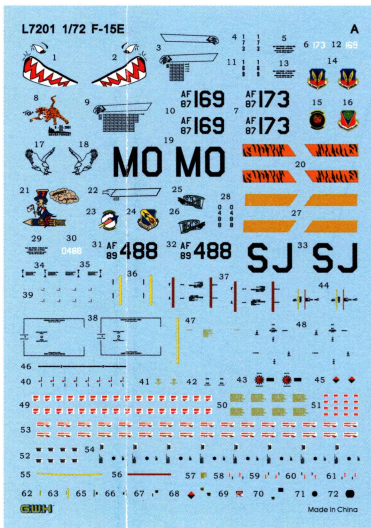

DE B

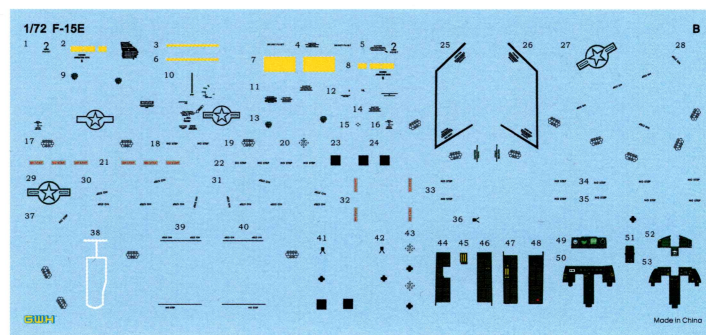

Parts not for use
不需要板件零件



1

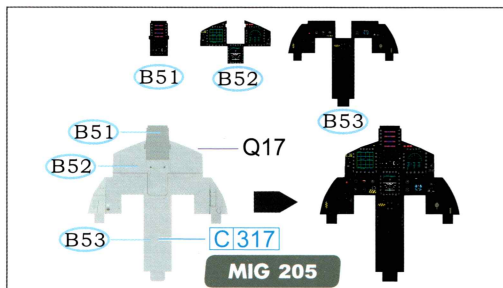
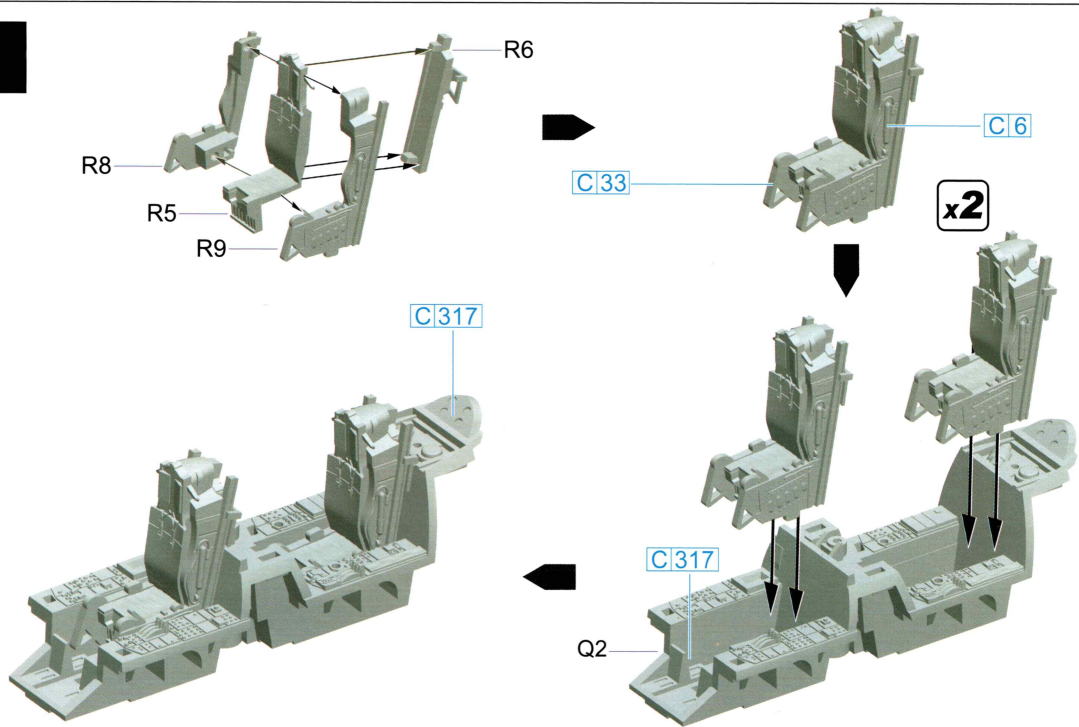

前仪表板
Front Instrument Panel
前にダッシュボード

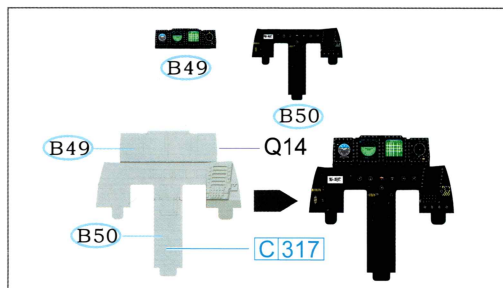

后仪表板
Rear Instrument Panel
後にダッシュボード

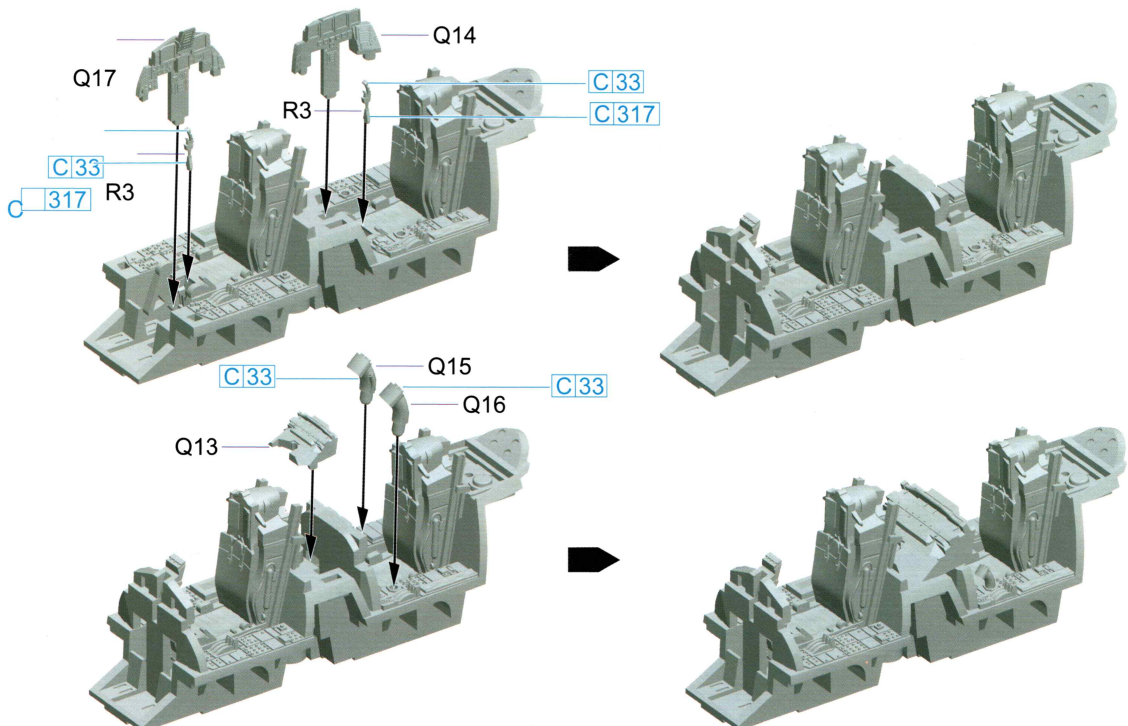

2

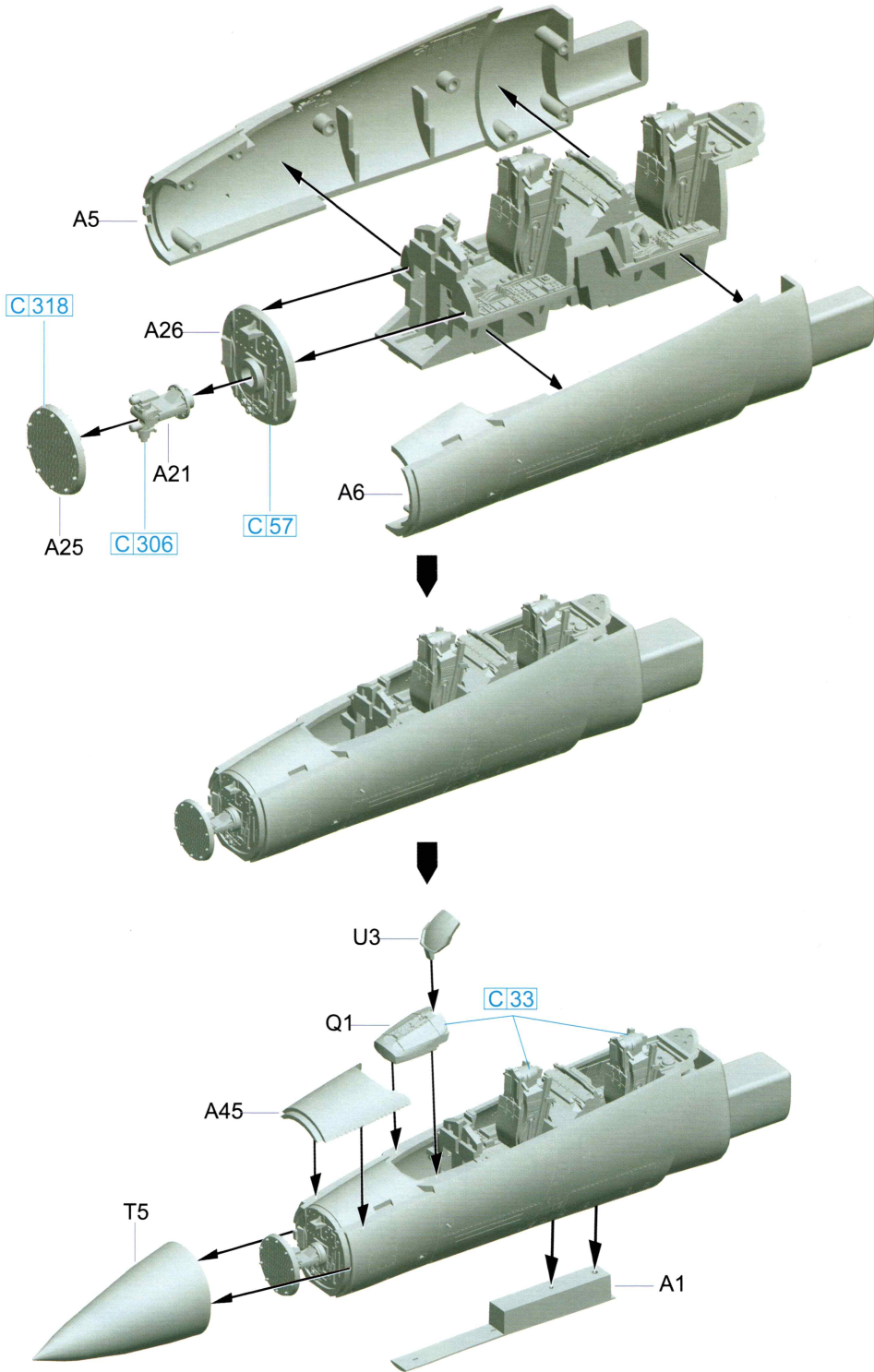

3

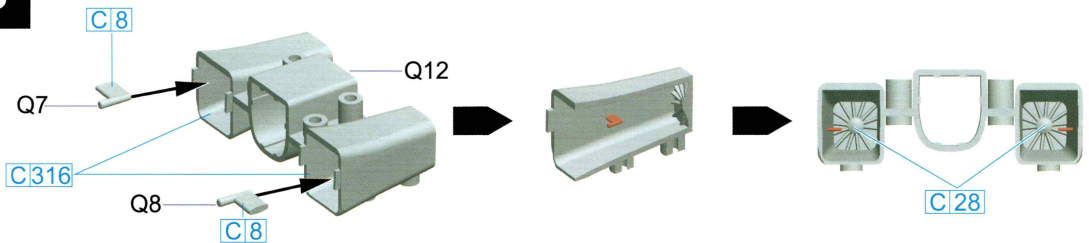

4

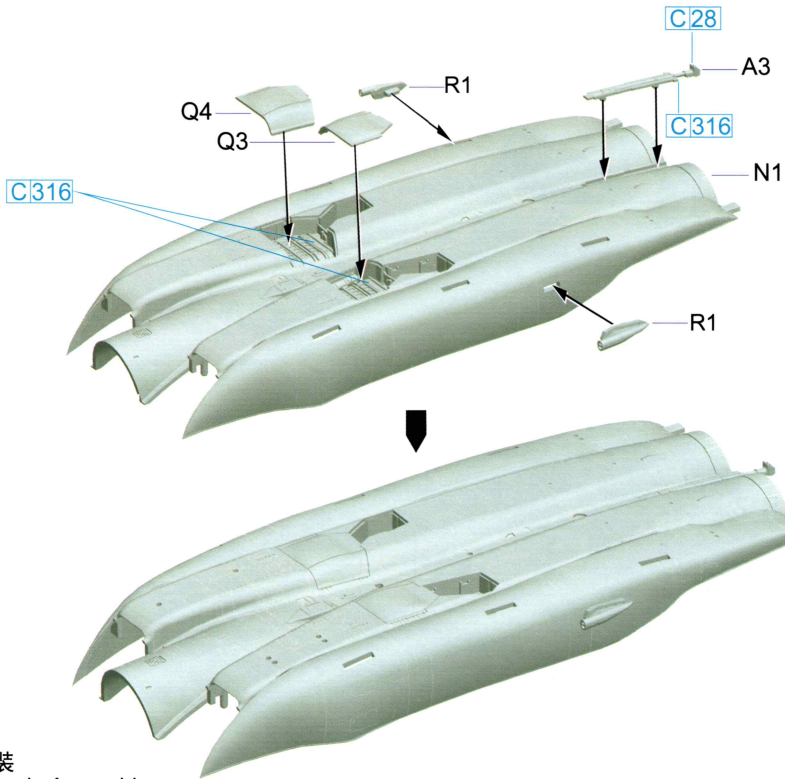

尾噴口組立
Exhaust Nozzle Assemble
ノズル組み立て

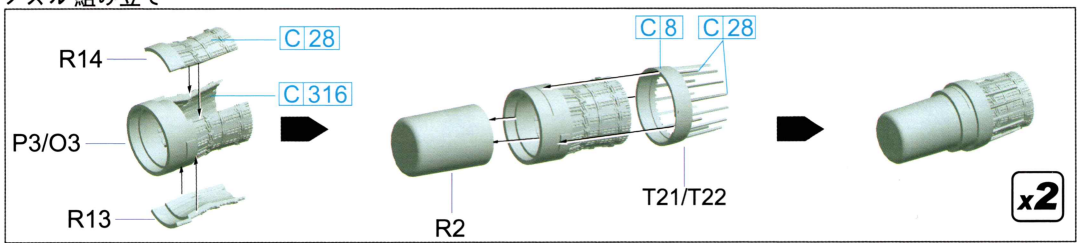

5

起飞降落状态組立
Gear Up Style Assemble
離陸状態組み立て

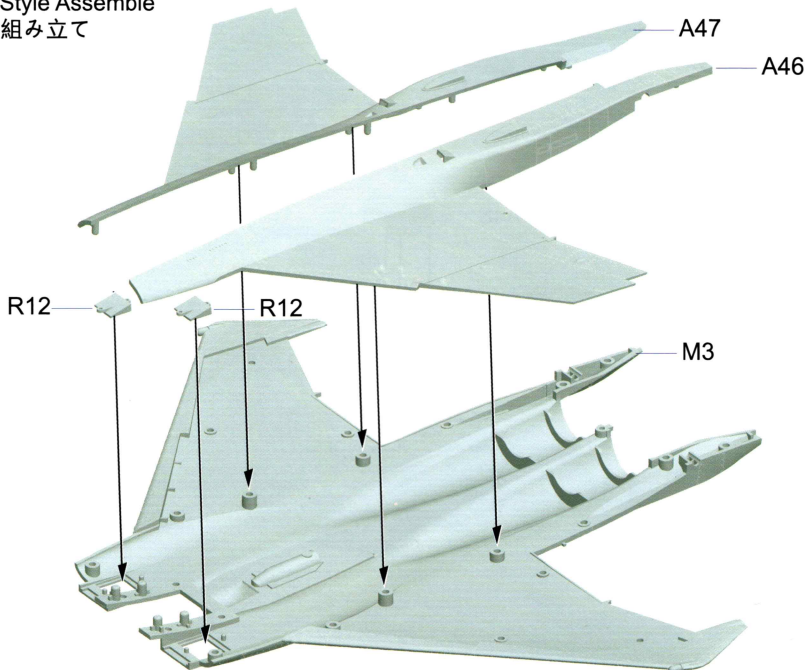

5

起飞降落状态组装
Gear Up Style Assemble
離陸状態組み立て

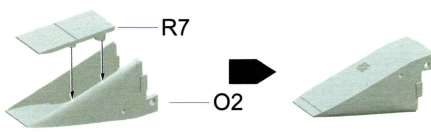

Left

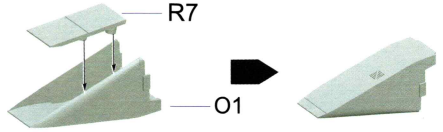

Right

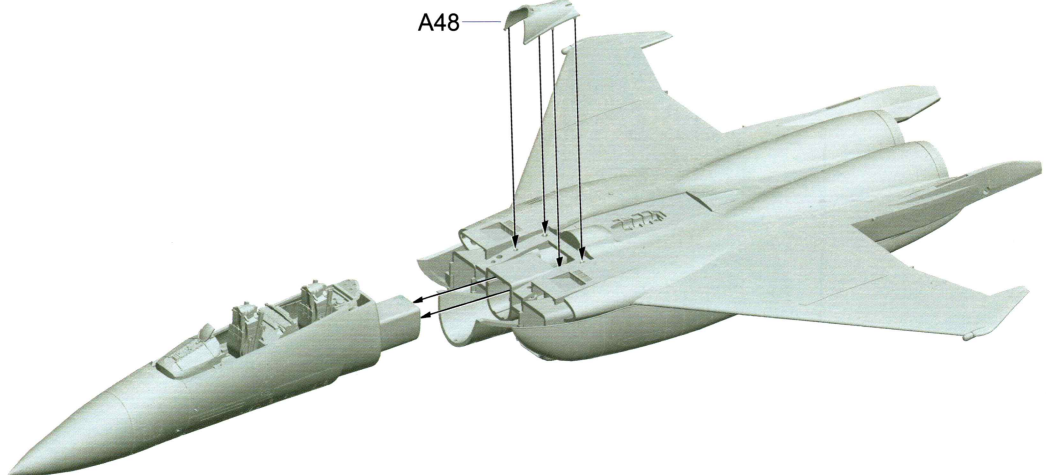
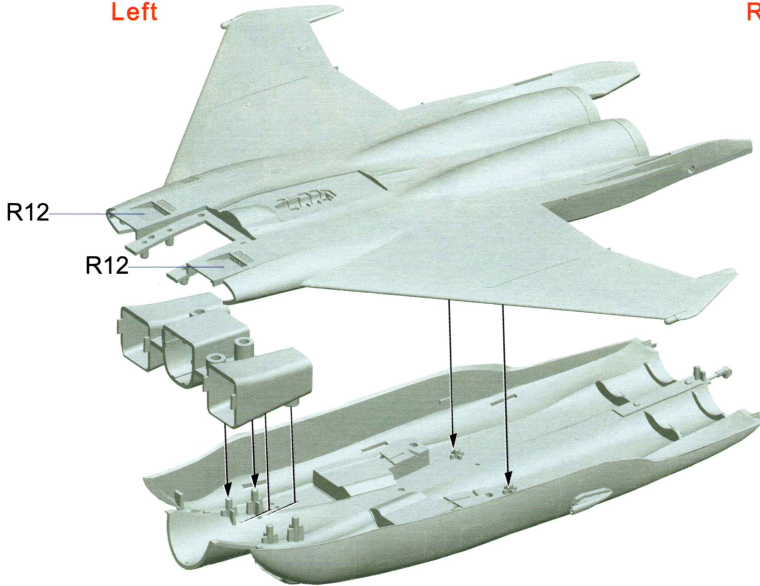

5

起飞降落状态组装
Gear Up Style Assemble
離陸状態組み立て



6

停机状态组装
Gear Down Style Assemble
停止状態の組み立て

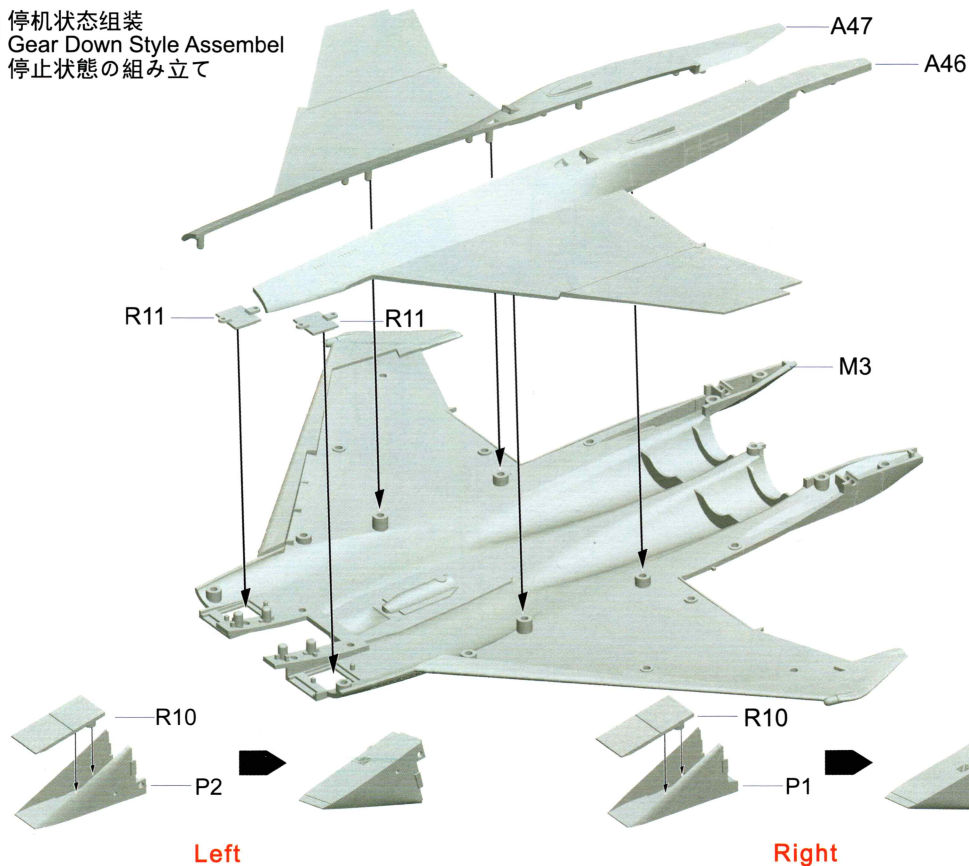

6

停机状态组装
Gear Down Style Assembl
停止状態の組み立て

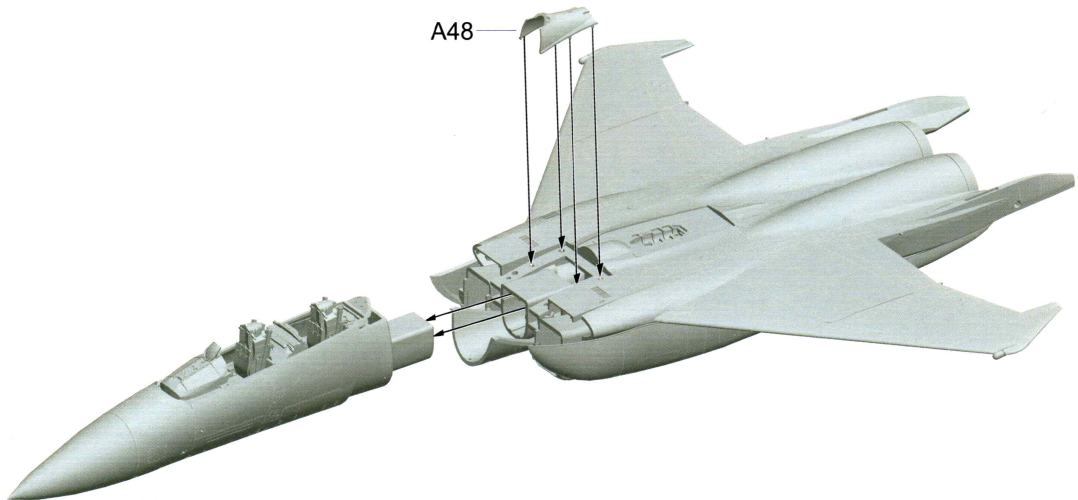
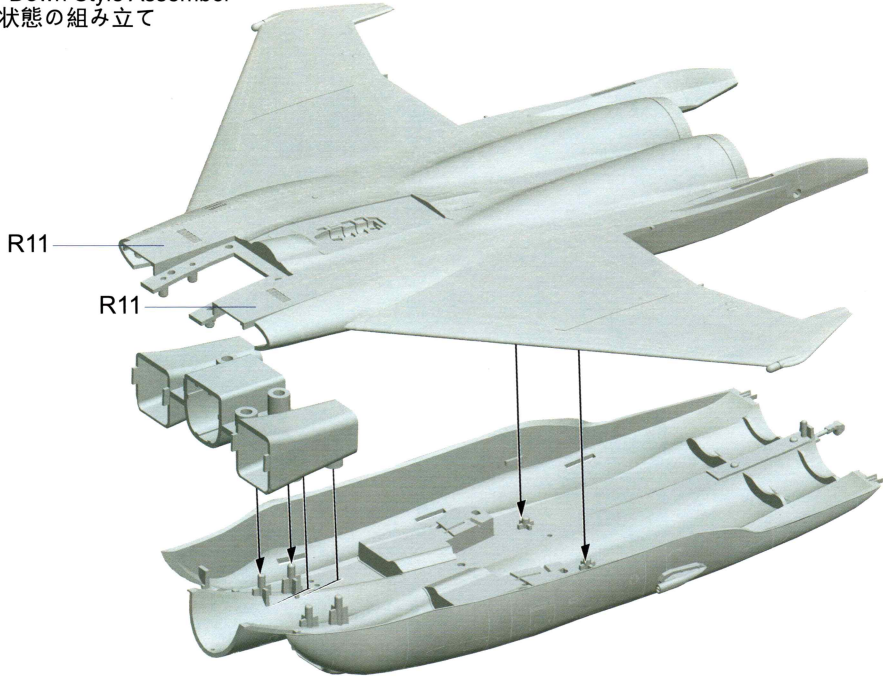

6

停机状态组装
Gear Down Style Assembl
停止状態の組み立て

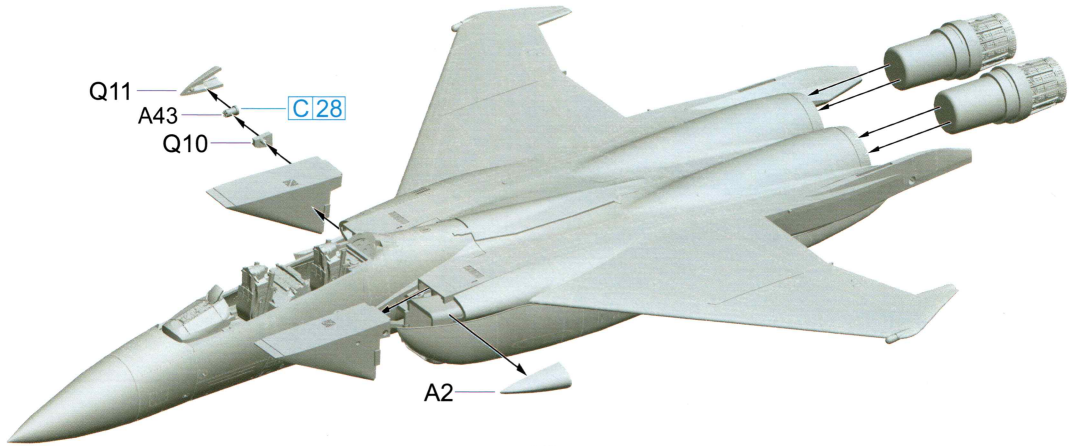

7

关闭状态
Retracted
開け状態

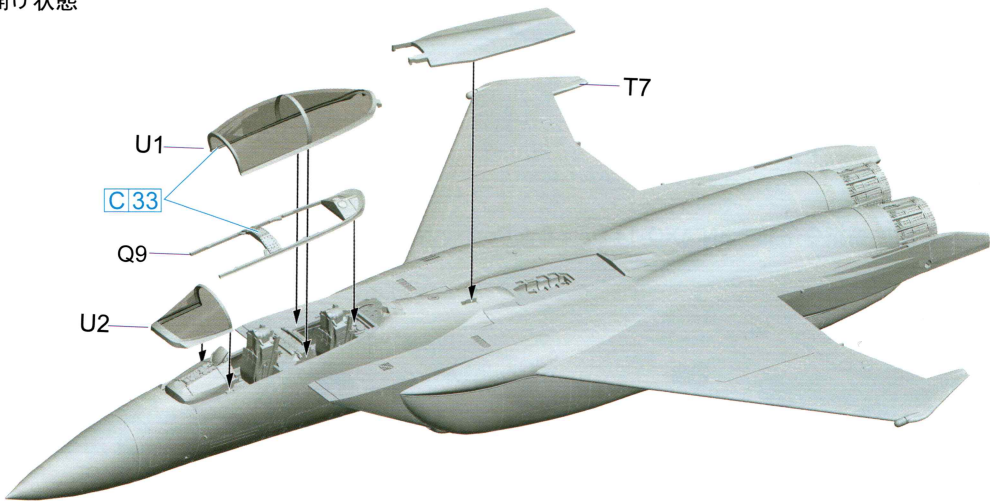

7

关闭状态
Retracted
開け状態



8

打开状态
Extended
開け状態

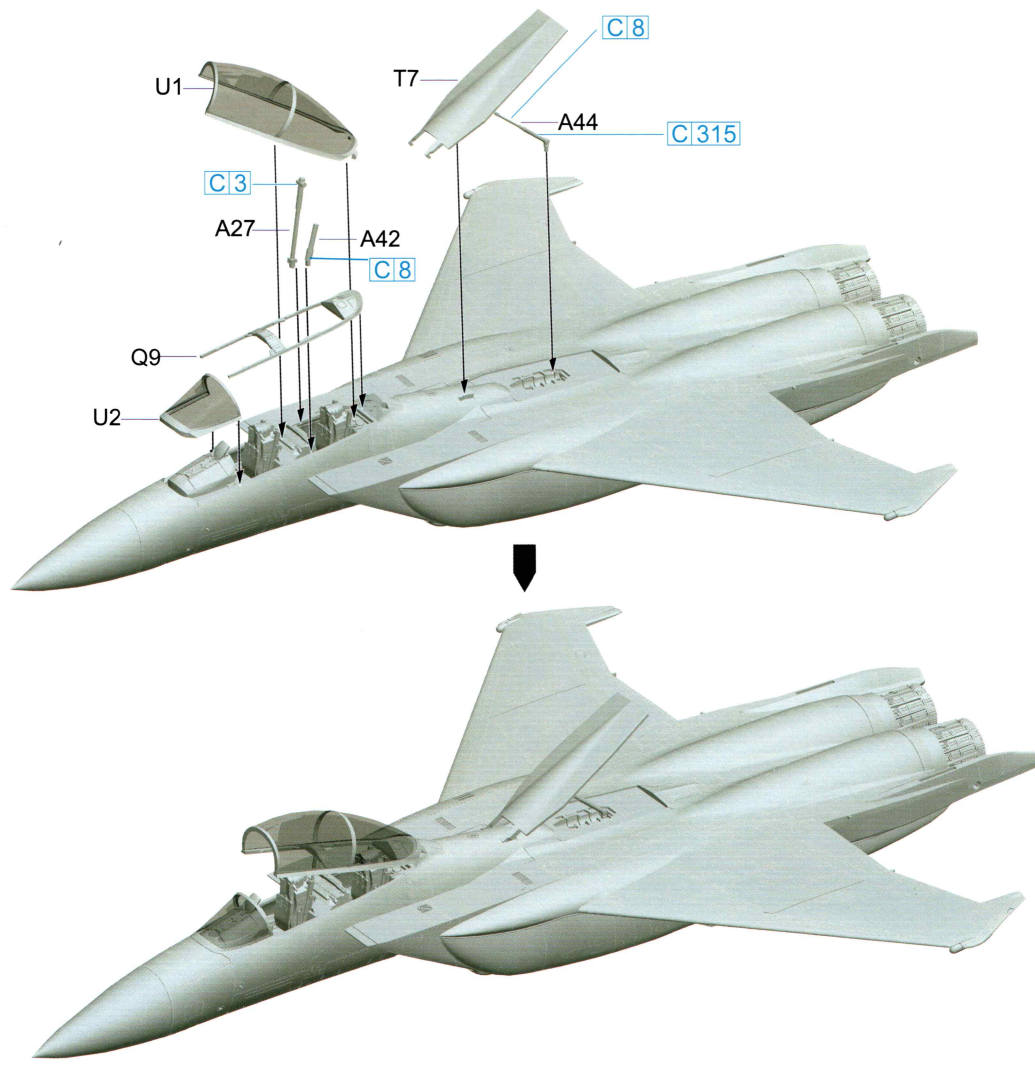

9

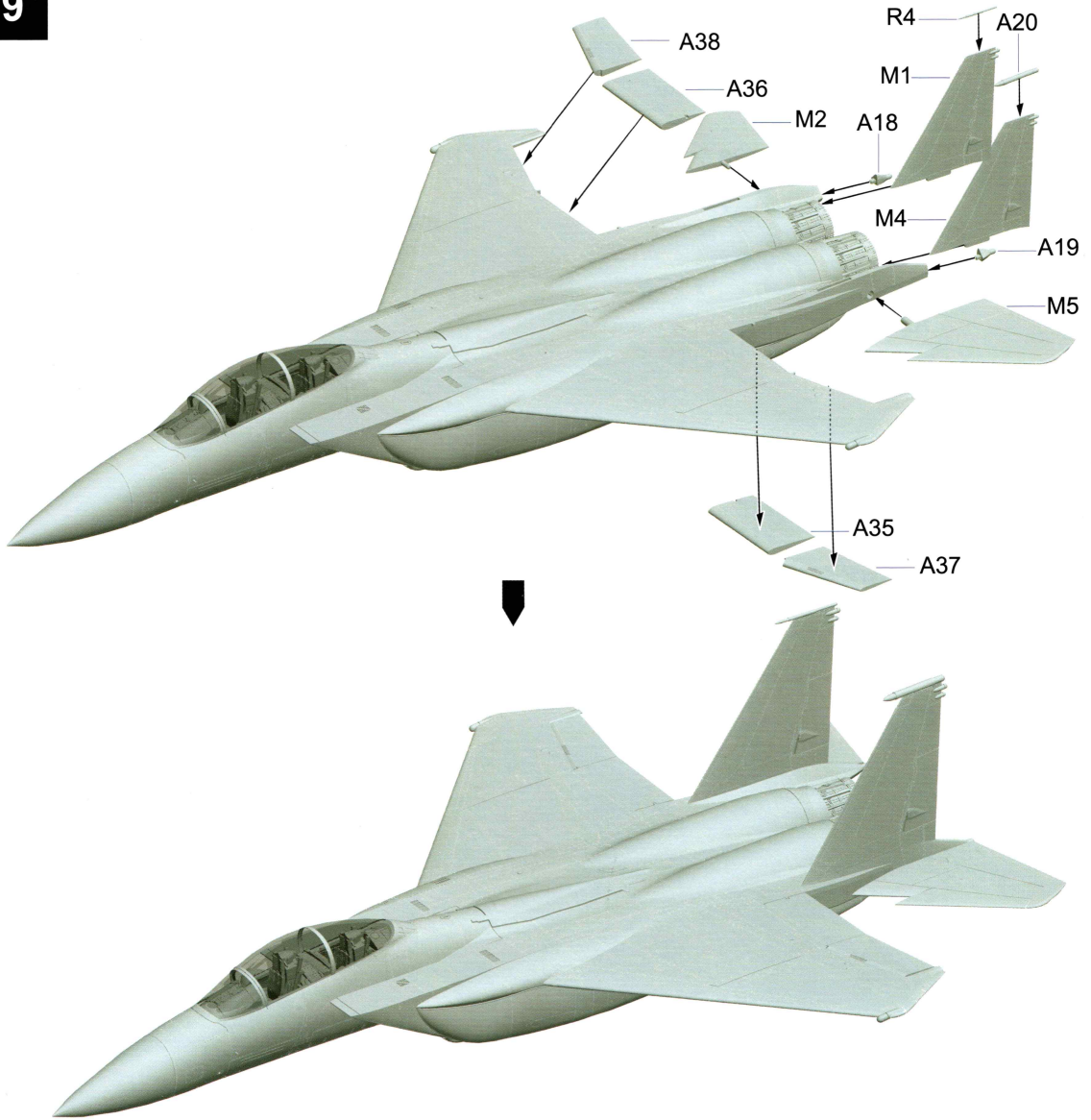

10

前轮
Nose Wheel
前輪

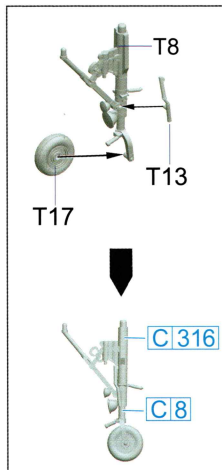

左后轮
Left Main Wheel
左の後輪

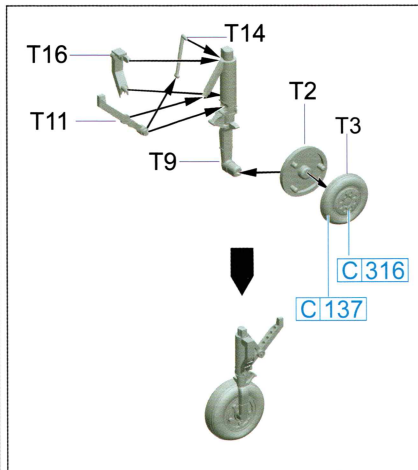

右后轮
Right Main Wheel
右の後輪

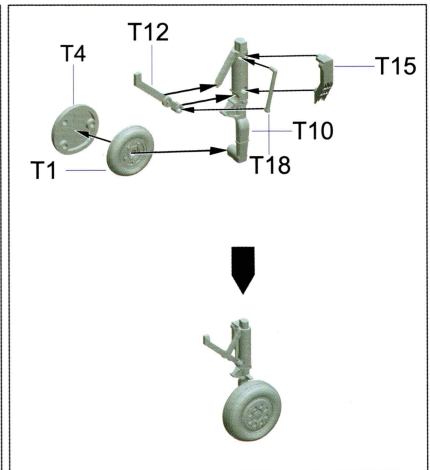

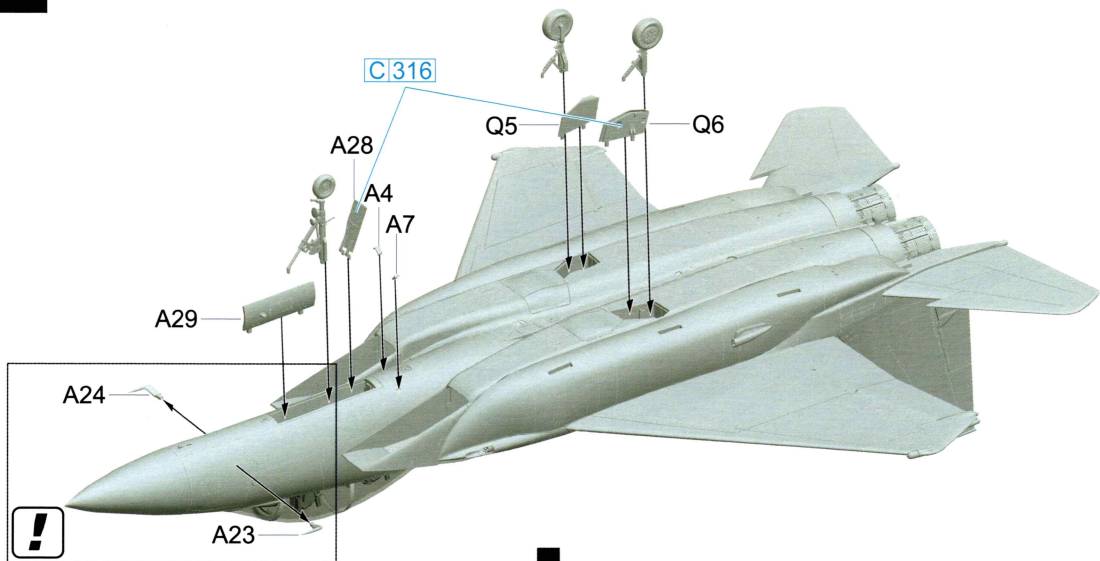

此处先贴相关水贴，然后安装A23,A24零件。
 Apply relevant decals before install part A23 and A24.
 ここですまずデカールを貼って、それから
 インストールA23、A24部品。

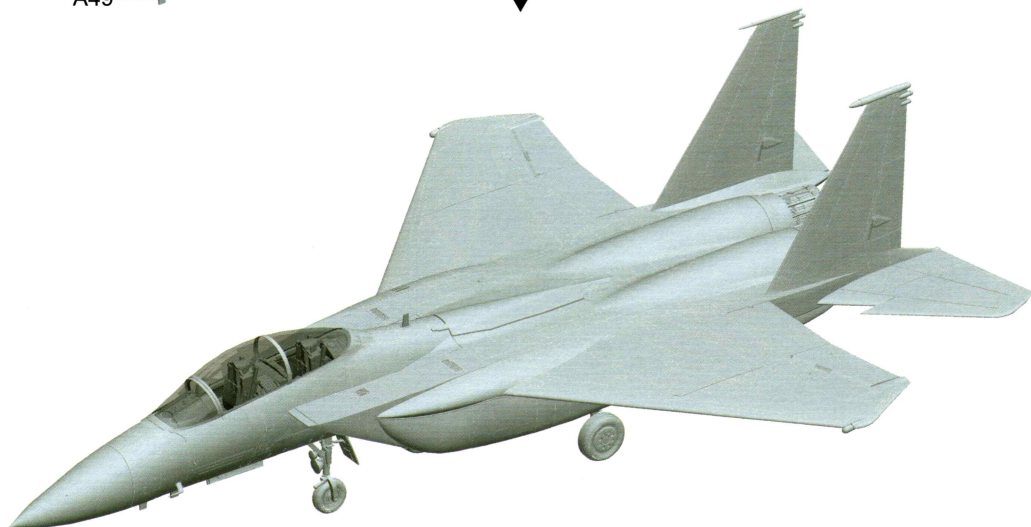
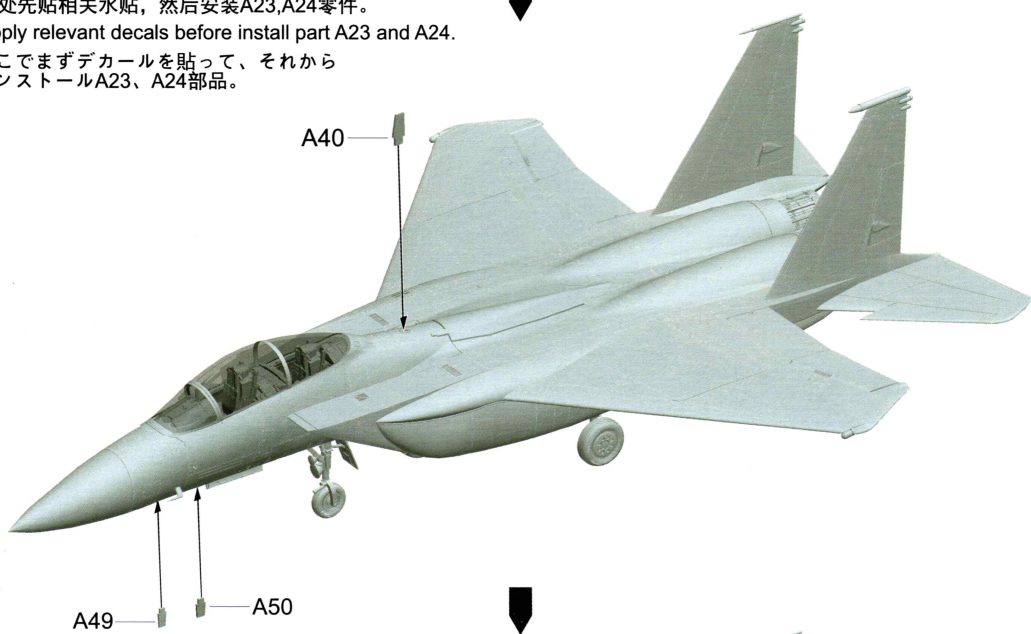

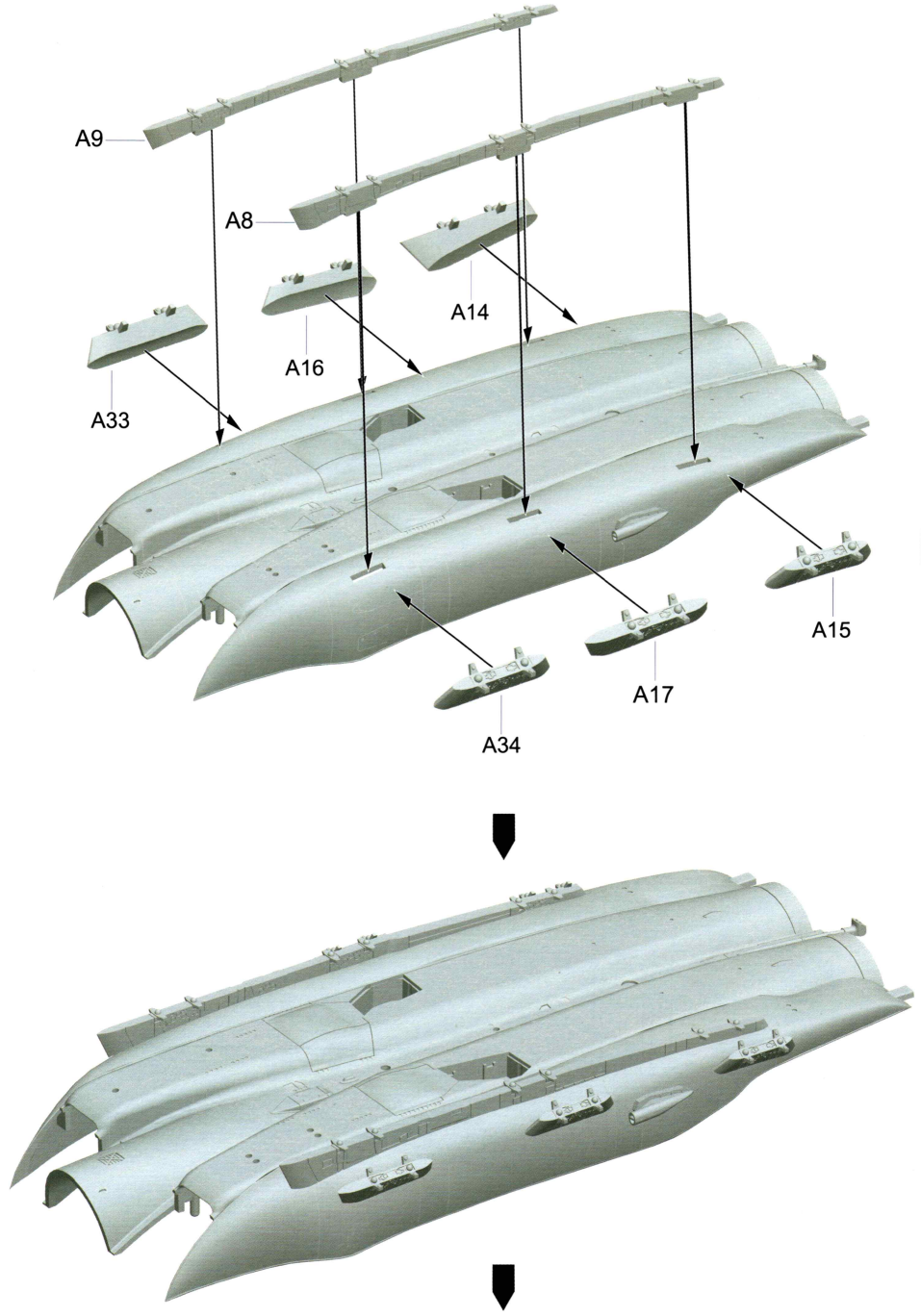

12

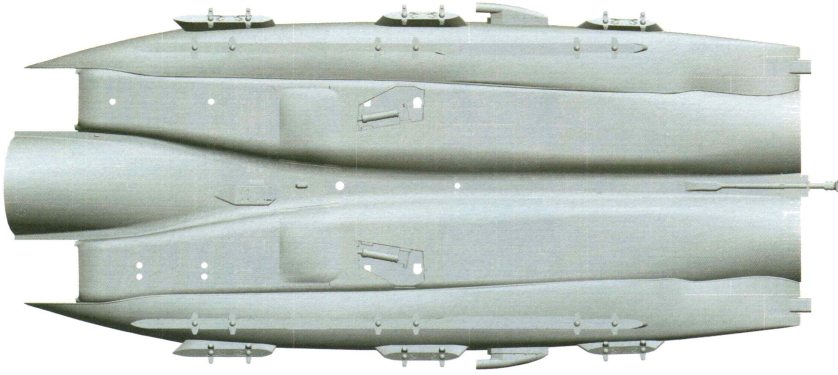

13

AIM-120B 先进中距空空导弹 · AIM-120 AMRAAM

X2

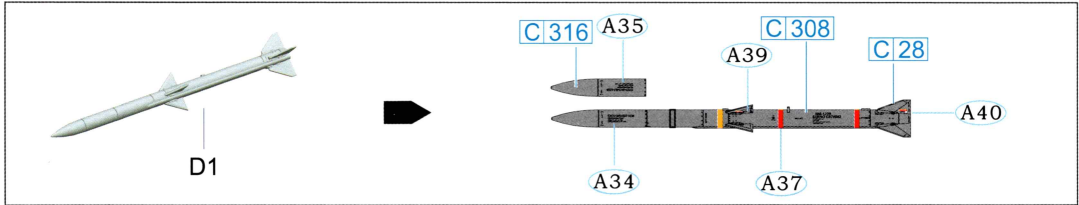

AIM-9L 响尾蛇格斗导弹 · AIM-9L "Sidewinder" Short Range Air-to-Air Missile · AIM-9L サイドワインダー X2

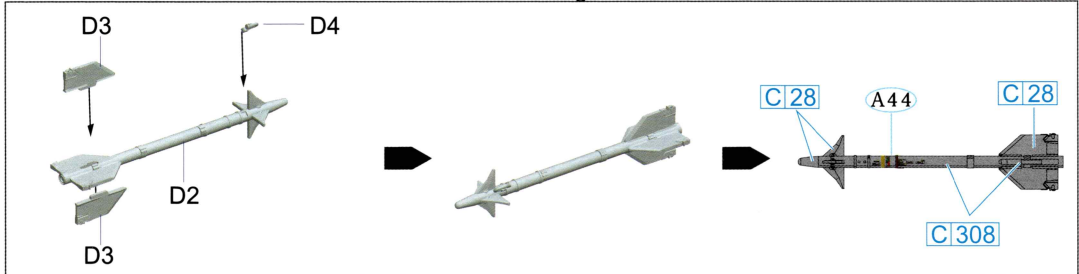

GBU-24 激光制导炸弹 · GBU-24 Laser Guided Bomb · GBU-24 ペイブウェイIII 誘導爆弾

X1

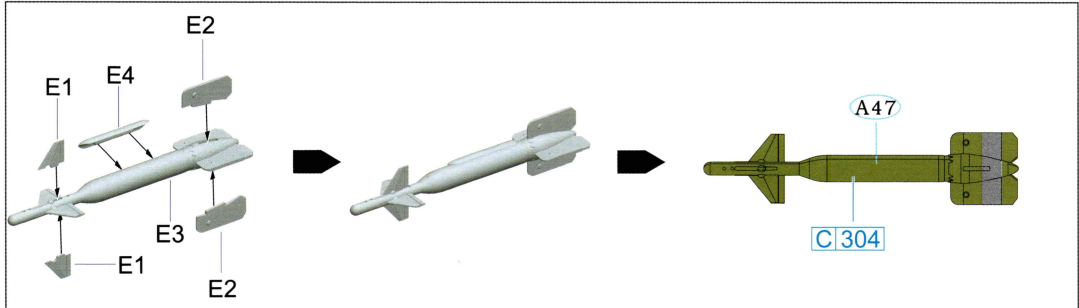

AN/AXQ-14 数据指令吊舱 · AN/AXQ-14 Data-link Pod · AN/AXQ-14 データリンクポッド

X1

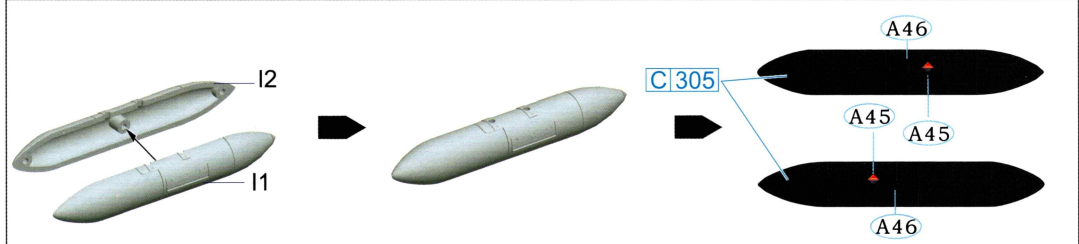

AN/AAQ-14目标指示吊舱 · AN/AAQ-14 Targeting Pod · AN/AAQ-14照準ポッド

X1

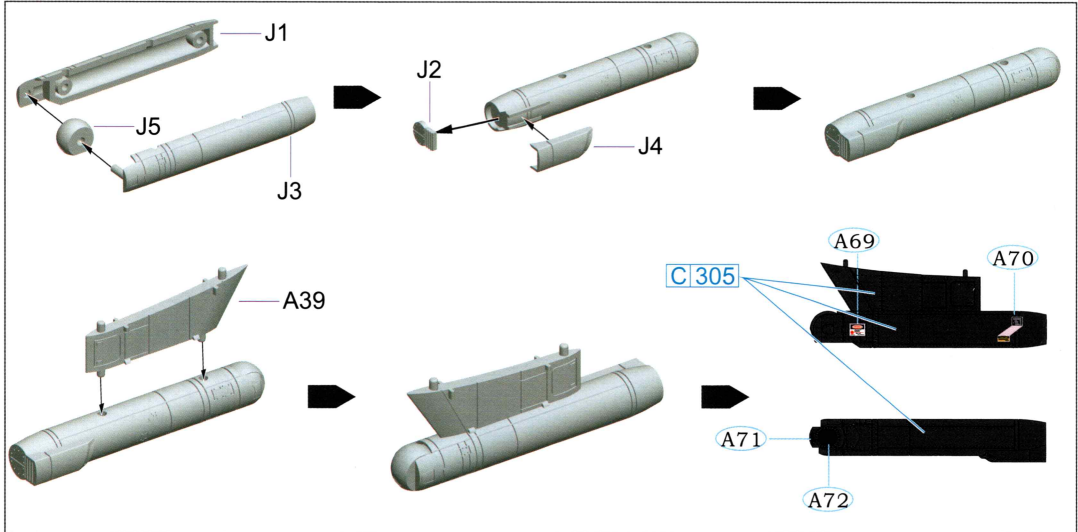

AN/AAQ-13低空导航吊舱 · AN/AAQ-13 Navigation Pod · AN/AAQ-13航法ポッド

X1

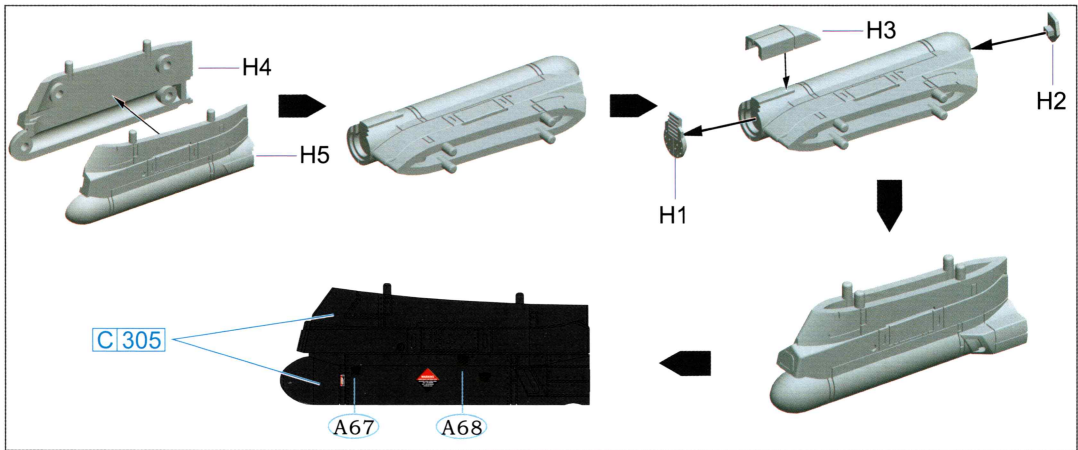

GBU-15电视制导炸弹 · GBU-15 TV-Guided Bomb · GBU-15誘導爆弾

X1

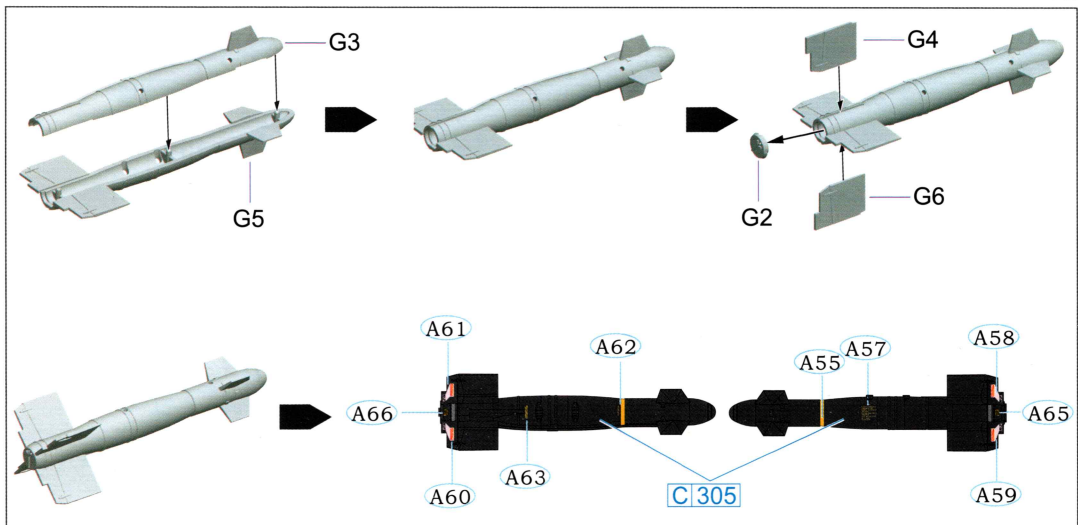

13

610副油箱・610Drop Tank・610ガロン増槽

X2

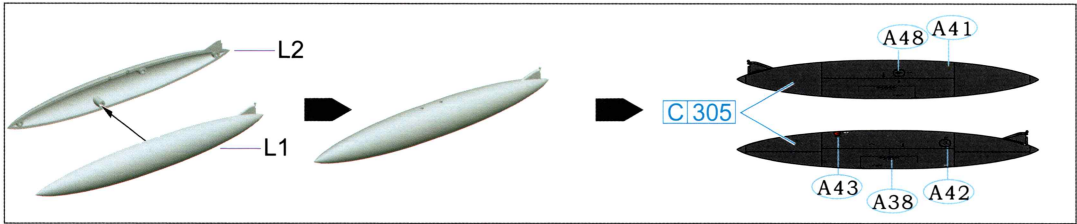

GBU-12激光制导炸弹・GBU-12 Laser Guided Bomb・GBU-12 ペイブウェイII誘導爆弾

X3

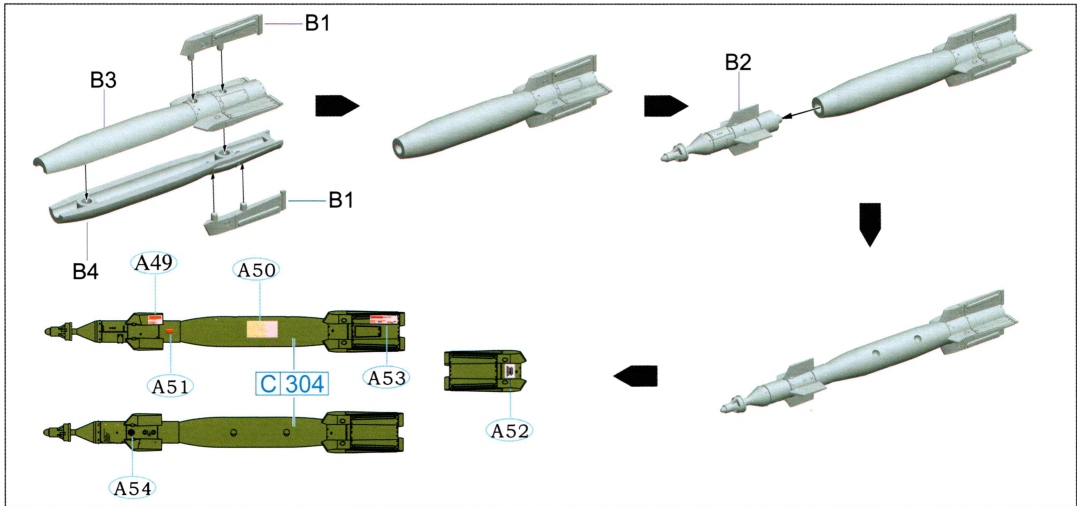

14

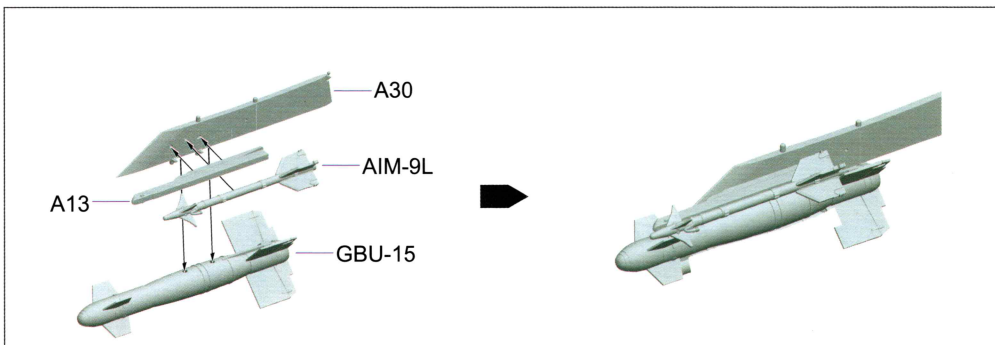
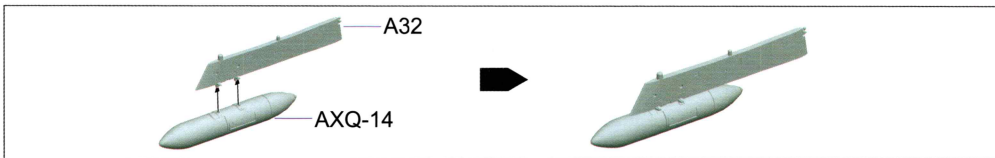
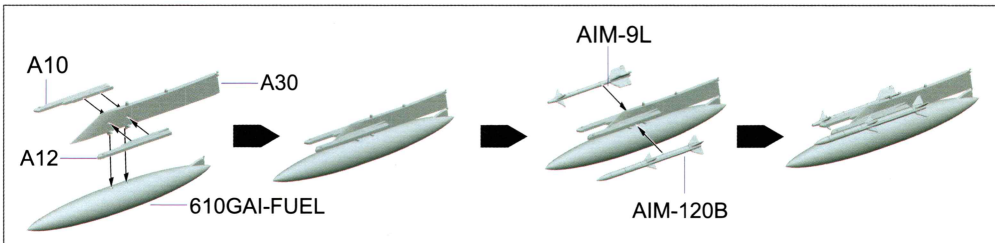

F-15E “攻击鹰” 87-0173号机 “鲨鱼嘴” 美国空军366联队391中队（“勇虎”中队）美国爱达荷州芒廷霍姆基地 (MO)2002年；

F-15E Strike Eagle 87-0173 'Shark Mouth', 391st Fighter Squadron 'Bold Tigers', 366th Fighter Wing, U.S.A.F Mountain Home AFB, Idaho, 2002

第336戦闘航空団第391戦闘飛行隊 MO:87-0173号機 2002年アイダホ

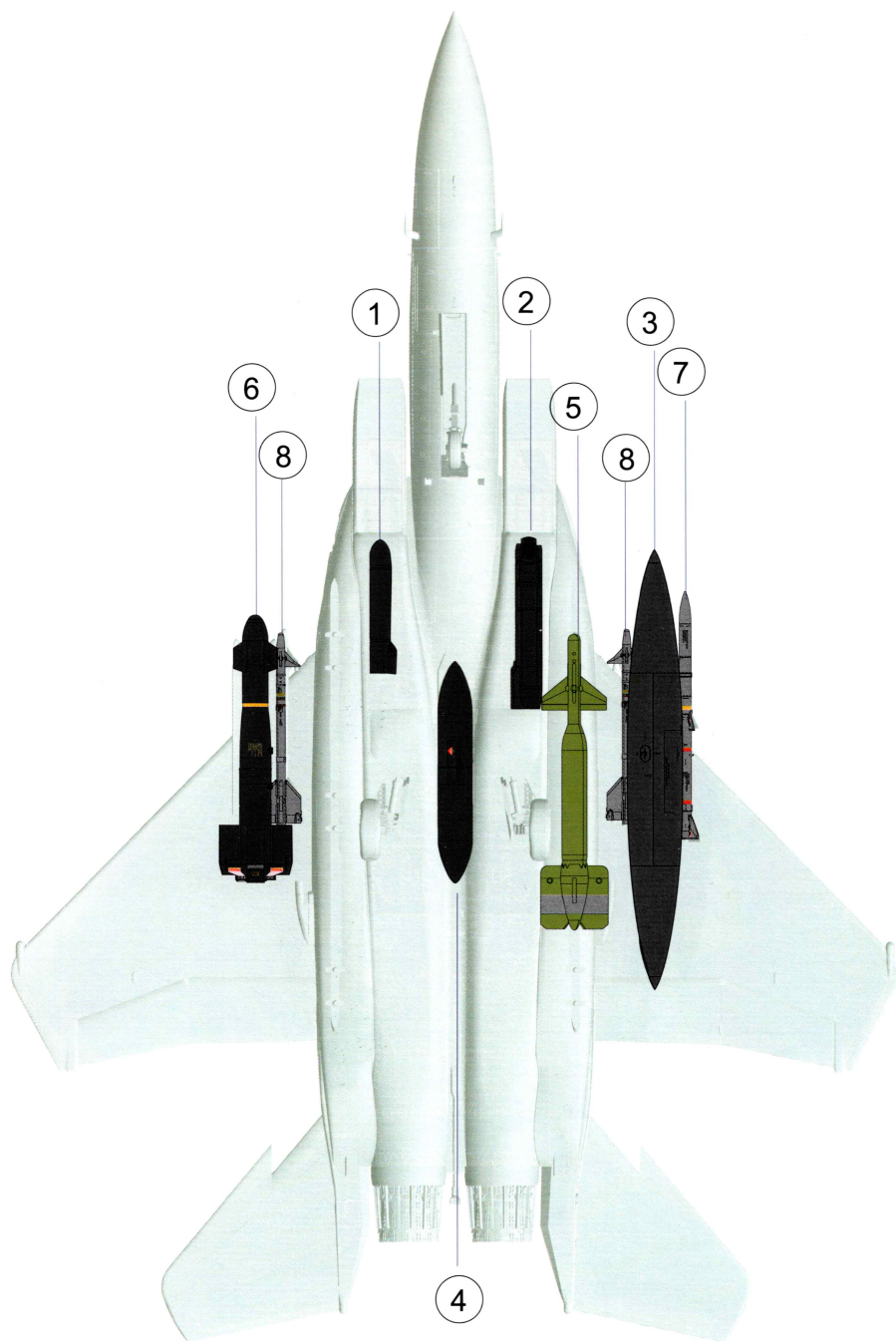

- | | | | |
|-------------|-------------|------------------|-------------|
| ① AAQ-13 X1 | ② AAQ-14 X1 | ③ 610GAI-FUEL X1 | ④ AXQ-14 X1 |
| ⑤ GBU-24 X1 | ⑥ GBU-15 X1 | ⑦ AIM-120B X1 | ⑧ AIM-9L X2 |

F-15E “攻击鹰” 87-0169号机“911纪念涂装--虎头” 美国空军366联队391中队 (“勇虎”中队) 美国爱达荷州芒廷霍姆基地(MO)2002年;

F-15E Strike Eagle 87-0169 'Tiger Lead', 391st Fighter Squadron 'Bold Tigers', 366th Fighter Wing, U.S.A.F Mountain Home AFB, Idaho, 2002

第336戦闘航空団第391戦闘飛行隊 MO:87-0169号機 2002年アイダホ

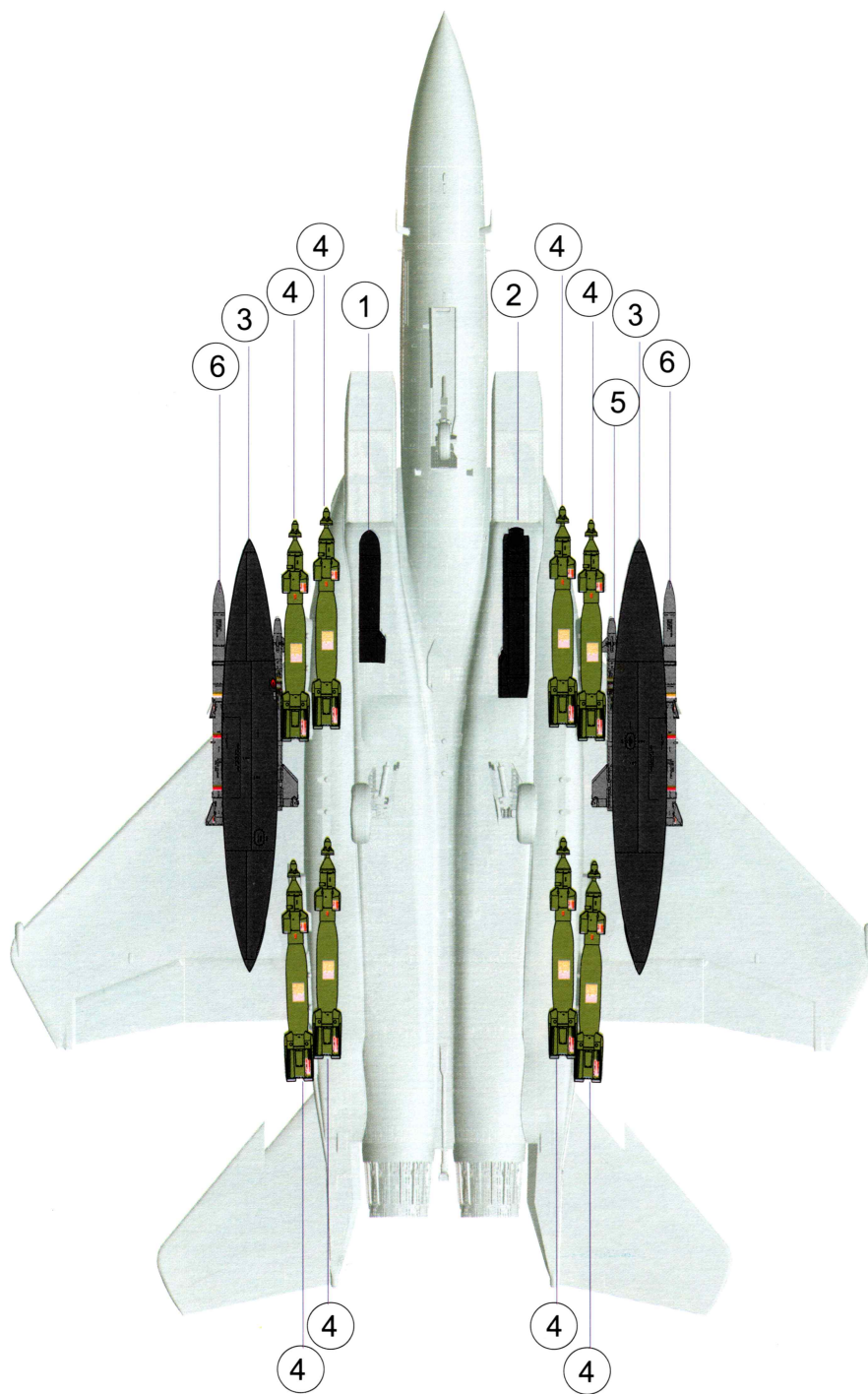

- ① AAQ-13 X1 ② AAQ-14 X1 ③ 610GAI-FUEL X2 ④ GBU-12 X8
- ⑤ AIM-9L X2 ⑥ AIM-120B X2

F-15E-47-MC “攻击鹰”89-0488号机“火箭快递”，垂尾代码“SJ”，美国空军第4联队336中队（“火箭人”中队），卡塔尔 阿尔·乌代德空军基地，2003年

F-15E-47-MC Strike Eagle ‘Rocket Express’ 89-0488 SJ 336th FS ‘Rocketeers’, 4thTFW , U.S.A.F, Al Udeid AB , Qatar 2003

第4戦闘航空団第336戦闘飛行隊 SJ:89-0488号機 2003年カタール

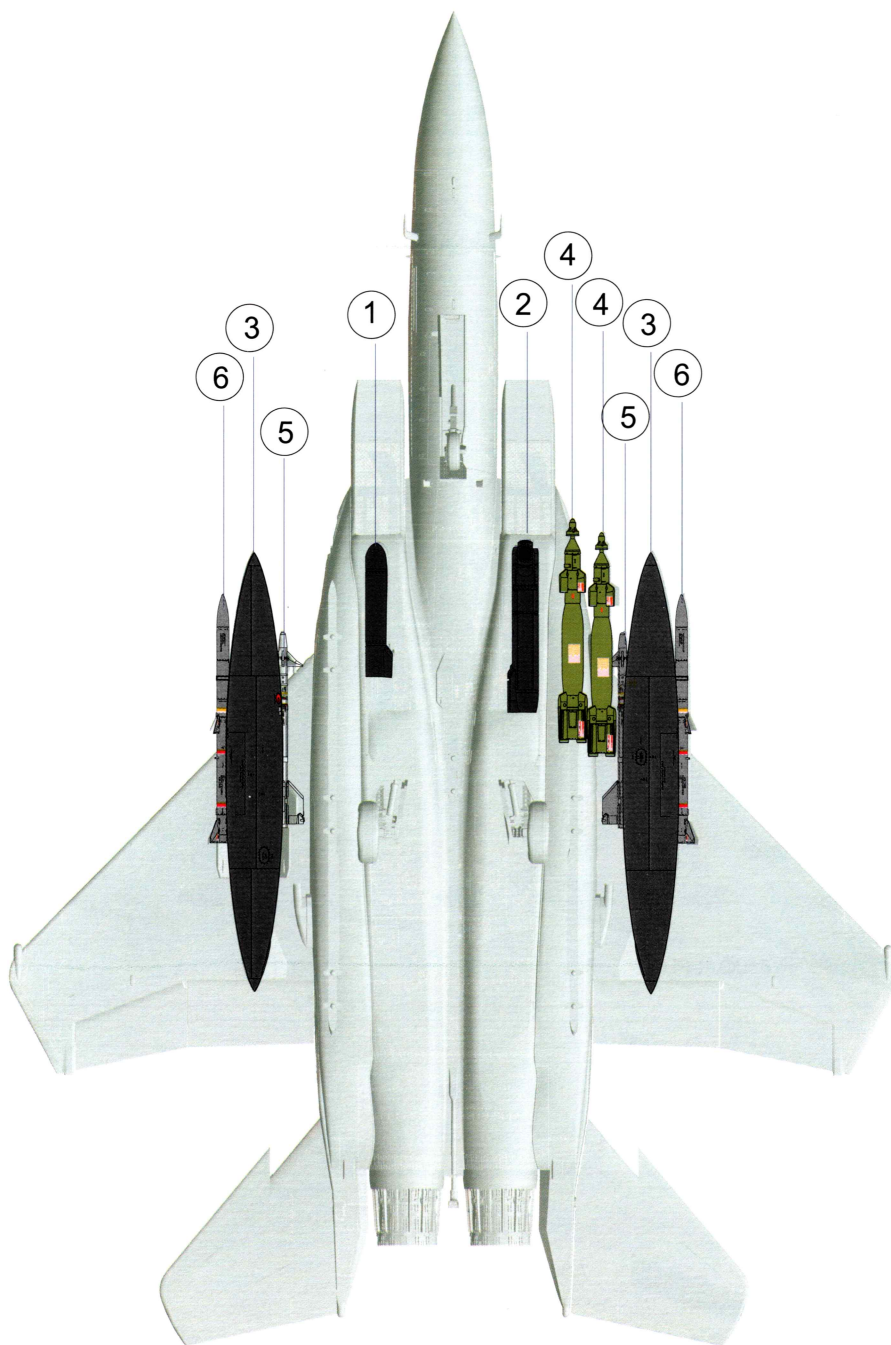

- ① AAQ-13 X1 ② AAQ-14 X1 ③ 610GAI-FUEL X2 ④ GBU-12 X2
⑤ AIM-9L X2 ⑥ AIM-120B X2

通用水贴涂装指示（侧面）

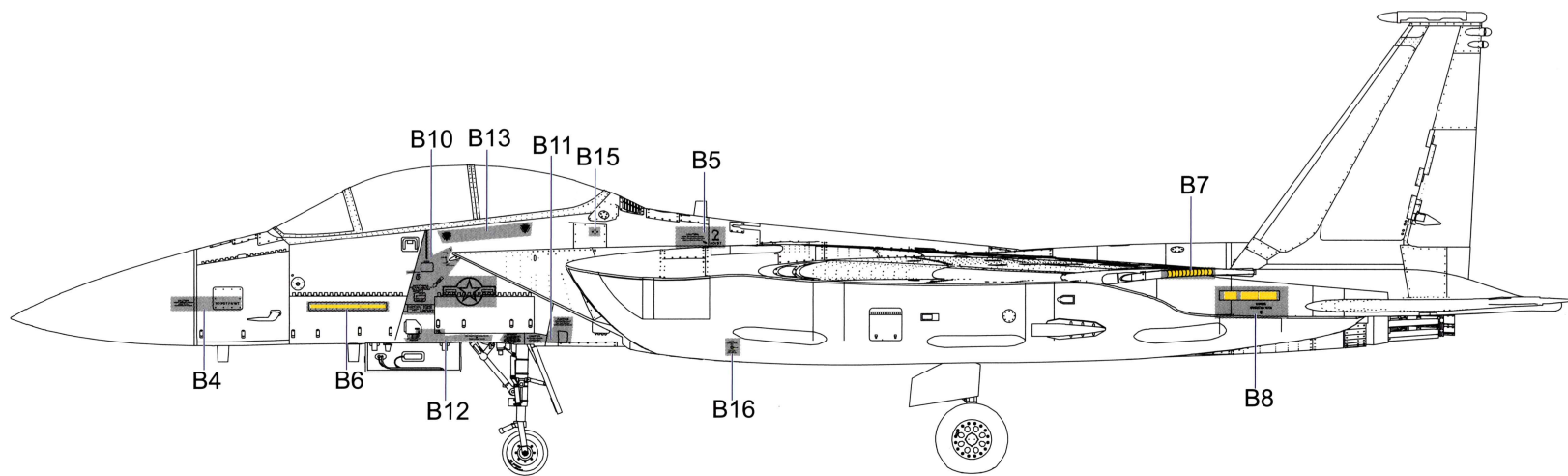
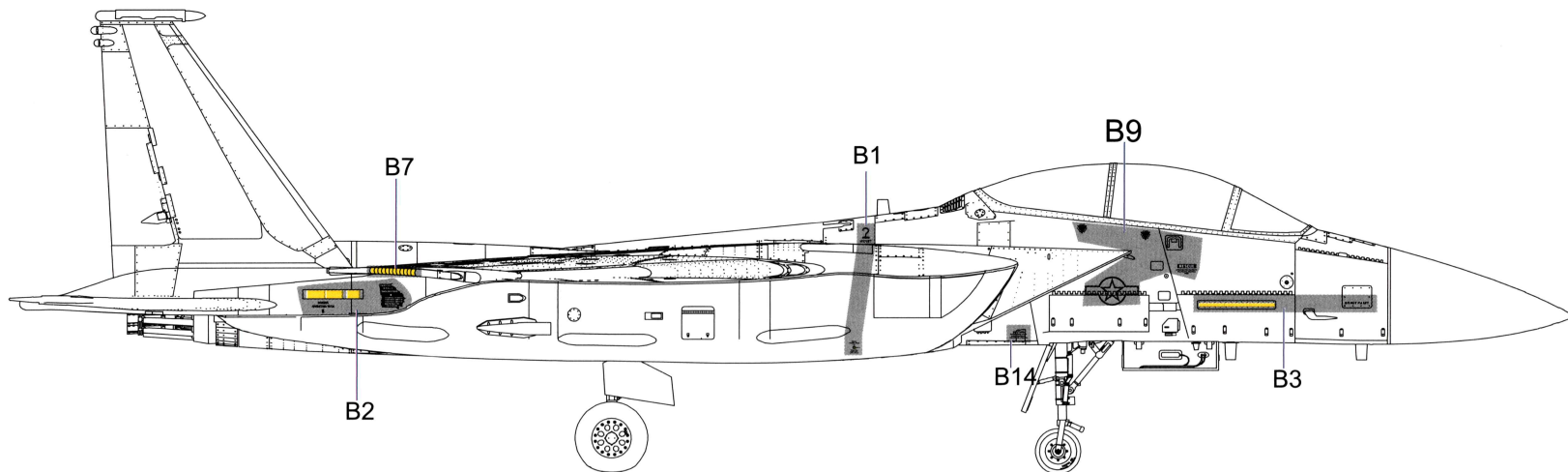

0173: F-15E 87-0173号机 “鲨鱼嘴” 美国空军366联队391中队 (“勇虎”中队) 美国爱达荷州芒廷霍姆基地 (MO) 2002年
 F-15E 87-0173 'Shark Mouth', 391st Fighter Squadron 'Bold Tigers', 366th Fighter Wing, U.S.A.F Mountain Home AFB, Idaho, 2002

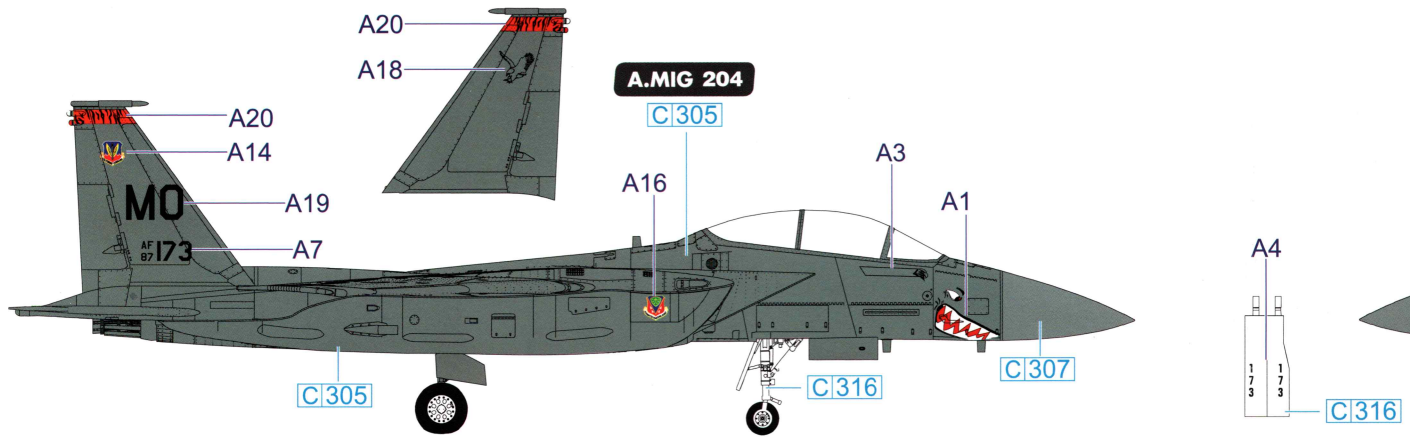

0169: F-15E 87-0169号机 “911纪念涂装—虎头” 美国空军366联队391中队 (“勇虎”中队) 美国爱达荷州芒廷霍姆基地 (MO) 2002年
 F-15E 87-0169 'Tiger Lead', 391st Fighter Squadron 'Bold Tigers', 366th Fighter Wing, U.S.A.F Mountain Home AFB, Idaho, 2002

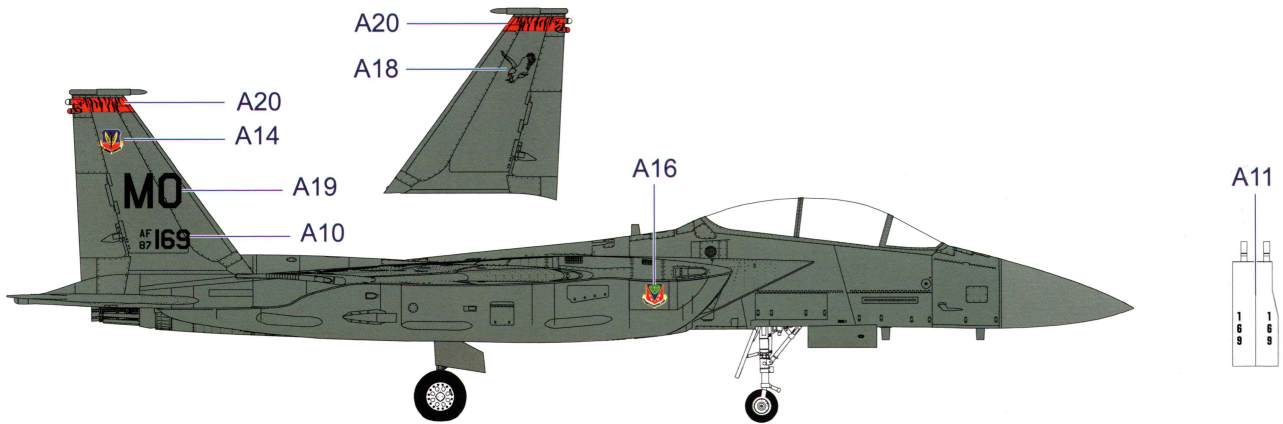

0488: F-15E-47-MC 89-0488号机 美国空军第4联队336中队 (“火箭人”中队) 卡塔尔 阿尔·乌代德空军基地, 2003年
 F-15E-47-MC 89-0488 336th FS 'Rocketeers', 4th TFW, U.S.A.F, Al Udeid AB, Qatar 2003

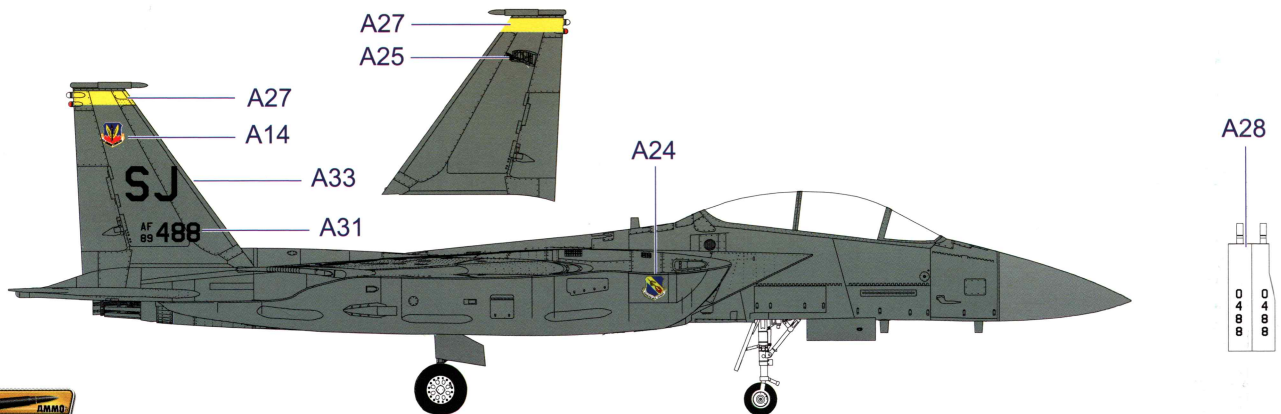

Color info and profiles by

Painting and Marking Guide

MIG 205 Gray

MIG 047 Satin White

MIG 046 Matt Black

A.MIG 204 Medium Gunship Gray

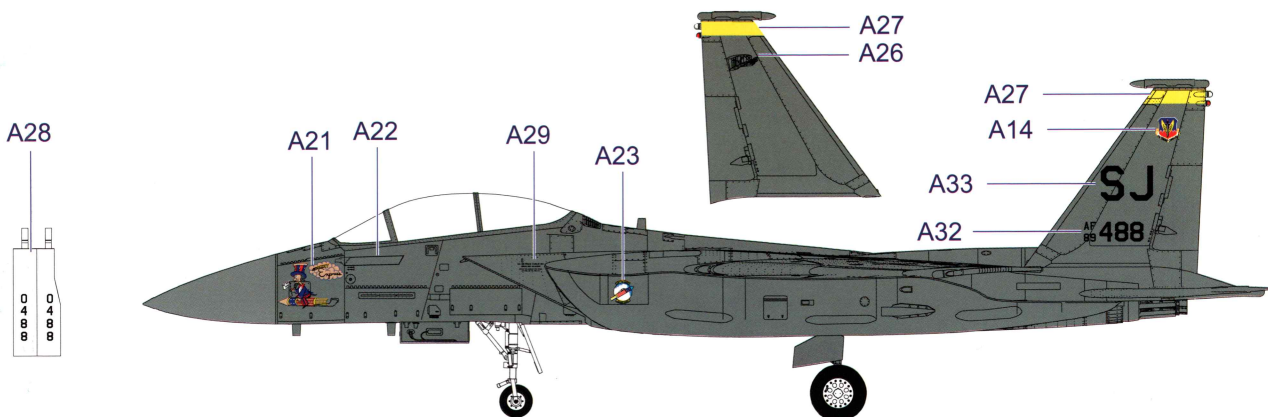
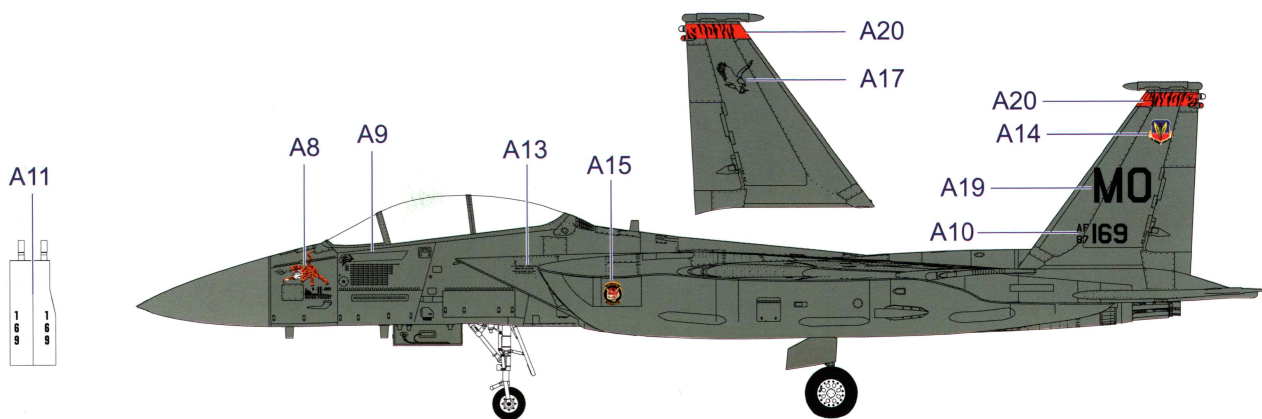
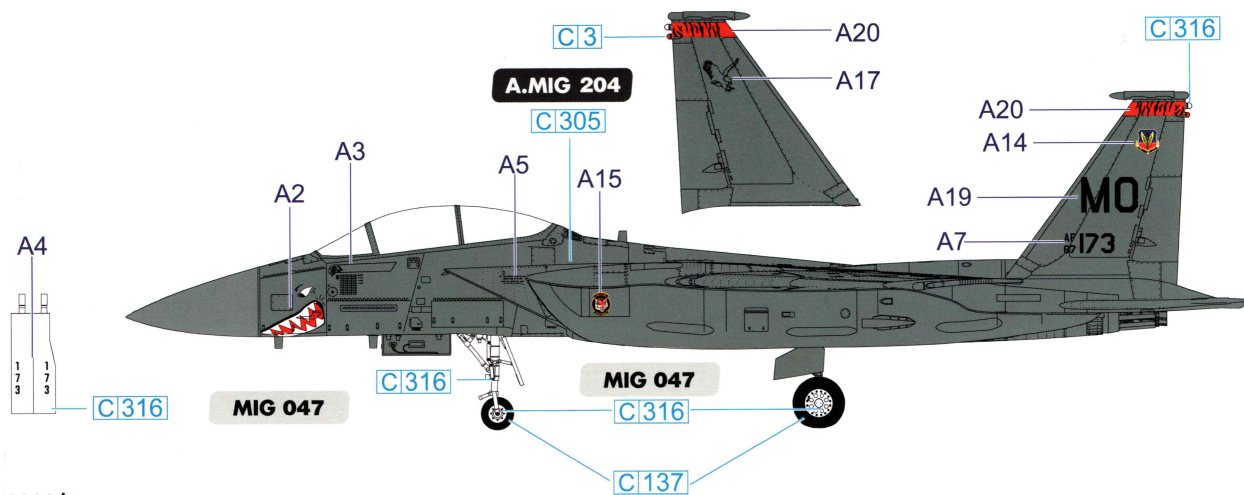

- 0173: F-15E 87-0173号机 “鲨鱼嘴” 美国空军366联队391中队 (“勇虎” 中队) 美国爱达荷州芒廷霍姆基地 (MO) 2002年
 F-15E 87-0173 'Shark Mouth', 391st Fighter Squadron 'Bold Tigers', 366th Fighter Wing, U.S.A.F Mountain Home AFB, Idaho, 2002
- 0169: F-15E 87-0169号机 “911纪念涂装—虎头” 美国空军366联队391中队 (“勇虎” 中队) 美国爱达荷州芒廷霍姆基地 (MO) 2002年
 F-15E 87-0169 'Tiger Lead', 391st Fighter Squadron 'Bold Tigers', 366th Fighter Wing, U.S.A.F Mountain Home AFB, Idaho, 2002
- 0488: F-15E-47-MC 89-0488号机 美国空军第4联队336中队 (“火箭人” 中队) 卡塔尔 阿尔·乌代德空军基地, 2003年
 F-15E-47-MC 89-0488 336th FS 'Rocketeers', 4th TFW, U.S.A.F, Al Udeid AB, Qatar 2003

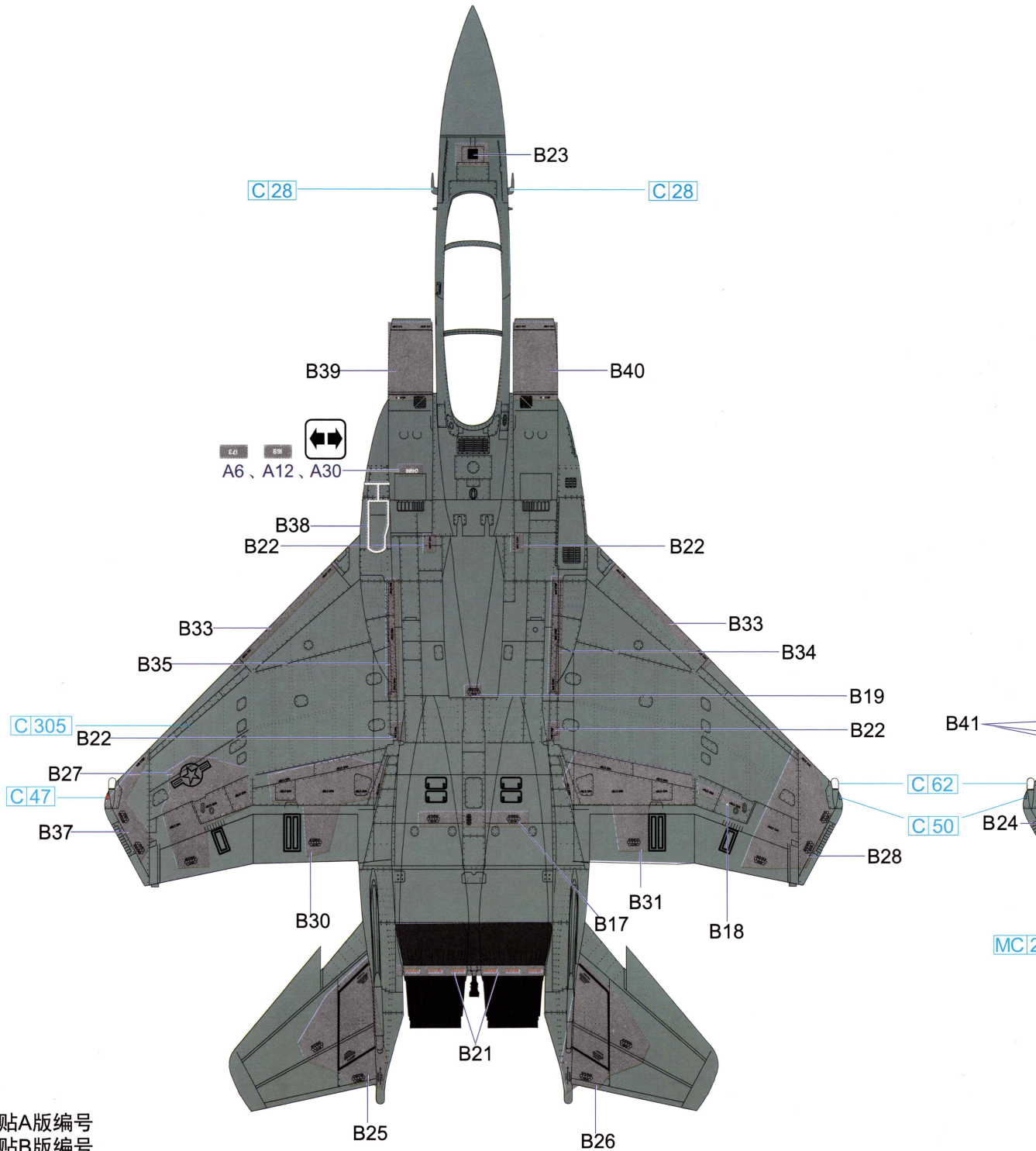

- A00 : 水贴A版编号
 B00 : 水贴B版编号
 C00 : 油漆编号

2002年
Home AFB, Idaho, 2002



母基地 (MO) 2002年
Home AFB, Idaho, 2002

003年

