

# GERMAN HALF TRACK HANOMAG SD.KZF. 251/10 KIT 8053



1/72 SCALE

1/72 EME

## DONNÉES TECHNIQUES CONCERNANT LE VTT SD.KFZ. 251/10

**CONSTRUCTEUR:** Hanomag  
**POIDS EN ORDRE  
DE COMBAT:** 8.9 tons  
**LONGUEUR:** 5.80 m  
**LARGEUR:** 2.10 m  
**HAUTEUR:** 2.10 m  
**TYPE DE MOTEUR:** Maybach  
« hl 42 tukrm »  
**VITESSE:** 33 mph  
**RAYON D'ACTION:** 170 mls  
**EQUIPAGE:** 6  
**ARMEMENT:** 1 canon de 37 mm  
1 mitrailleuse de 7.9 mm

### CANON ANTICHAR 3.7 cm PAK 35

**PORTÉE MAXIMUM:** 600 yds  
**DÉPRESSION:** 25°  
**ÉLÉVATION:** 8°  
**SECTEUR DE TIR:** 60°  
**MUNITIONS:** ap  
**COUPS PAR MINUTE:** 8 - 10

## TECHNICAL DATA FOR THE A.P.C. SD.KFZ. 251/10

**MANUFACTURER:** Hanomag  
**COMBAT WEIGHT:** 8.9 tons  
**LENGTH:** 5.80 m  
**WIDTH:** 2.10 m  
**HEIGHT:** 2.10 m  
**ENGINE:** Maybach « hl 42 tukrm »  
**SPEED:** 33 mph  
**RADIUS OF ACTION:** 170 mls  
**CREW:** 6  
**ARMAMENT:** one 37 mm gun  
one 7.9 mm machine gun

### ANTI-TANK GUN 3.7 cm PAK 35

**MAXIMUM EFF. RANGE:** 600 yds  
**DEPRESSION:** 25°  
**ELEVATION:** 8°  
**TRAVERSE:** 60°  
**AMMUNITIONS:** ap  
**RATE OF FIRE:** 8 - 10

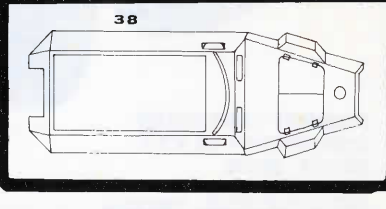
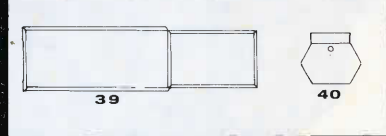
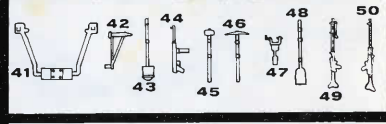
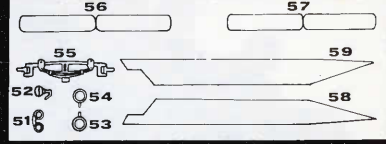
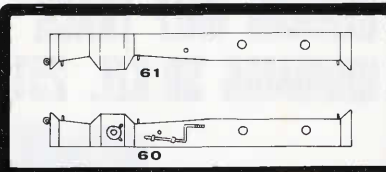
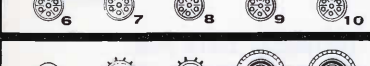
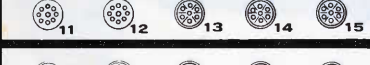
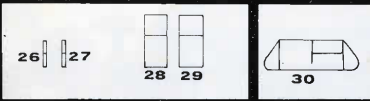
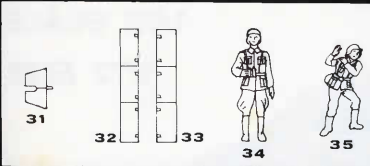
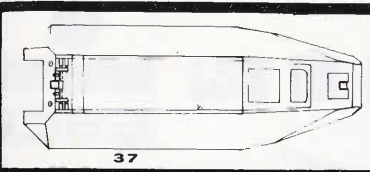

2

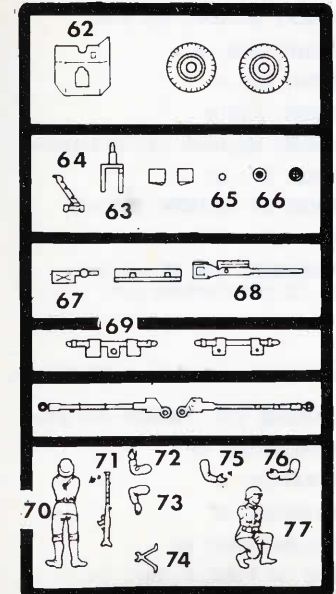
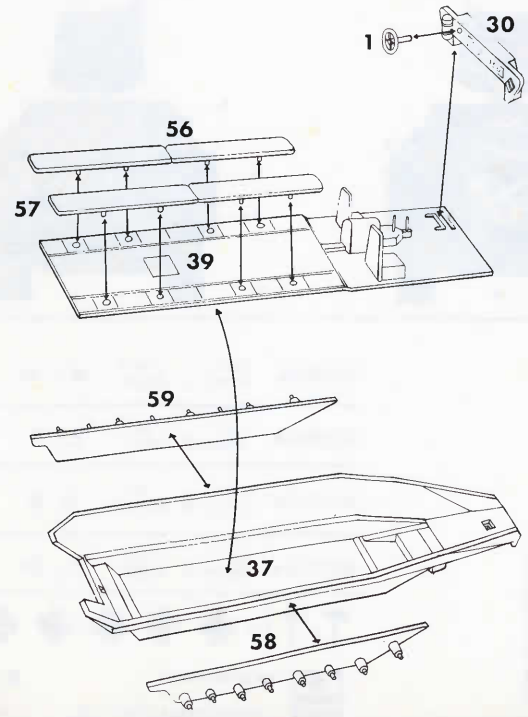
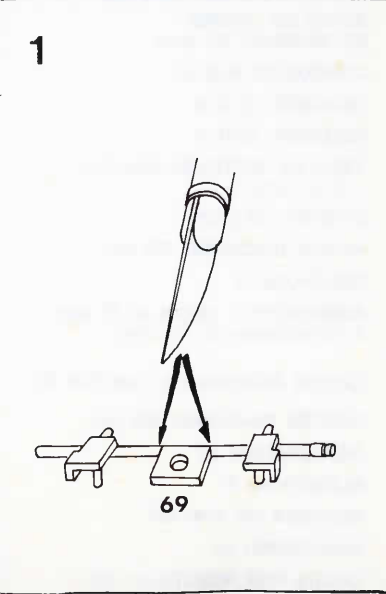
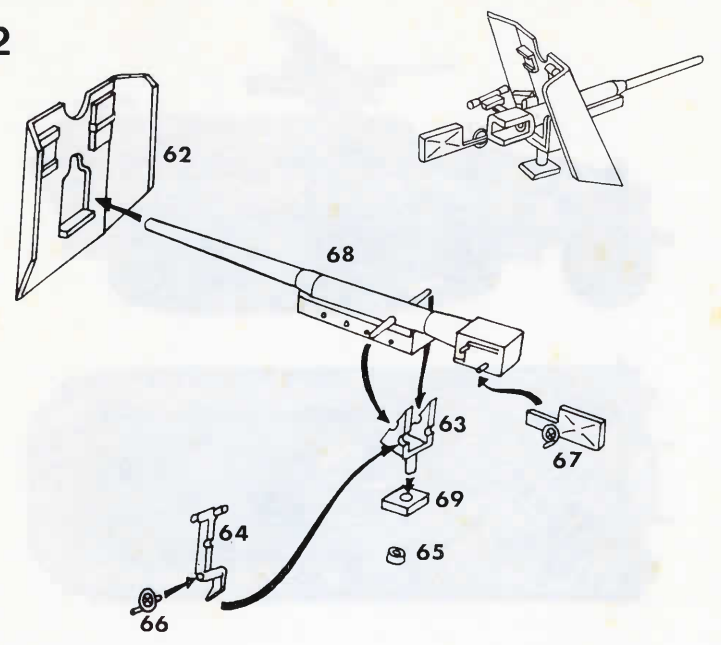



4

35

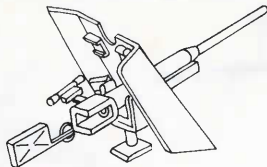

33

45

53

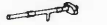

60

52

28



29

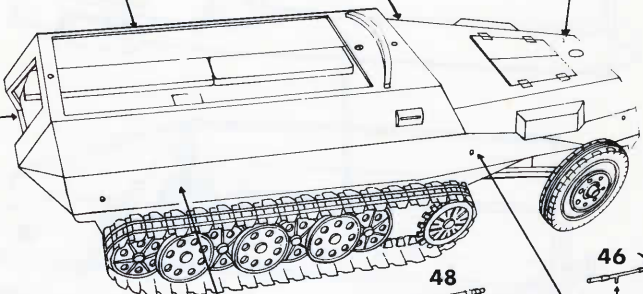

54

48

46

61

43

32

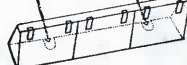

44



34

28



26

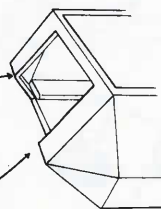

75



76

77

72



71

74

29

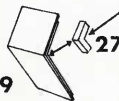

27

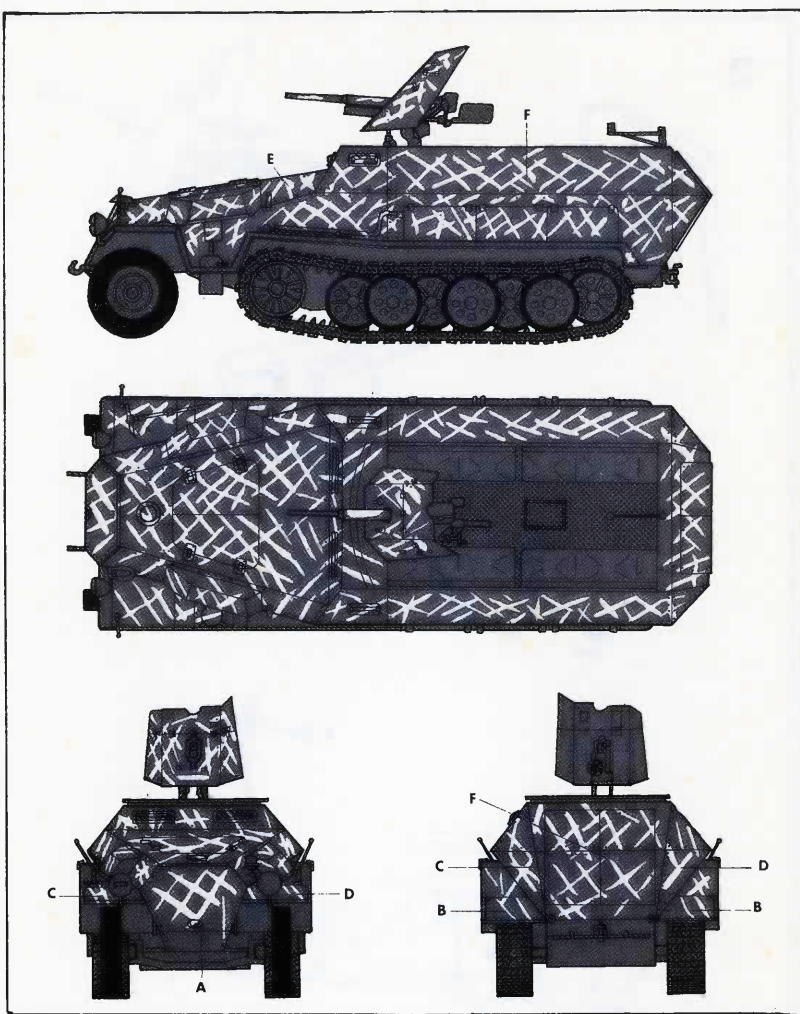

WH-652130	A	WH-652130	B	WH-652130	C	T	D	T
WH-816179	A	WH-816179	B	WH-816179	Y	C	Y	T
WH-374050	A	WH-374050	B	WH-374050	D	D	T	D
WH-235105	A	WH-235105	B	WH-235105	+	C	+	T
WH-235105	A	WH-235105	B	WH-235105	+	E	+	T
WH-235105	A	WH-235105	B	WH-235105	+	F	+	T



MADE IN ITALY  
 Hanomag 251/10  
 KIT. 8053