

BEECHCRAFT AT-11 KANSAN

MODEL KIT / MODELLE REDUIT / MODELL BAUSATZ
1/72 ÖLÇEK / SCALE / MASSTAB / ECHELLE

Sivil Beechcraft D-18'den geliştirilerek üretilen Beechcraft AT-11 Kansan, II.Dünya Savaşı sırasında A.B.D Kara Havacılığının standart bombardımcı ve silahçı eğitim uçağıydı. Kara Kuvvetleri için 1582, Deniz Kuvvetleri için 320 uçak (SNB-1) üretildi. AT-11 sırtında .30 kalibrelik bir makinalı tüfek ile on adet 100 poundluk eğitim bombası taşıyabiliyordu.

TEKNİK ÖZELLİKLERİ

Motor	: 2XPW R-985 Wasp	Tam yükte ağırlık	: 3962 kg.
Gücü	: 450 hp.	Maks. Sürat	: 360 km/h
Kanat genişliği	: 14.52 mt.	Uçuş tavanı	: 6100 mt.
Gövde boyu	: 10.43 mt.	Uçuş menzili	: 1370 km.
Yükseklik	: 2.84 mt.	Silahları	: —

Developed from the civil Beechcraft D-18, the Beechcraft AT-11 Kansan was the standart U.S.Army Air Corps bombing and gunnery crew trainer during the Second world war.A total of 1582 aircraft were built for the Army and another 320 aircraft(SNB-1) for the U.S Navy. The AT-11 could carry a single .30 caliber machine gun in the dorsal position and ten 100 pound practice bombs.

SPECIFICATION

Engine	: 2XPW R-985 Wasp	Loaded weight	: 8726 lb.
Max. power	: 450 hp.	Max. speed	: 216 mph.
Wing span	: 47 ft. 9 inch	Ceiling	: 20.000 ft.
Lenght	: 34 ft. 4 inch	Range	: 850 mls.
Height	: 9 ft. 9 inch	Armament	: —

Die At-11 Kansan, entwickelt aus der zivilen Beechcraft D-18, war das Standardflugzeug für das U.S. Army Bomben und Bortschützenttraining während des zweiten Weltkrieges. 1582 Flugzeuge wurden für die Army und weitere 320 Stück (SNB-1) für die Navy gebaut. Die AT-11 konnte eine einzelne 30 Schub Maschinenpistole mitführen und zehn 100 pfund schwere Bomben.

TECHNISCHEN DATEN

Triebwerk	: 2XPW R-985 Wasp	Abfulggewicht	: 3962 kg.
Startschub	: 450 kp.	Höchstgeschwindigkeit	: 346 km/h
Spannweite	: 14.52 m.	Dienstgipfelhöhe	: 6100 m.
Lange	: 10.43 m.	Reichweite	: 1370 km.
Höhe	: 2.84 m.	Bewaffnung	: —

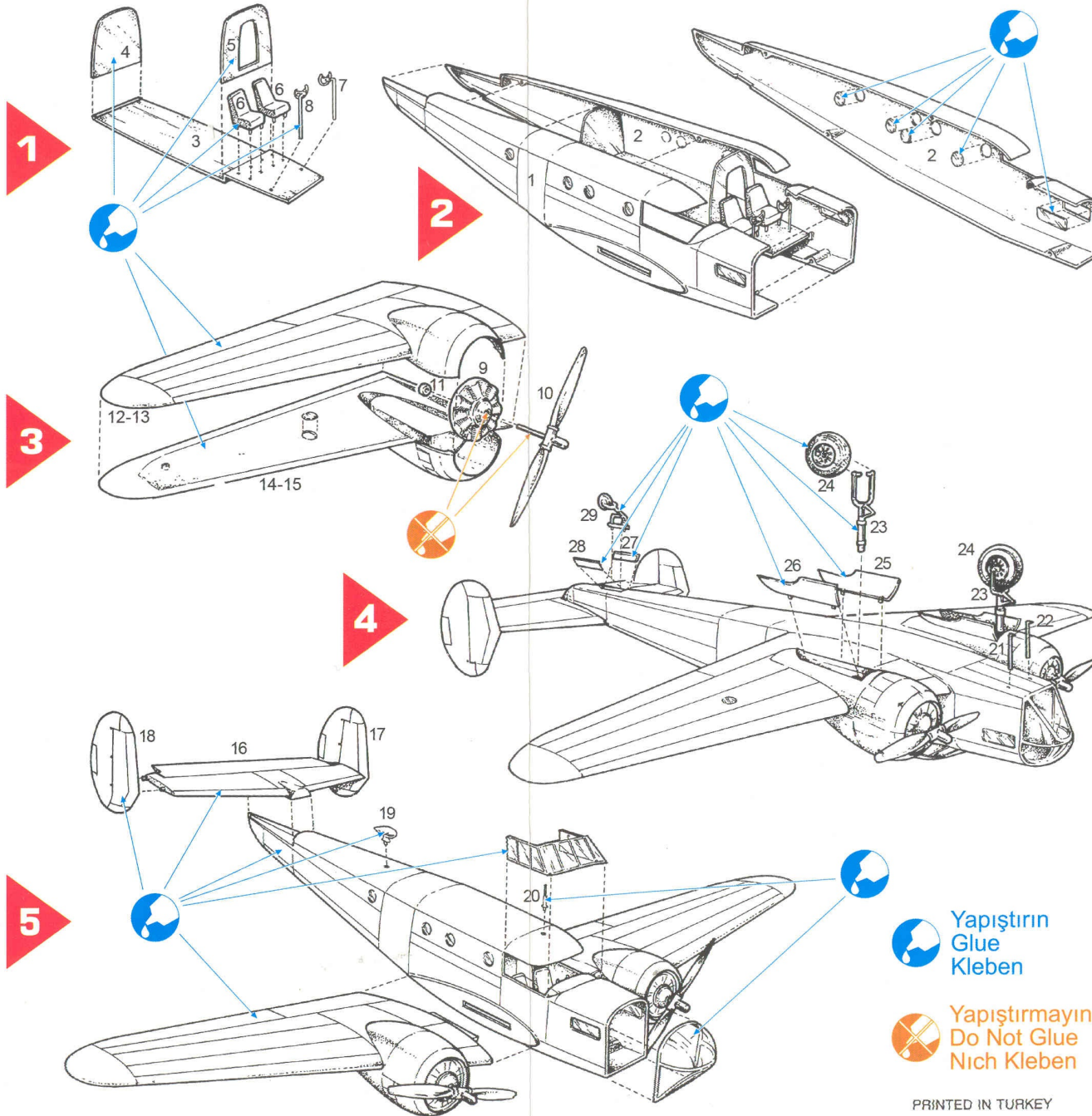

 **Yapıştırın**
Glue
Kleben

 **Yapıştırmayın**
Do Not Glue
Nich Kleben

PRINTED IN TURKEY

ABD Kara Ordusu Havacilili Gurubu 1942
U.S. Army Corps 1942

BEECHCRAFT AT-11 KANSAN

Türk Hava Kuvvetleri 1970
Turkish Air Force 1970

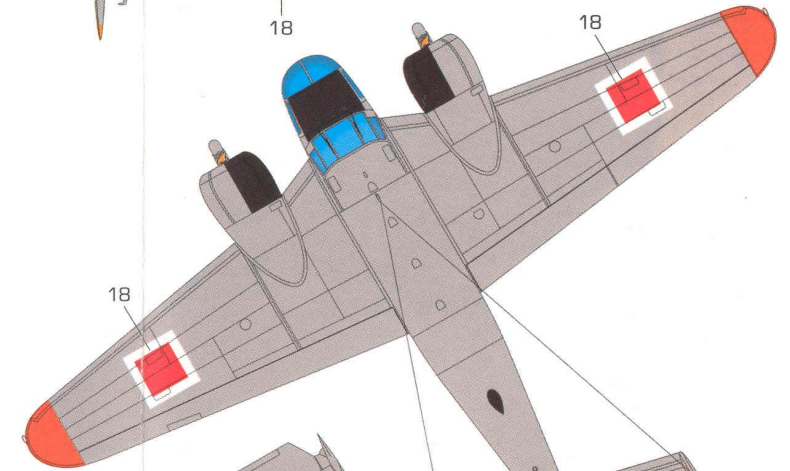
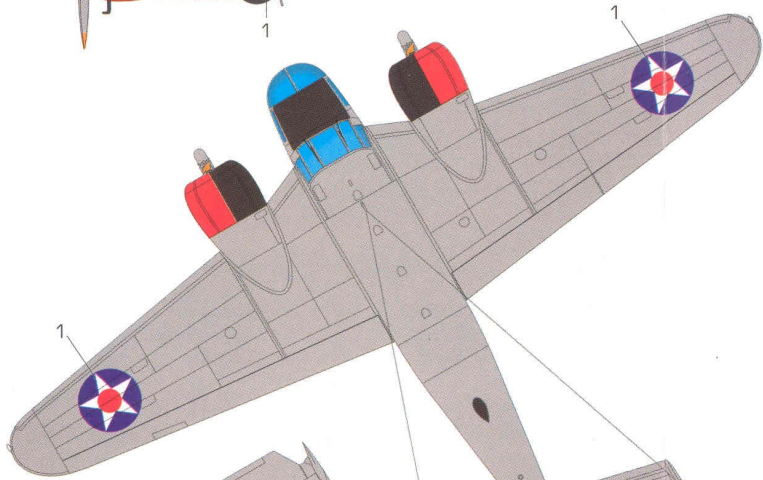
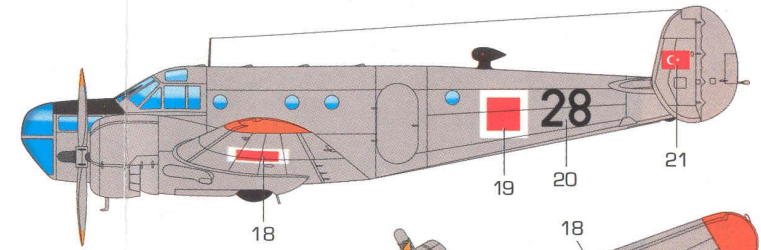
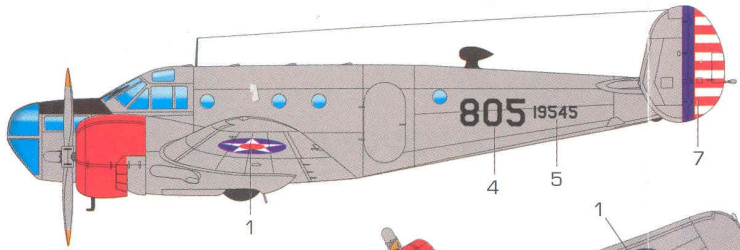

Metal Humbrol 011
Natural Metal M. Master 2714
Silber Gunze S. H-8
FS 17178 Xtra Color X-501



Mat Siyah Humbrol 33
Matt Black M. Master 1749
Mattschwarz Gunze S. H-12
FS 37038 Xtra Color X-012



Kirmizi Humbrol 174
Signal Red M. Master -
Signal Rot Gunze S. H-23
FS 31302 Xtra Color X-14



Turuncu Humbrol 192
Orange M. Master 1775
Leucht Orange Gunze S. H-98
FS 28015 Xtra Color X-253

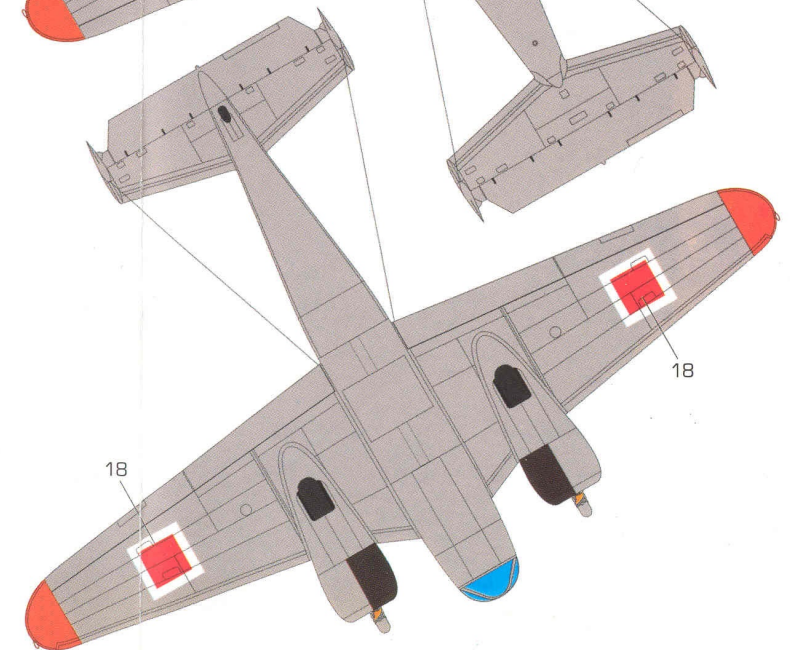
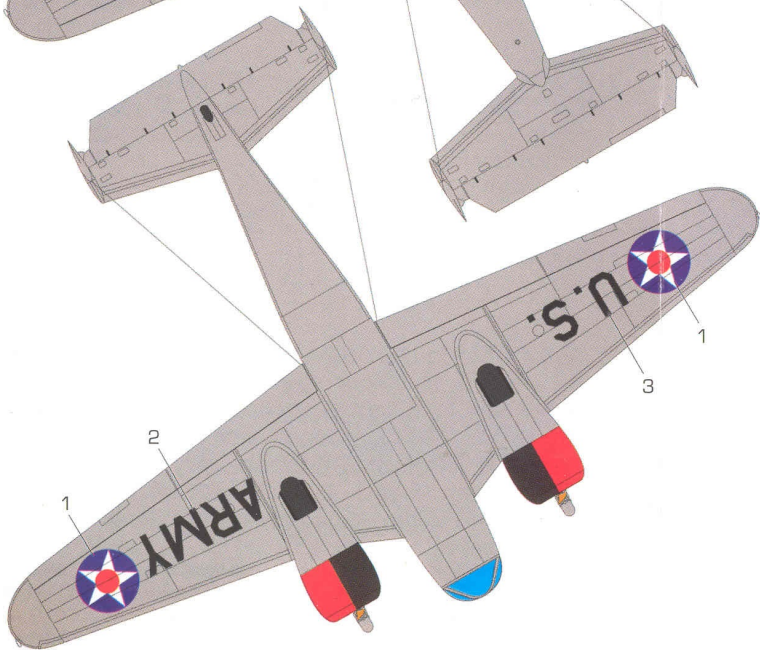

Beechcraft AT-11 Kansan - Brazilian Air Force / Brezilya Hava Kuvvetleri

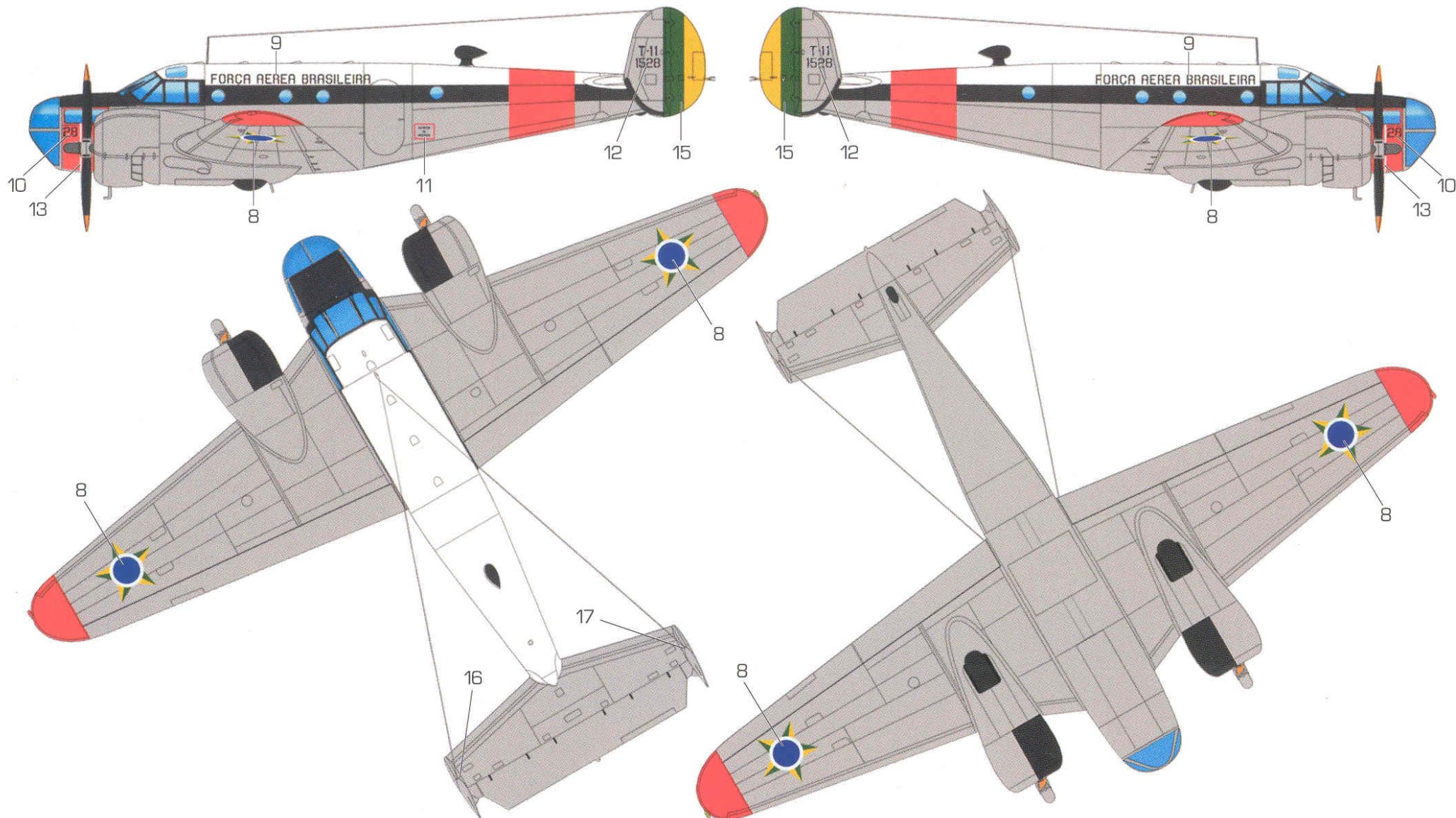

Metal	Humbrol 011
Natural Metal	M. Master 2714
Silber	Gunze S. H-8
FS 17178	Xtra Color X-501

Mat Siyah	Humbrol 33
Matt Black	M. Master 1749
Mattschwarz	Gunze S. H-12
FS 37038	Xtra Color X-012

Kırmızı	Humbrol 153
Signal Red	M. Master 4714
Signal Rot	Gunze S. H-327
FS 31136	Xtra Color X-103

Beyaz	Humbrol 22
Gloss White	M. Master 4696
Glänzend weiß	Gunze S. H-316
FS 17875	Xtra Color X-141