

**AZmodel**  
Plastic kits

British fighter

# Supermarine Spitfire Mk.VIII "RAAF"

UNASSEMBLED MODEL KIT. CEMENT AND PAINT NOT INCLUDED. 組み立て式プラスチックモデルキットです。1セット分のプラスチックパーツが入っています。接着剤と塗料はこのキットに含まれておりません。別途お買い求め下さい。

**1/72**

Scale model kit

スケールモデルキット

Illustration/ 図:  
Z. Macháček

**AZ 7518**

Box contains:

• plastic parts

• decal sheet  
for 3 versions

• full colour  
instructions



# Supermarine Spitfire MK VIII

Plastic model

scale :1/72

The Supermarine Spitfire is a British single-seat fighter aircraft that was used by the Royal Air Force and many other Allied countries throughout the Second World War. Although the original airframe was designed to be powered by a Rolls-Royce Merlin engine producing 1,030 hp (768 kW), it was adaptable enough to use increasingly powerful Merlin. During 1941 work began on adapting the Spitfire to use the new Merlin 61 engine. This had a two-stage supercharger, which improved its performance at high altitude by around 50%. The Mk VIII (and VII) featured a strengthened fuselage with a retractable tail wheel. Each wing carried a 14-gallon self sealing fuel tank, and the main fuselage fuel tank was increased in size to 96 gallons.

### Warning before you start building the model:

This model is made of injection into the epoxy mould (short-run) and is manufactured in a limited quantity. This technology has certain technological limits and the kits are therefore more laborious to build. Please, do not compare these models with conventional ones produced from metal moulds. All parts and surfaces destined for cementing should be thoroughly cleaned and dry fitted before assembly and in case of need to be appropriately modified. For cementing the plastic parts together standard plastic model glues are recommended to be used. For colouring use ordinary paints. The paint numbers referred to in our kits are Humbrol colour samples.

Master model: Petr Muzikant

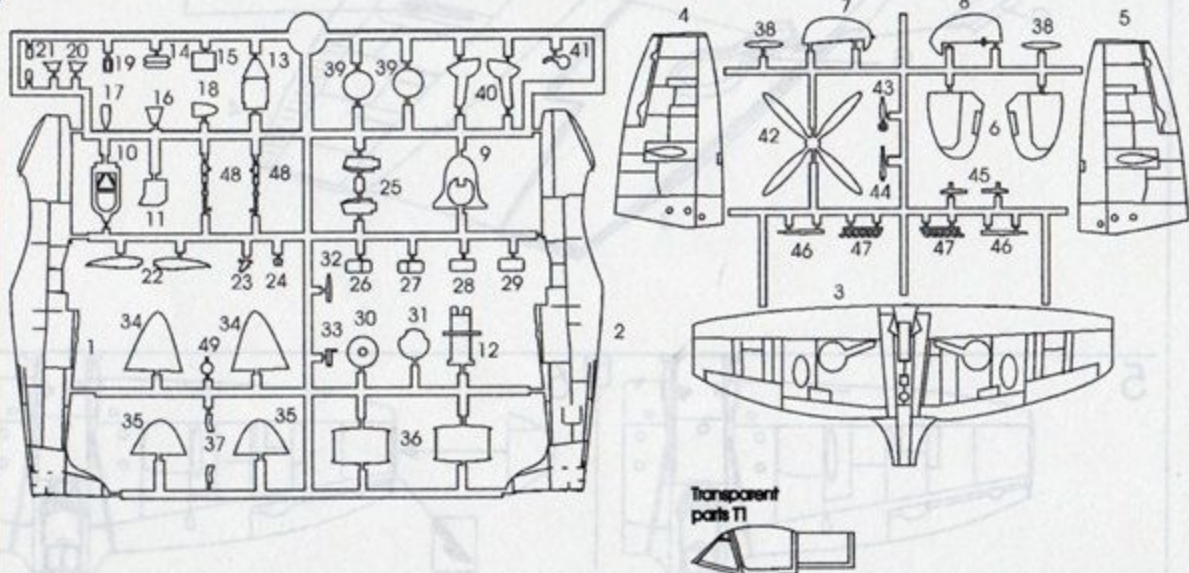



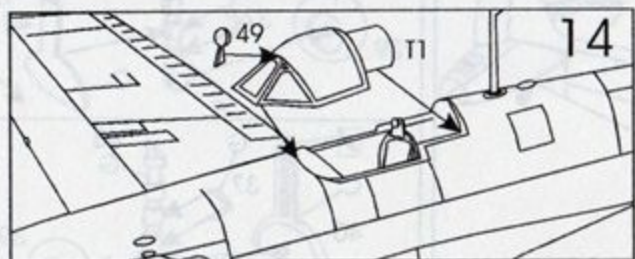

Decals position: Supermarine Spitfire Mk VIII

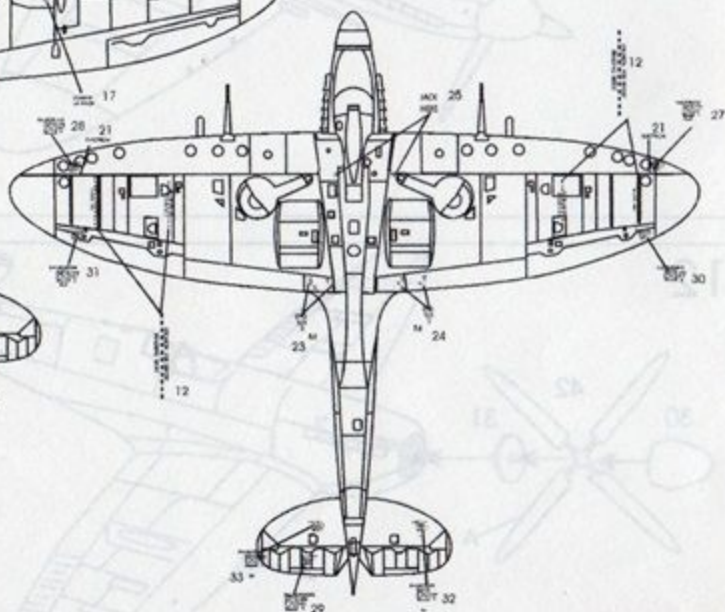
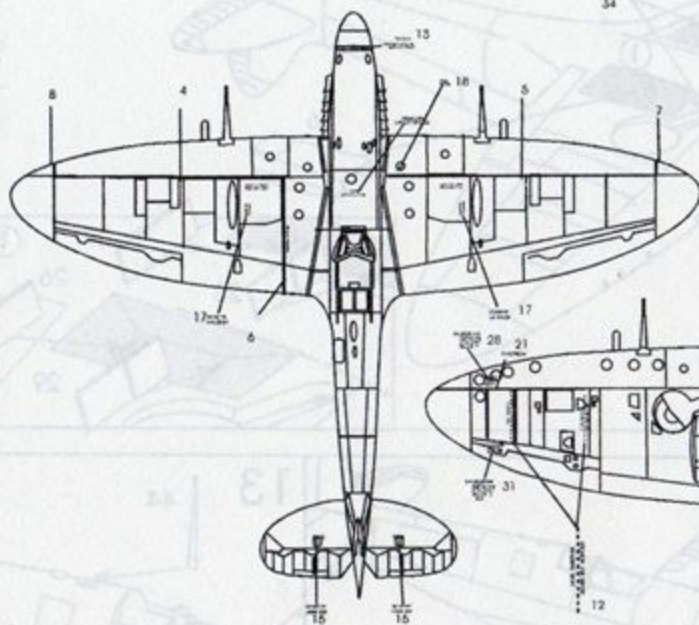
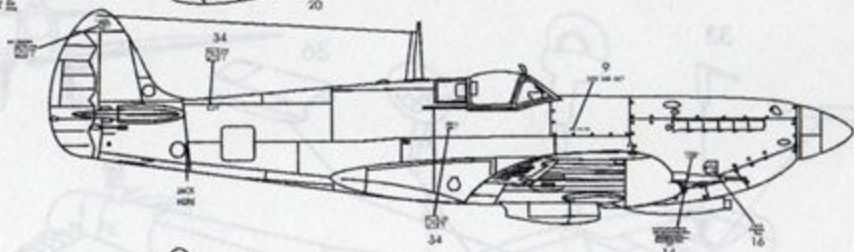
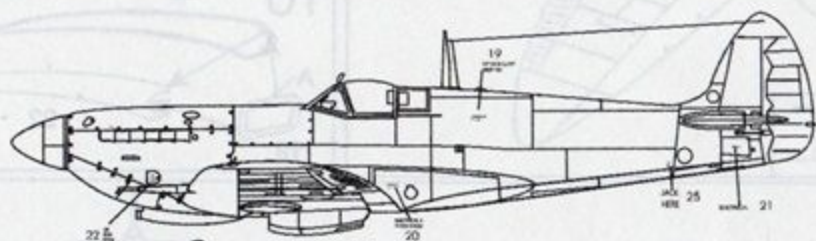

## Colours & Markings

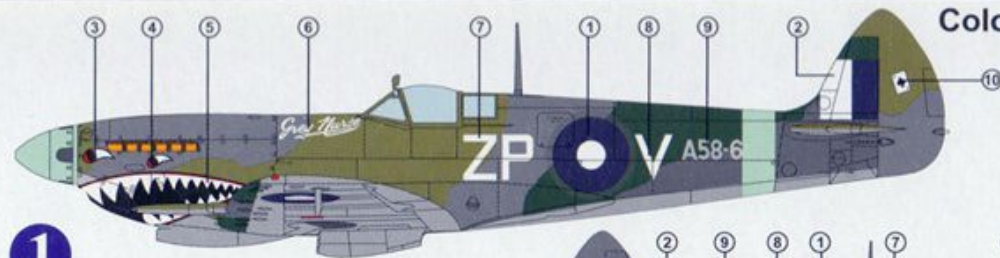

**1**

A58-631, flown by F/L George Scrimgeour,  
No. 457 Squadron, Labuan, Borneo, June, 1945

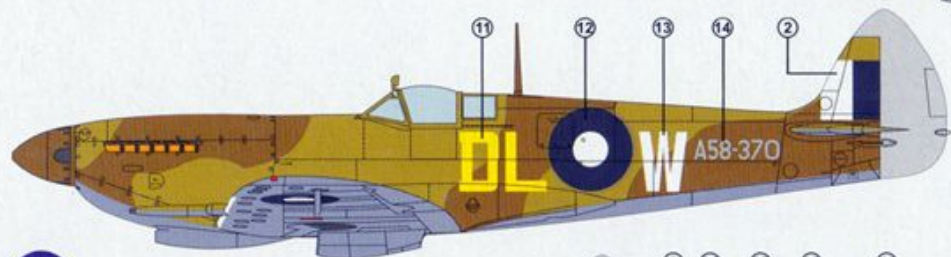
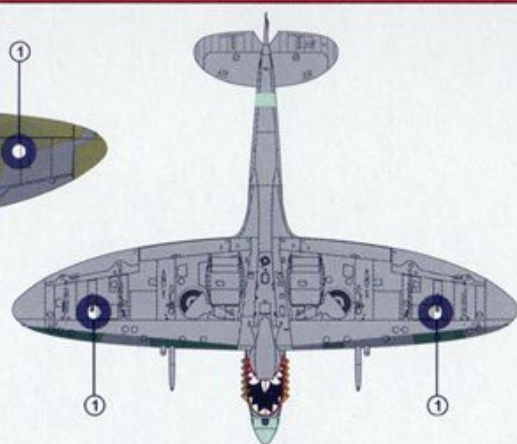
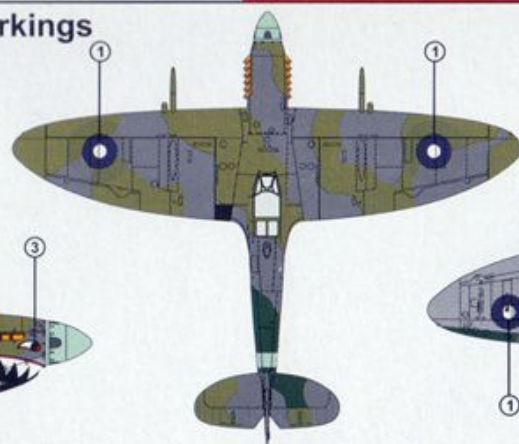
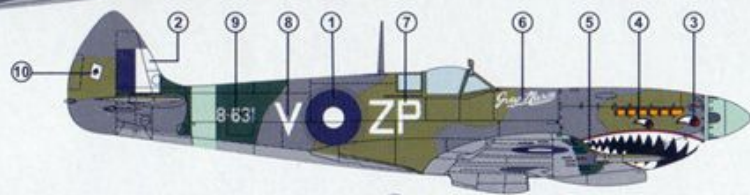

**2**

A58-370, No. 54 Squadron, Darwin Civil  
Aerodrome, May, 1945

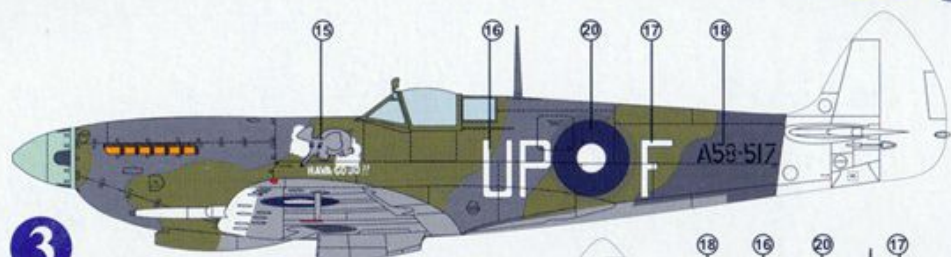
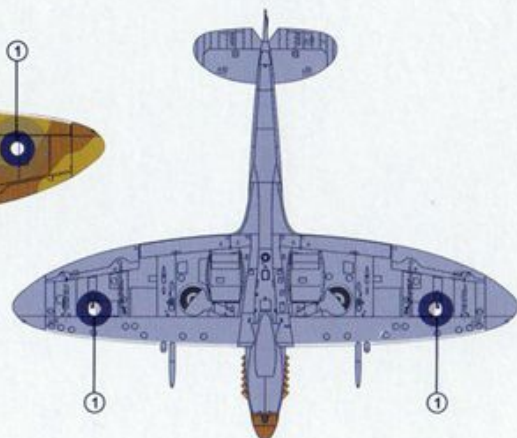
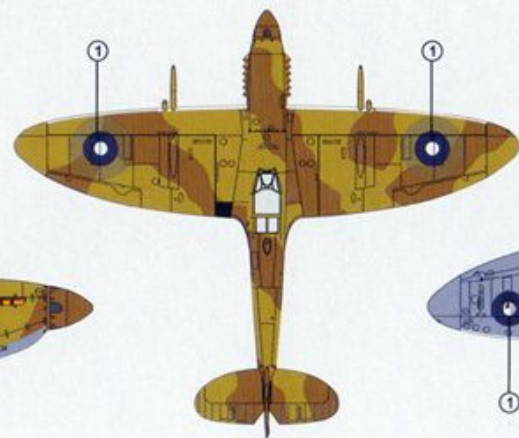
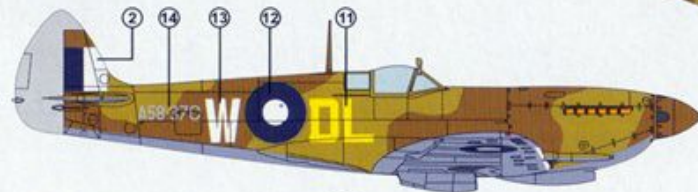

**3**

A58-517, flown by F/O Norm Turnbull,  
No. 79 Squadron, Morotai, April, 1945

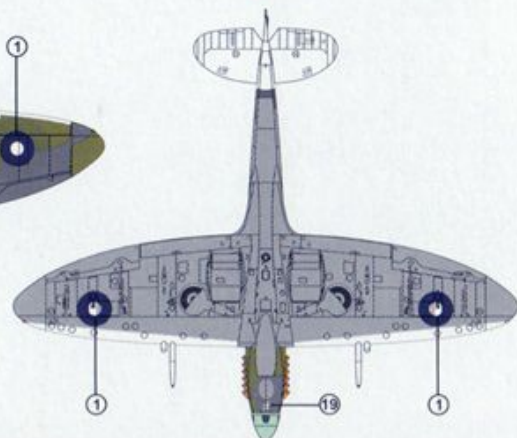
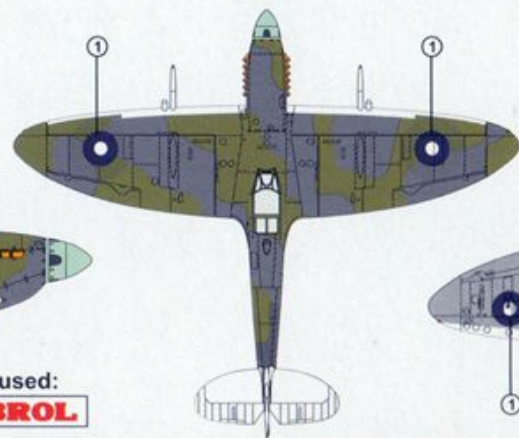
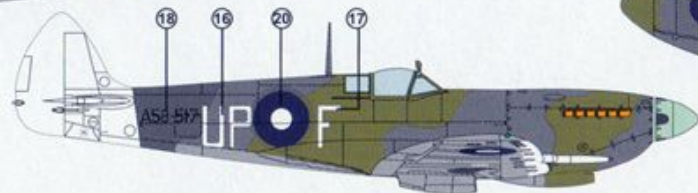

30 149 106 123 64 29 84 157 34 90

Dark Green Foliage green Ocean Grey Dark Grey Medium Grey Dark Earth Mid Stone Azure Blue White Sky

Paints used:  
**HUMBROL**