

LOCKHEED F-104 STARFIGHTER

PRODUCED IN THE REVOLUTIONARY

AUTHENTI-PLATE FINISH

AUTHENTI-PLATE is a process which deposits a coating of aluminum to plastic. A clear, protective coating of lacquer is then applied to prevent the finish from rubbing off due to handling.

Plastic cement will not hold to the plated finish, therefore, during assembly, you must remove the plating wherever cement is to be applied to join two parts. **IT IS IMPORTANT THAT THIS STEP IS DONE.**

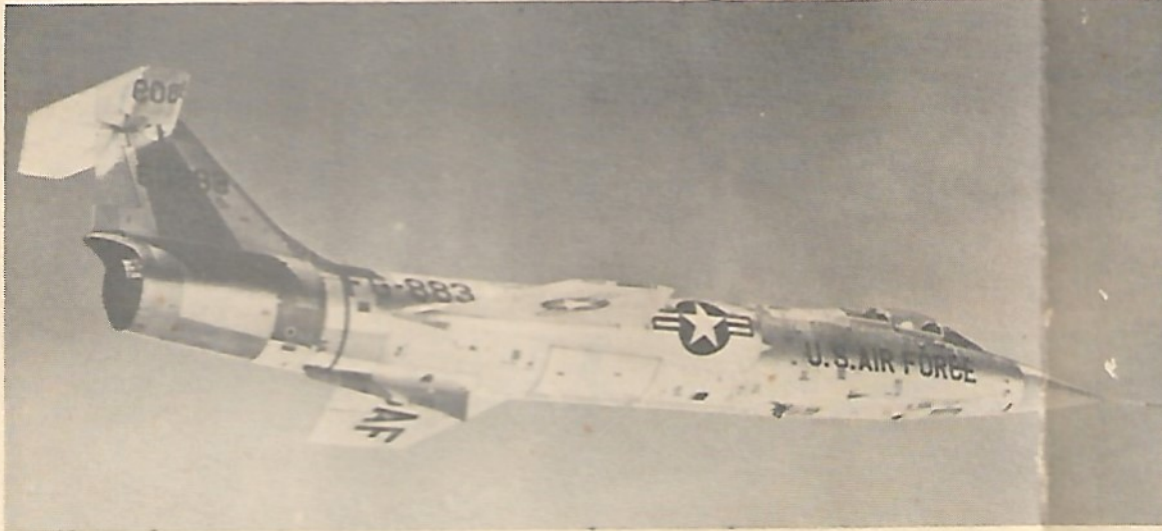

UNITED STATES AIR FORCE F-104C

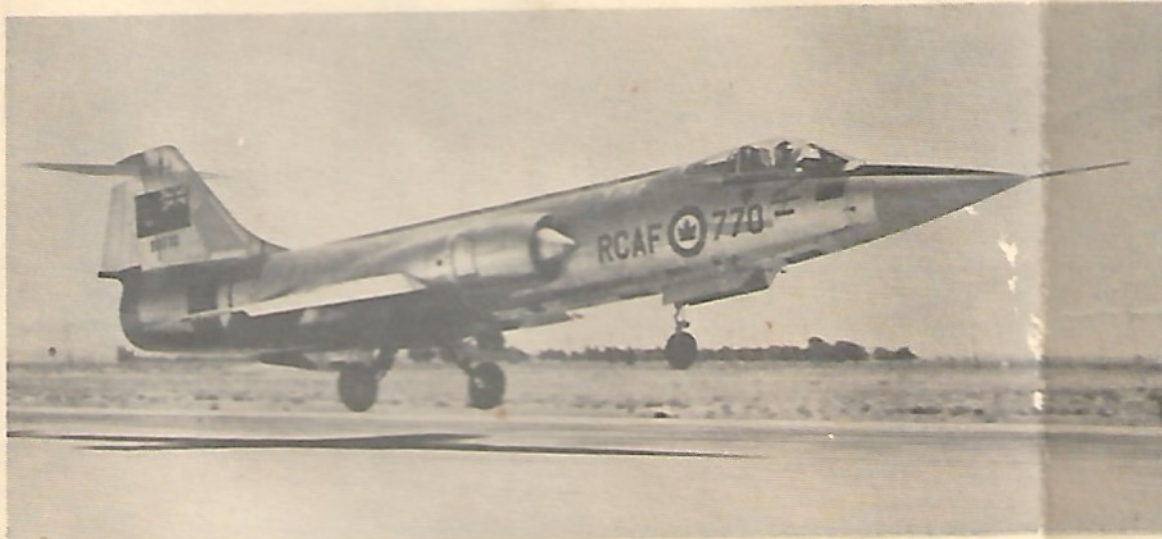

ROYAL CANADIAN AIR FORCE CF-104



WEST GERMAN AIR FORCE F-104G



HAWK MODEL CO.
620 BUCKBEE STREET
ROCKFORD, ILLINOIS 61101

KIT No. 203-200

COPYRIGHT © HAWK, 1961

MADE AND PRINTED IN U.S.A.

The Starfighter Story . . .

The Lockheed F-104A Starfighter is an air superiority day fighter of advanced design. The aircraft has a length of 54 ft. 9 in. It has a span of 21 ft. 11 in. Height of the aircraft is 13 ft. 6 in. Powerplant is a General Electric J79-GE-3A axial flow turbojet with afterburner. This engine has an approximate thrust of 10,000 pounds with afterburner out and 15,000 pounds with afterburner in.

Armament of the F-104A is an M61 six-barrel cannon, however, almost all F-104A aircraft are armed with Sidewinder infra-red missiles when assigned to interception missions. The M61 cannon is then removed and extra fuel tanks placed in the cannon's place.

Normal fuel load of the Starfighter is carried in fuselage tanks with provisions for wingtip fuel tanks and underwing pylon tanks. The F-104A is not equipped for in-flight refueling.

Top speed of the Starfighter is in the order of Mach 2, or, twice the speed of sound. The airframe design is estimated to possess a speed potential of Mach 2.2 to 2.4. Speed limitation of Mach 2 is imposed due to aerodynamic heating of air entering the engine and the danger of this hot air damaging the compressor section of the powerplant.

The first prototype of the Starfighter flew for the first time in February of 1954. Two years later, after an extensive test program, the first production F-104A lifted into the air.

Numerous developments on the basic Starfighter theme have come into being. The F-104B is the two-seat version of the A. The F-104C is a fighter-bomber development with a two-seat version called the F-104D. The F-104G Super Starfighter is a redesign with internal changes suiting the F-104 for NATO missions. The F-104F is the two-seat version of the F-104G. The F-104J, being built for Japan, is a progressive development of the F-104C.

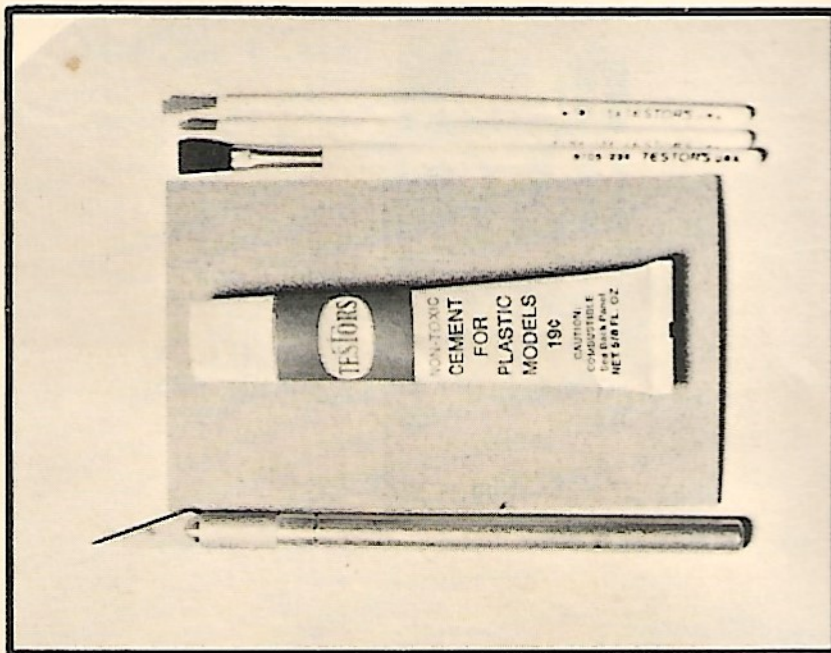

The tools shown above are useful in completing your F-104. A knife for trimming plastic and scraping plating. Sandpaper, fine grade, for removing plating. Several sizes of paint brushes for painting and finishing. A tube of plastic cement for gluing parts together.

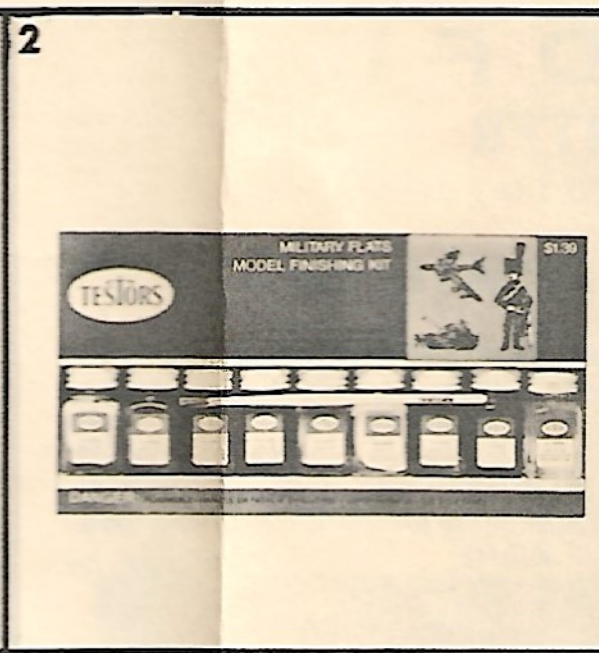

The paints shown will enable you to produce a perfect model. They are: Gloss enamel in black, white, gray, orange, red, silver. Flat enamel in black, green and flesh.

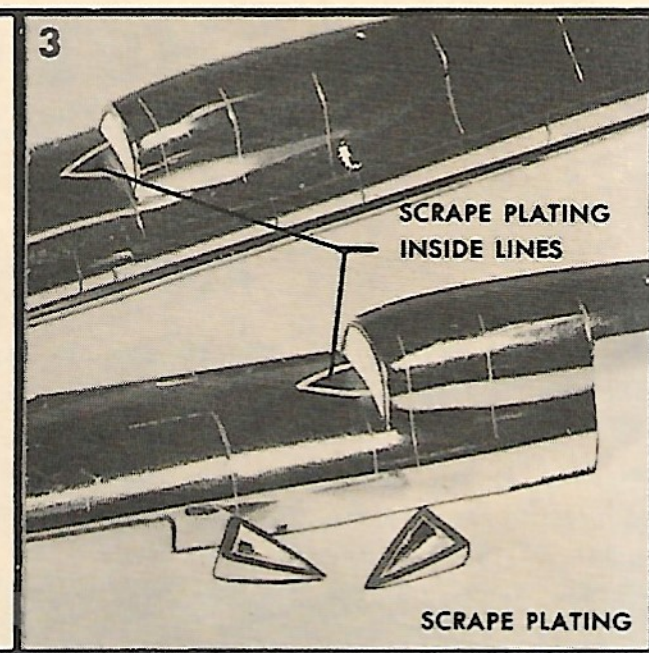

With your knife scrape the plating inside the lines marked on the fuselage halves as shown. Now scrape the plating from the intake cone edges as shown.

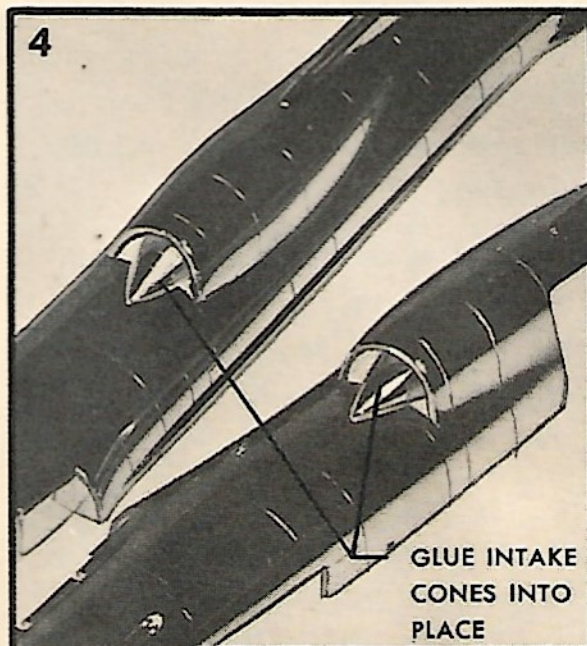

Glue the intake cones into place as indicated.

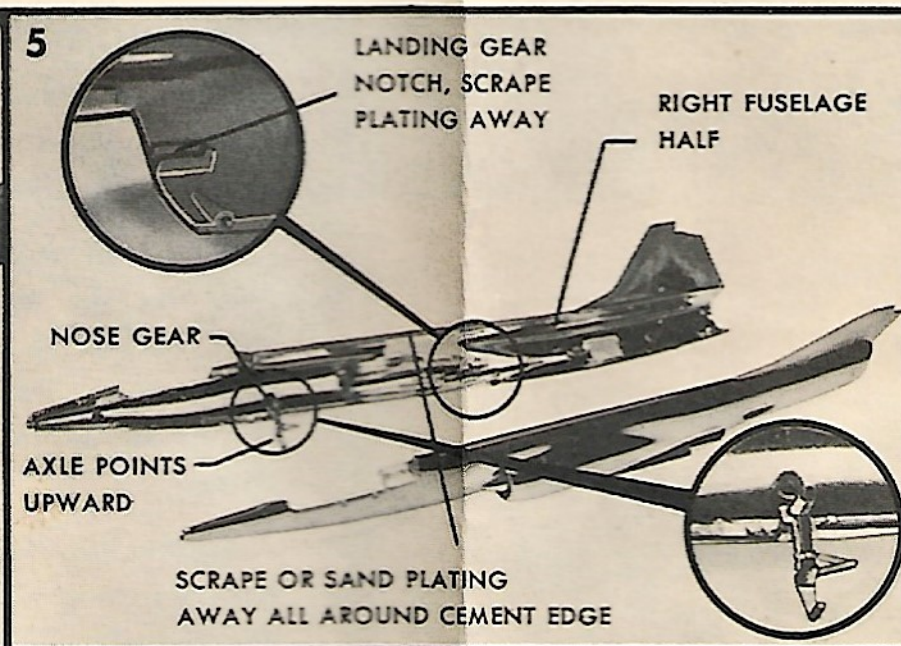

Scrape plating from fuselage gluing edges. Scrape plating from landing gear notches. Place nose gear strut into hole in fuselage right half as shown. Now glue fuselage halves together.

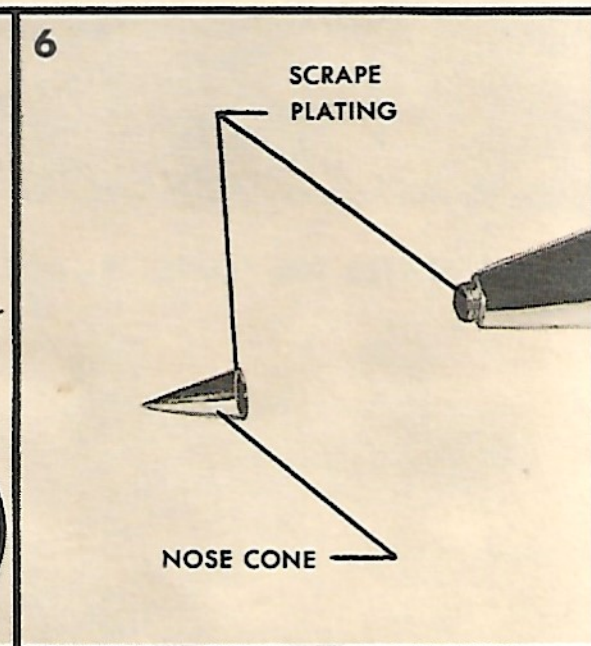

Remove plating from gluing area on nose cone and front of fuselage and cement the cone to the fuselage.

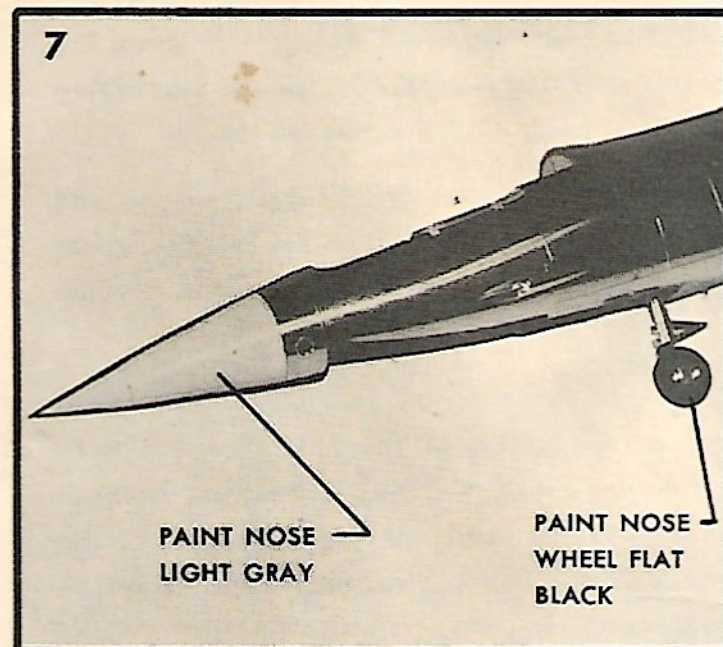

Paint the nose gloss gray as shown. Paint the tire on the smallest wheel flat black and when dry glue the tire to the strut as shown.

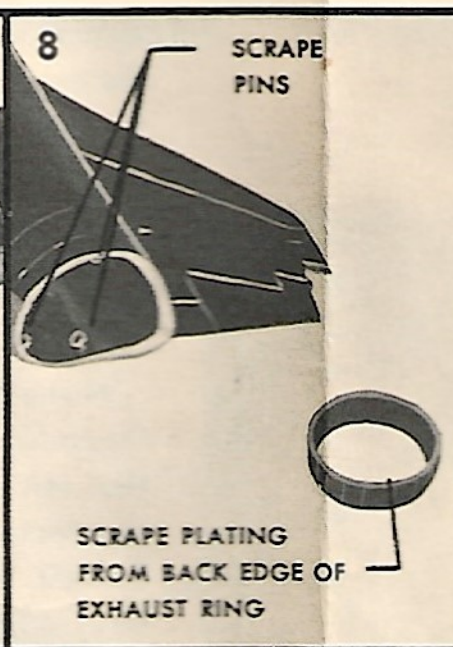

Scrape plating from the pins in the rear of the fuselage and from the back edge of the exhaust ring. Paint the ring flat black.

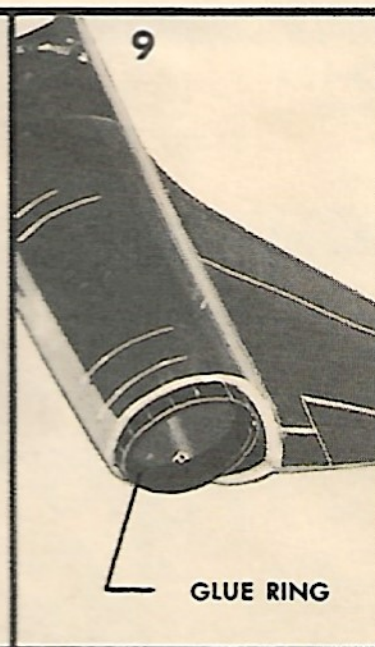

Glue the ring to the pins as shown.

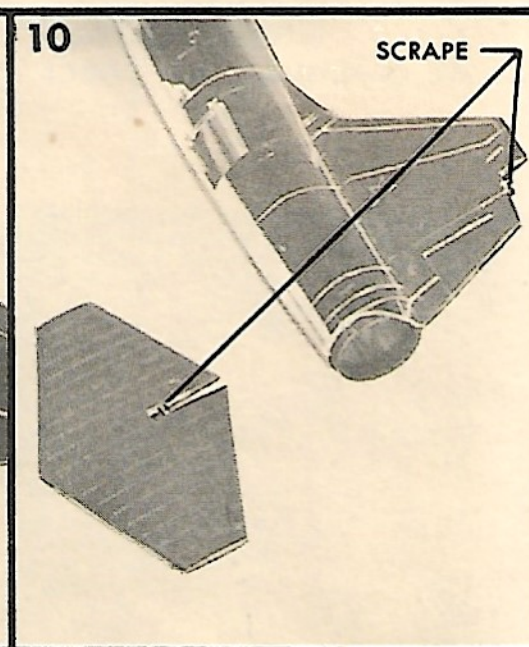

Scrape plating from the gluing areas indicated on the stabilizer and rudder.

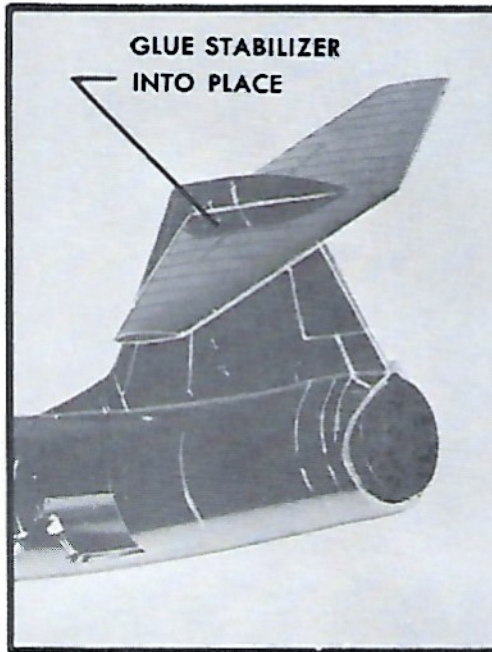

Glue the stabilizer into place.

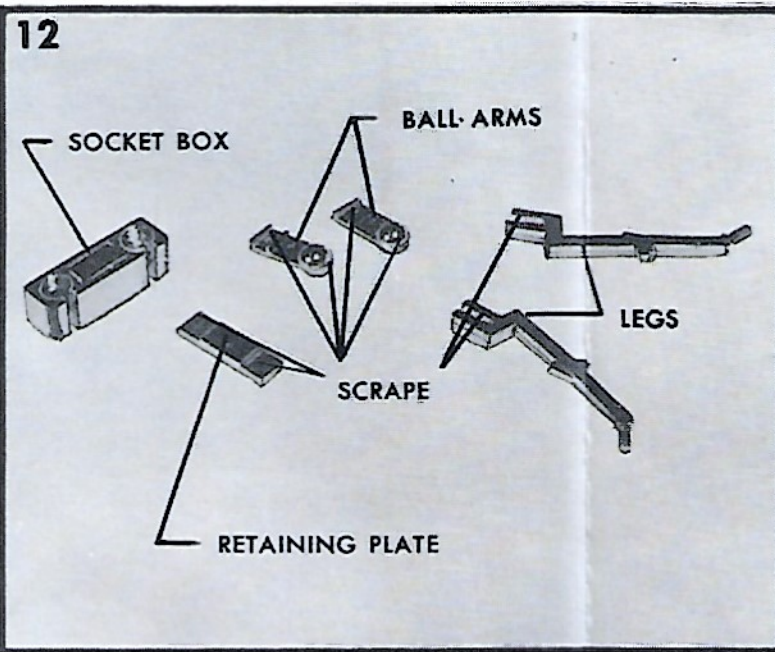

Shown above are the main landing gear parts. Scrape the plating from the areas indicated.

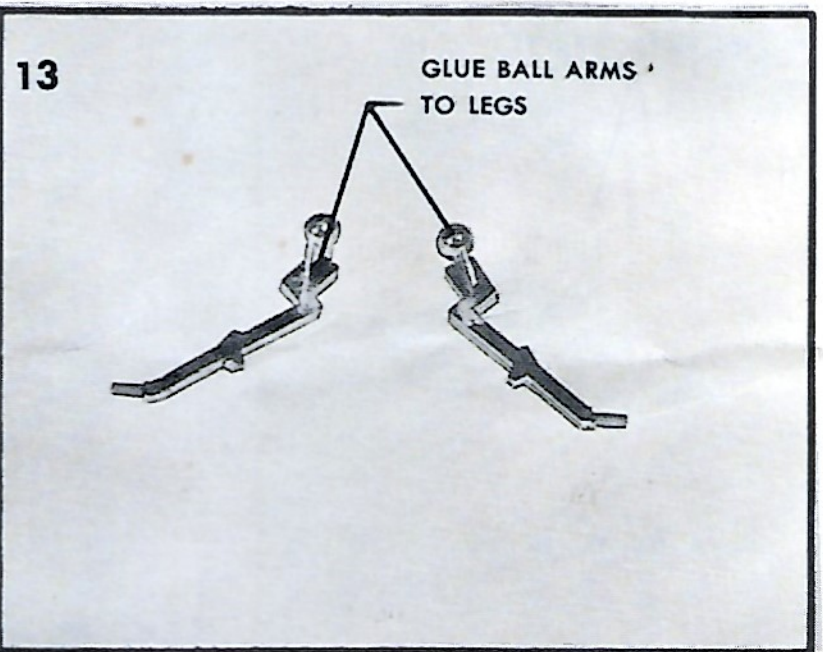

Glue the ball arms to the landing gear legs exactly as shown.

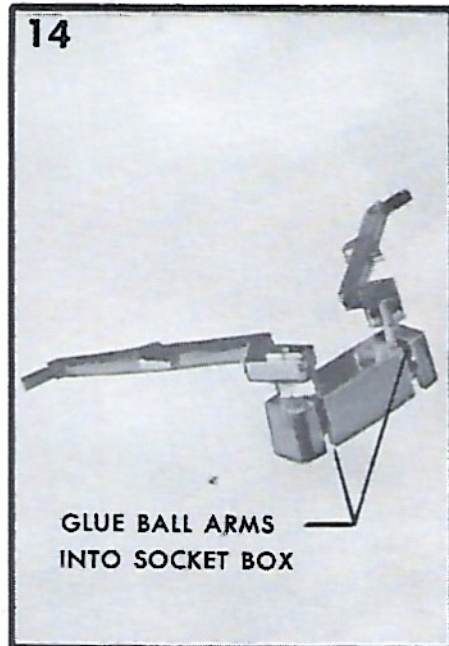

Insert the legs into the socket box and cement into place.

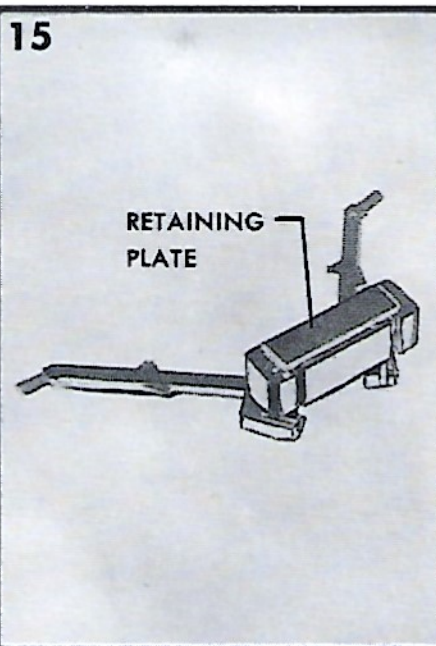

Glue the retaining plate to the ball arms and socket box as shown.

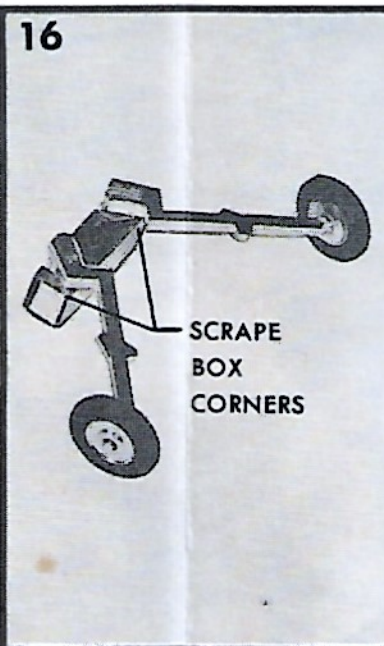

Paint the tires on the two remaining wheels (large) flat black. Glue the wheels to the axles as shown. Scrape the plating from the corners indicated on the socket box—THIS IS VERY IMPORTANT.

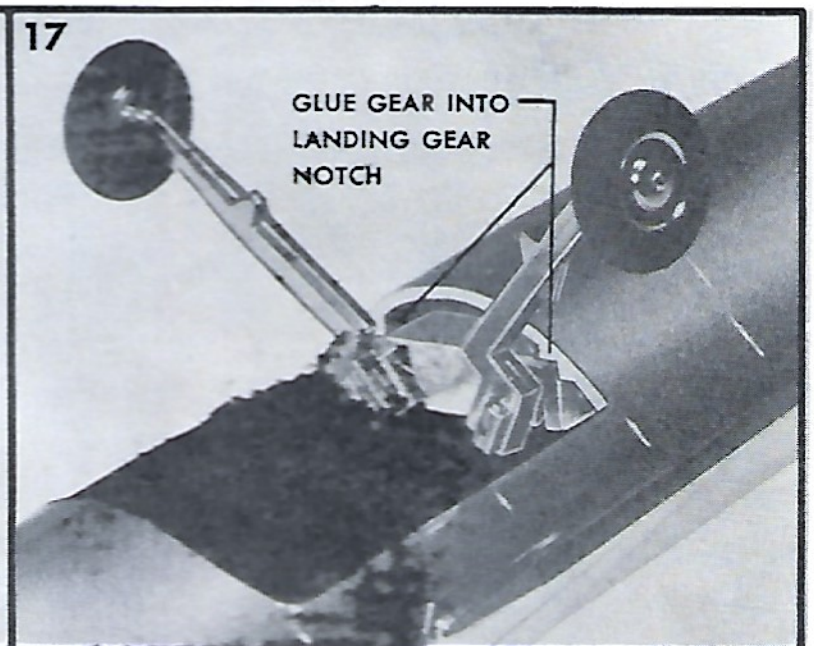

Glue the socket box into the landing gear notches as shown. Hold in position with your finger until the cement has partly dried.

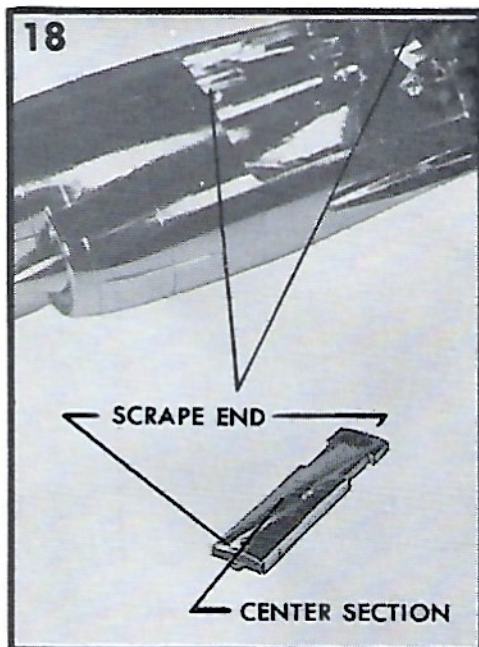

Scrape the center section ends as shown. Also scrape the forward and rear edge of the landing gear opening.

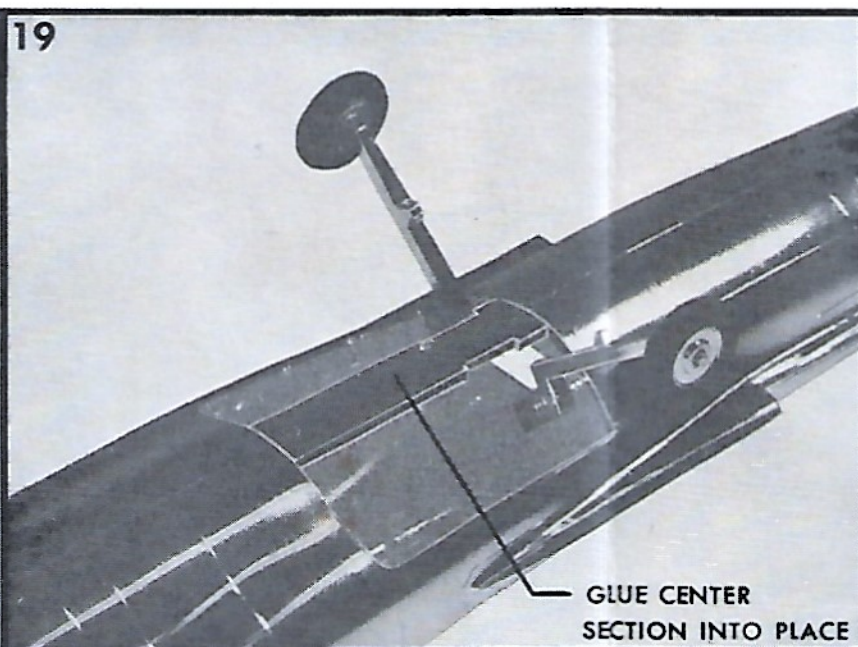

Glue the center section into place as shown. The tabs on the ends of the center section fit inside the fuselage.

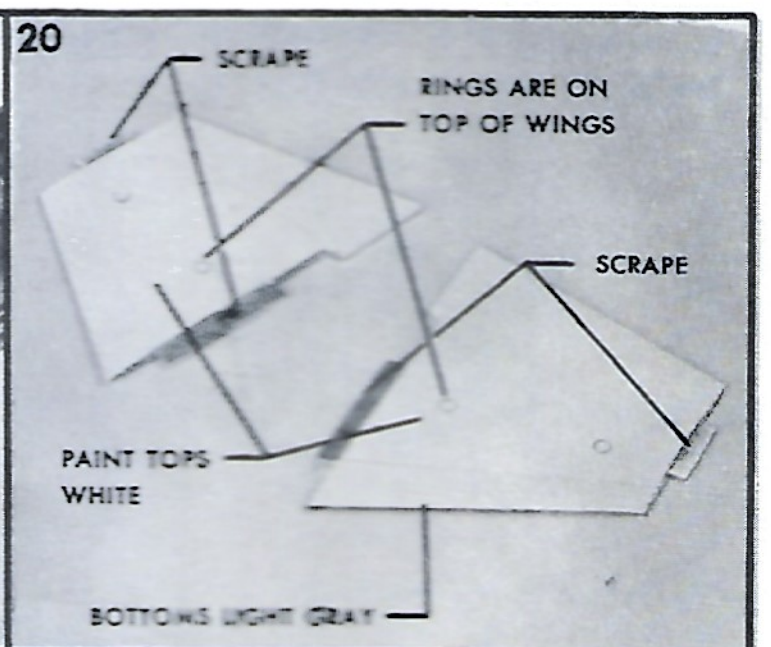

Scrape the tabs on the ends of the wings. Paint the tops of the wing glass white and the bottoms glass gray. You can tell the tops of the wings by the little raised circles. Allow time to dry before handling.

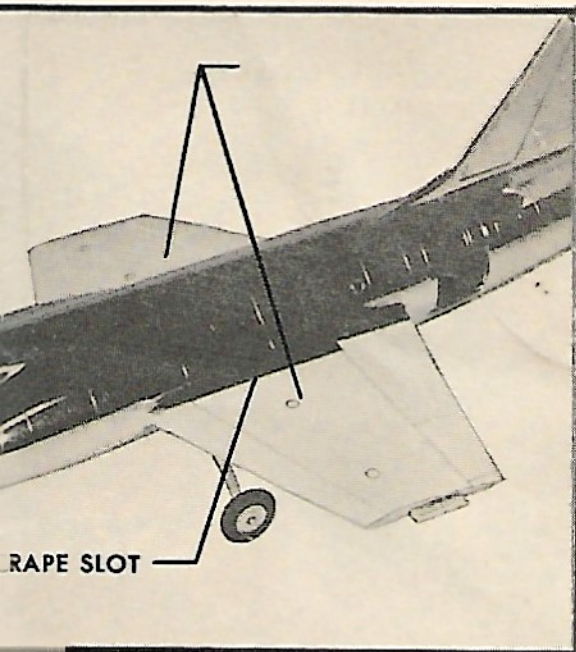

Scrape the wing fuselage slot. Now glue the tip tanks into place.

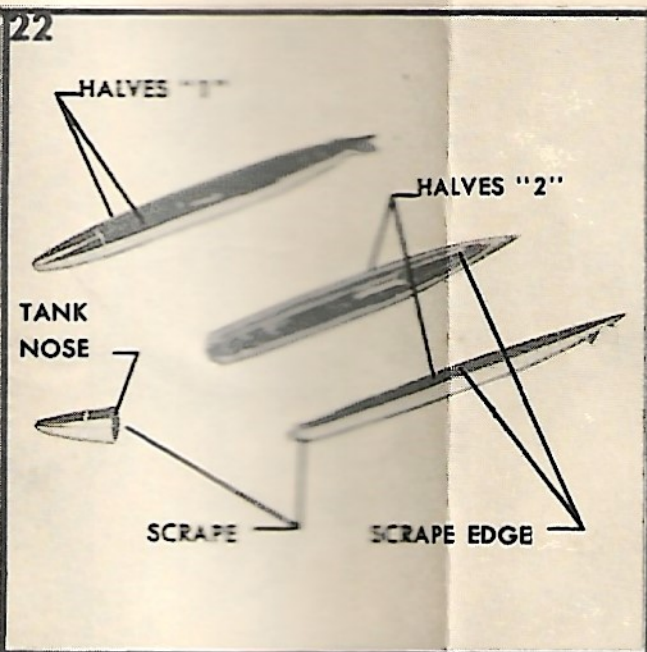

Scrape the glowing edges of the tip tank parts. Glue halves "1" together and halves "2" together. Now glue the tank noses into place.

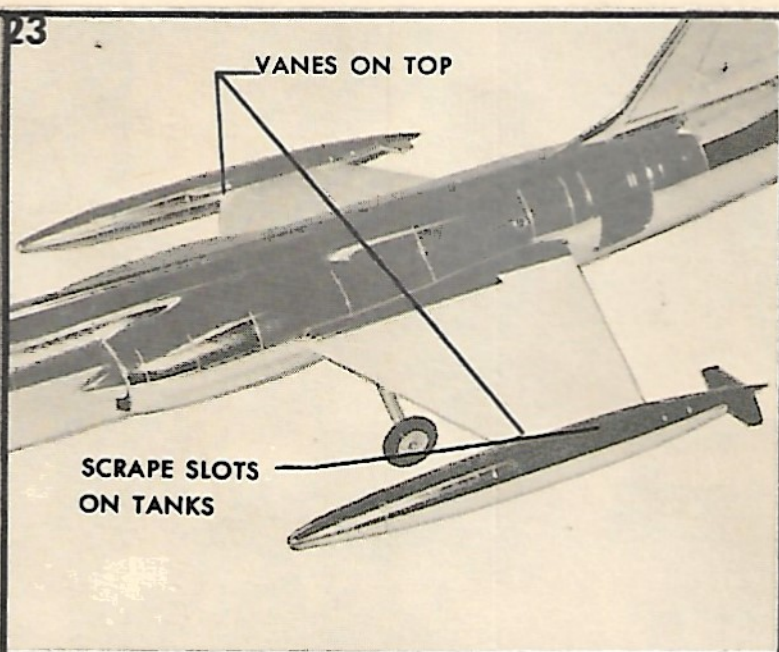

Scrape the slots on the tip tanks and glue the tanks to the wingtips. Note that the little vanes on the tanks are ABOVE the wings.



Paint the pilot figures as shown.

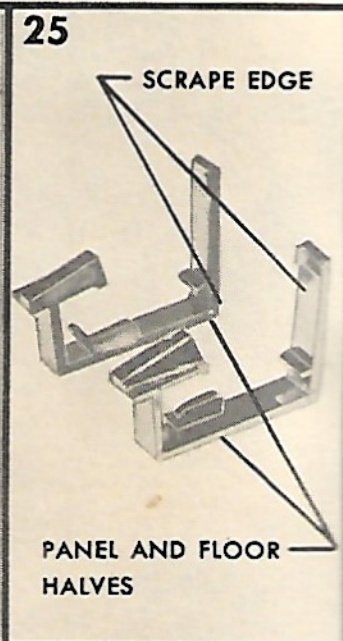

Scrape the edges of the panel and floor halves and glue together.

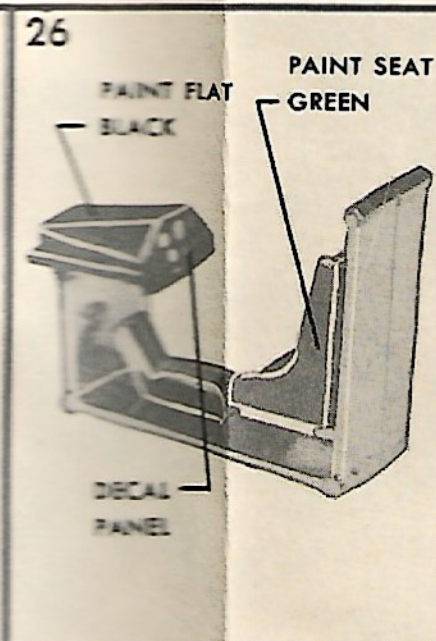

Paint the top of the panel flat black. Paint the seat flat green and cement it to the cockpit unit. Apply the decal instrument face as shown.

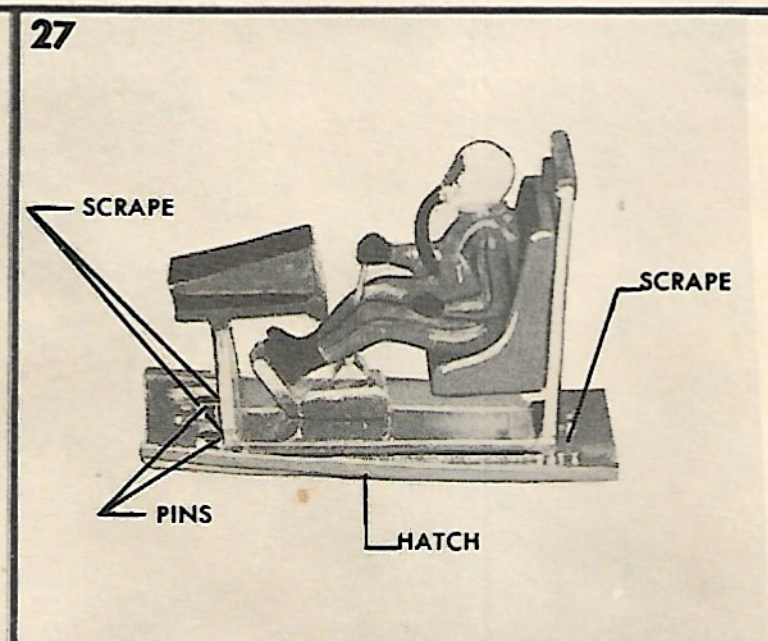

Glue the cockpit unit to the cockpit hatch as shown. Note how the front of the panel sets up against the pins on the hatch. Glue the pilot figure into place.

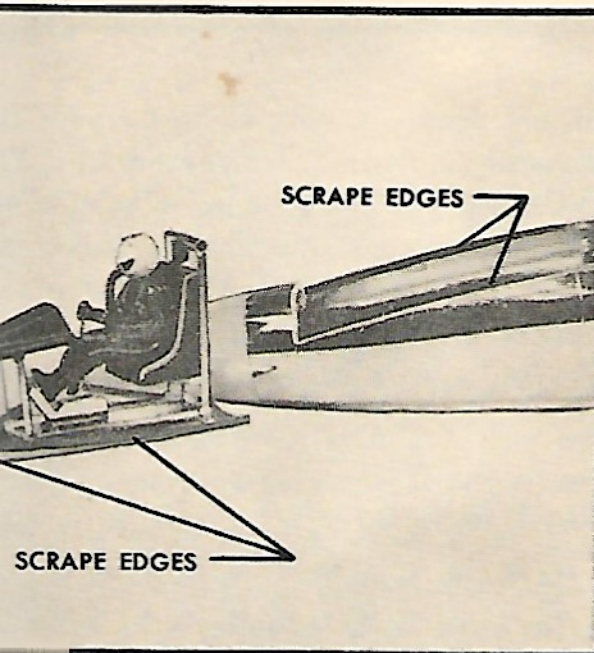

Slip the cockpit assembly into the bottom of the fuselage and glue into place.

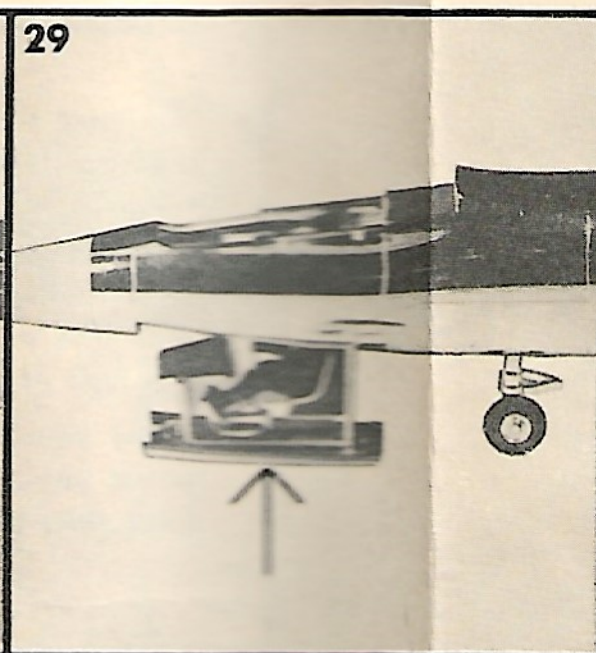

Slip the cockpit assembly into the bottom of the fuselage and glue into place.

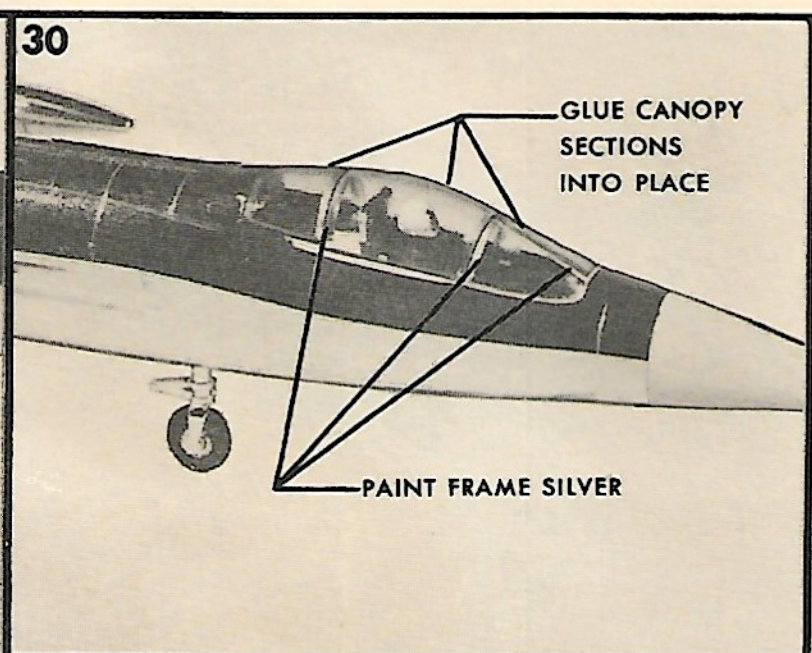

Cement the canopy sections into place. Paint the frames of the canopy silver.

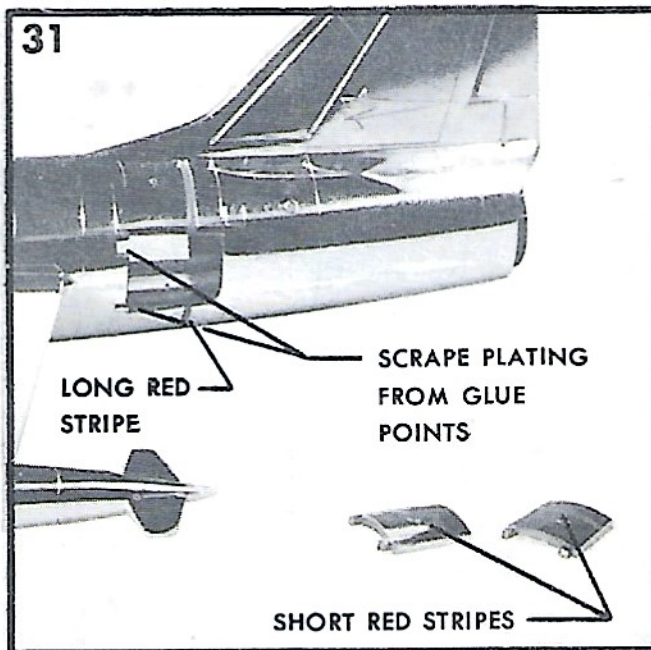

Scrape plating from gluing surfaces of the dive brakes and fuselage openings. Apply the short red decal stripes to the dive brakes. The long red stripe is applied to the bottom of the fuselage.

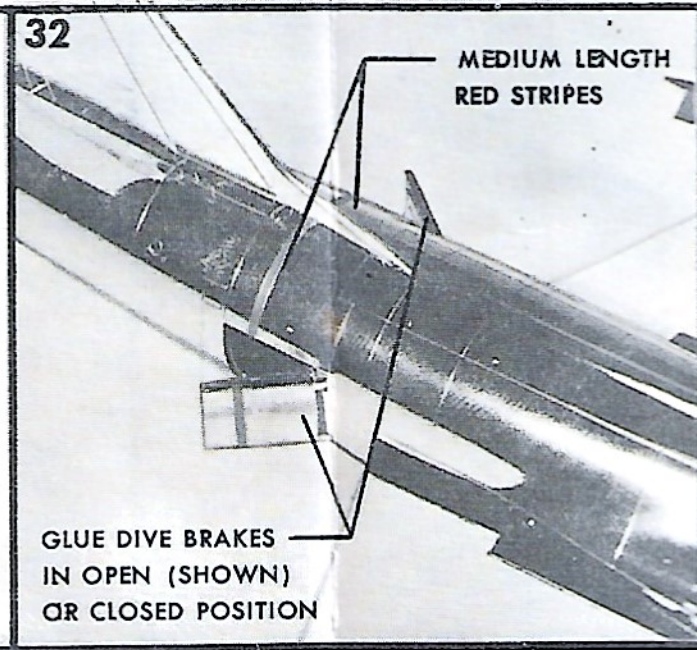

Apply the medium length red stripes as shown. Glue the dive brakes into place. They can be either in the open position (shown) or closed position.

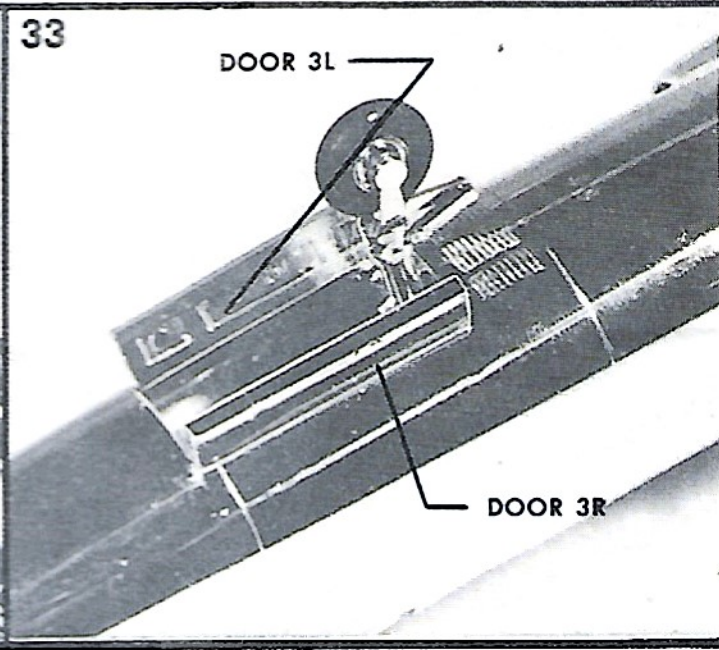

Cement nose gear doors 3R and 3L into place. Be sure to scrape plating.

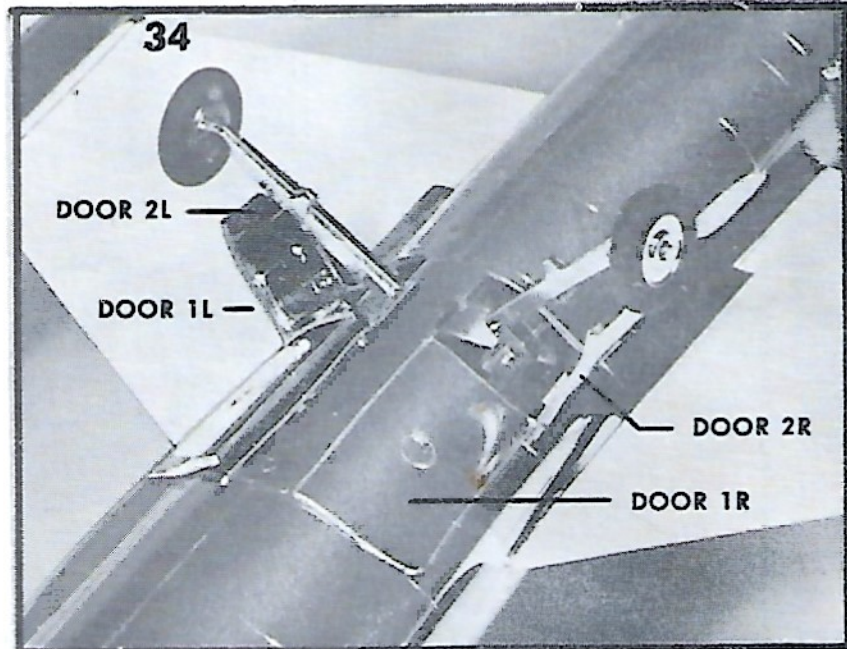

Cement doors 1L, 1R, 2L and 2R into position as shown.

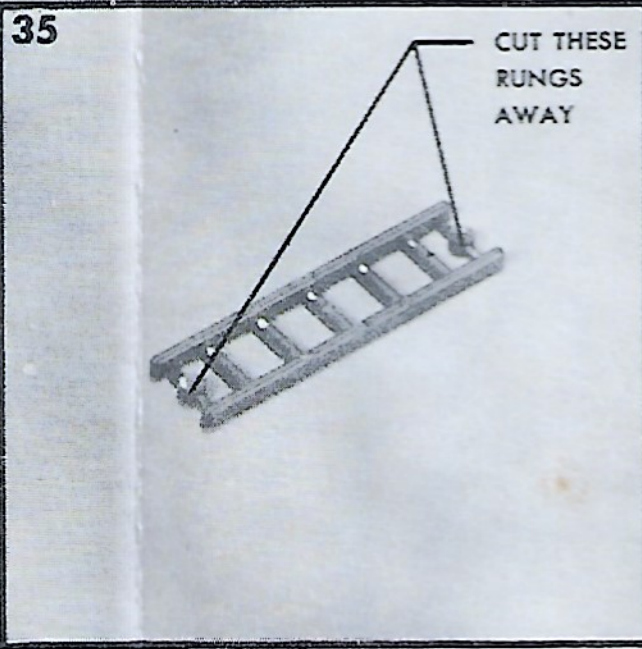

Cut the end rungs from the ladder as indicated.

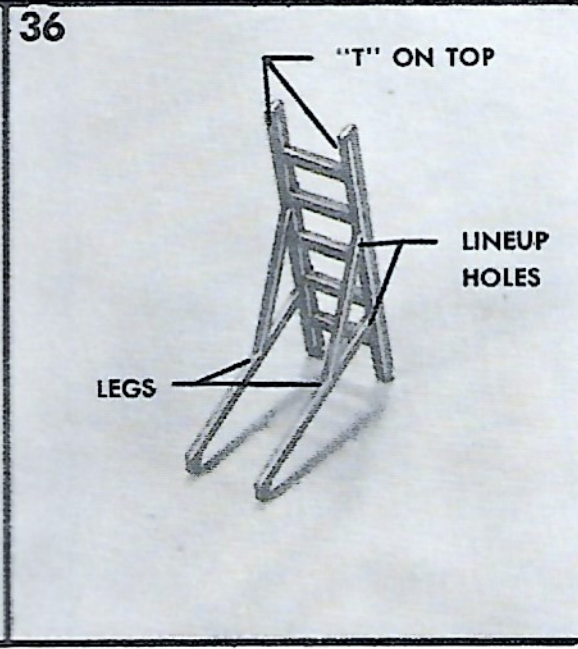

Glue the legs to the ladder. Note the position of the "T" marked on the ladder.

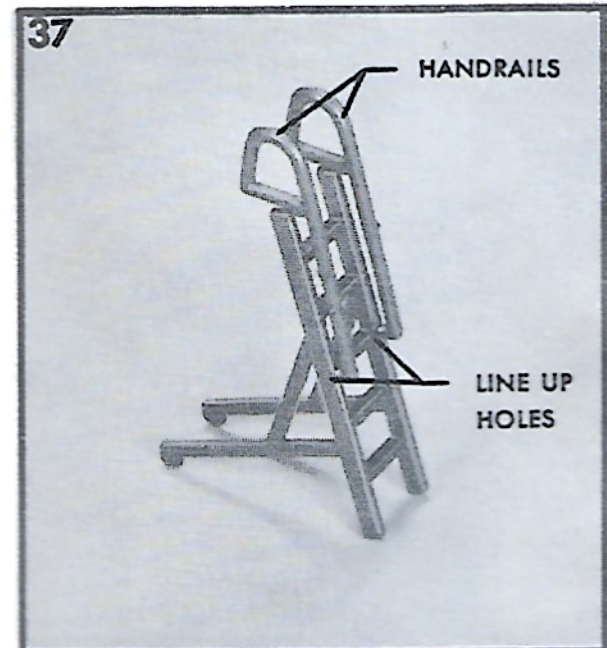

Glue the handrails into place as shown.



Glue the top platform into place. Paint the ladder orange and the top platform flat black. Display the ladder next to the Starfighter canopy and have the standing pilot nearby. This will show the size.

You have sufficient decals in your kit to produce the F-104 in the markings of one of three nations. The following page shows the correct color schemes and markings for the aircraft of your choice. Some collectors will want to build all three of the Starfighters shown as a means of illustrating the different ways one type of aircraft can be marked.

Did you like your F-104 kit? What other models would you like to see in the Authenti-Plate Custom Collector's Series? Write to:

CAPTAIN HAWK
Hawk Model Company
4600 N. Olcott
Chicago 31, Illinois

UNITED STATES AIR FORCE

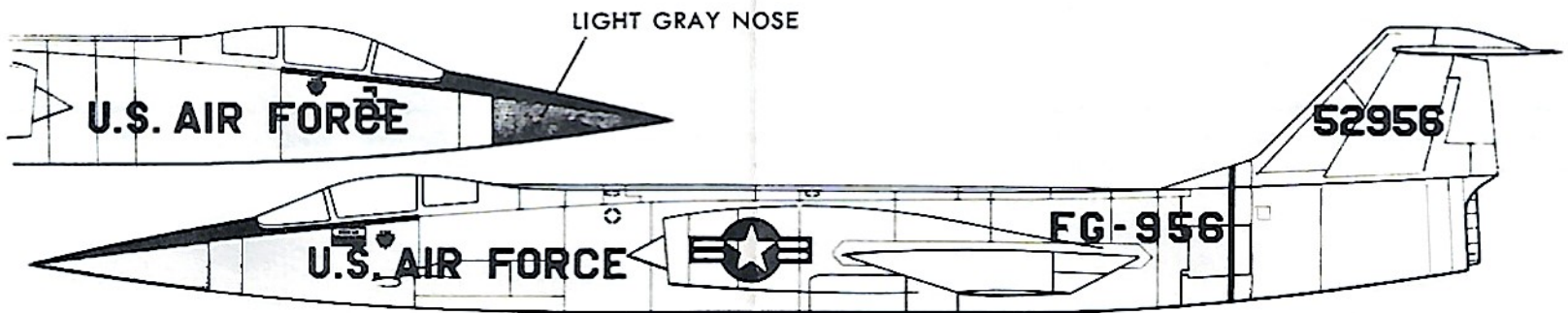
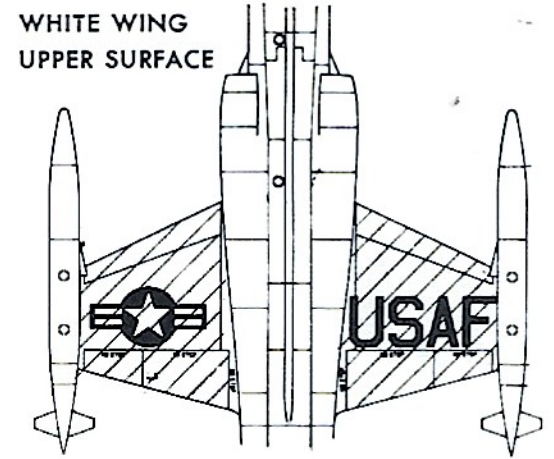
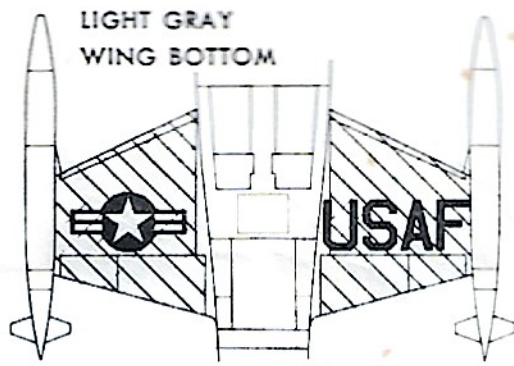

ROYAL CANADIAN AIR FORCE

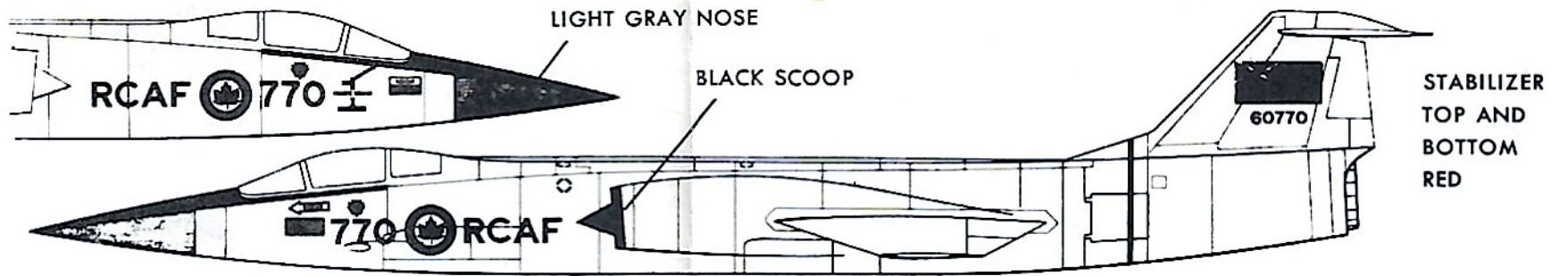
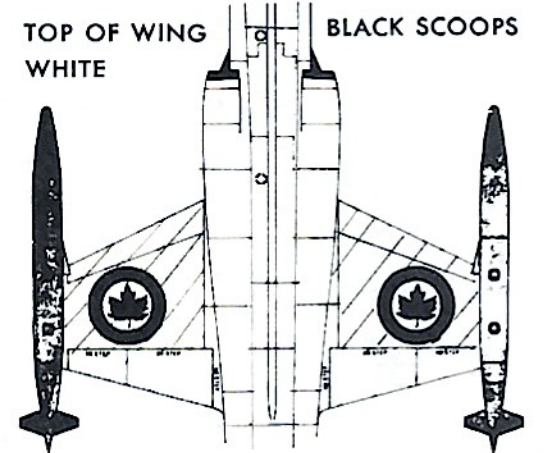
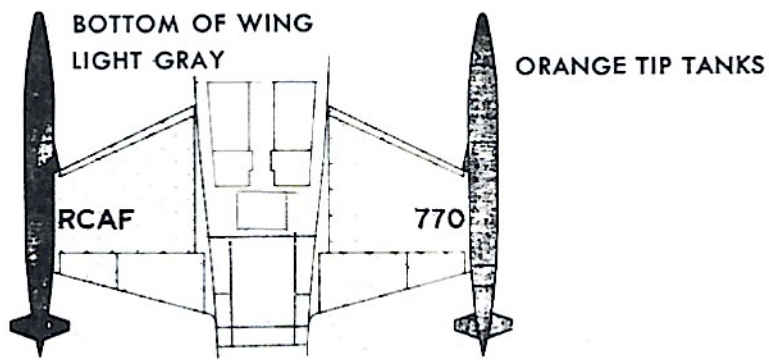

WEST GERMAN AIR FORCE

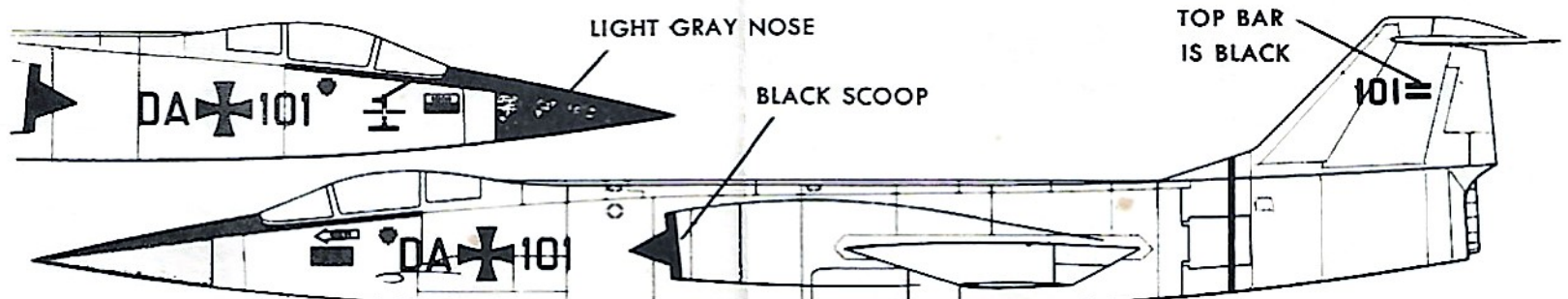
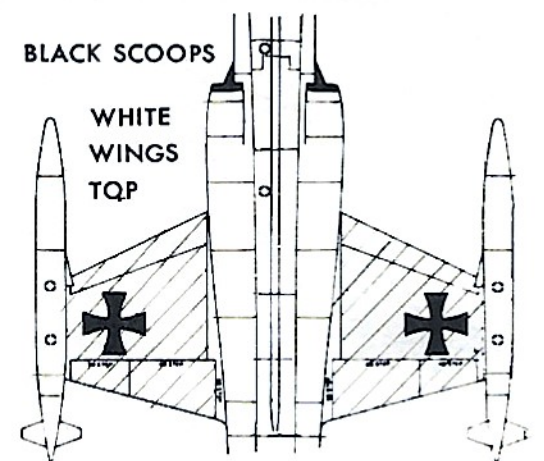
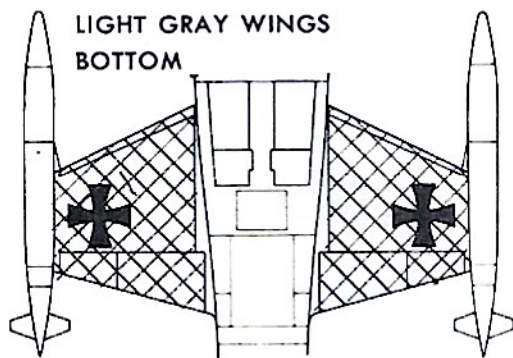

101



DA 101



RCAF

FG-956



U.S. AIR FORCE

U.S. AIR FORCE



RCAF



770

FG-956

60770



101



DA 101



USAF



U.S. AIR FORCE

U.S. AIR FORCE



52956

USAF

USAF

52956