

AMT
LIMITED EDITION

JUST WIN, BABY!



VF-31 SUNSET

F-14D LIMITED EDITION

F-14D VF-31 雄猫中队“日落”告别飞行限量版

1/72 SCALE **S7203**

注意事項 CAUTION 組み立てのご注意

- (1) 勿于近火处使用胶水或油漆, 并打开窗户保持空气流通。
- (2) 涂料的号码请参考本栏以下的说明。本品本身不包括胶水和涂料。
- (3) 自板件中取出部件时, 应用模型专用剪, 并用介刀或小锉除去多余胶料。
- (4) 各图形的含义可参考本栏以下说明。

- (1) When you use glue or paint, do not use near a open flame, and use in a well-ventilated room.
- (2) See below for the color list. Glue and paint are not included in the kit.
- (3) When you take parts off the runner frame, use the modeling scissors and trim excess plastic with a cutter or a file.
- (4) See below for the meaning of symbols.

- (1) 接着剂や塗料は火の近くで使わないで下さい、使用の際は換気をよくして下さい。
- (2) 塗料指定のは下記のとおりです、接着剂や塗料は入っていませんので別に求めて下さい。
- (3) 部品のランナーから切り離す時は模型用ハサミ等を使い、余分な部分はカッターやヤスリ等で仕上げて下さい。
- (4) 組立図のサインマークは下の説明を御覧下さい。

图形含义 CAUTION マーク



填平
FILL HOLE
穴を埋めて下さい

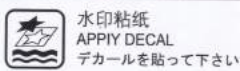

水印粘纸
APPLY DECAL
デカールを貼って下さい



切除
CUT OFF
切り取って下さい

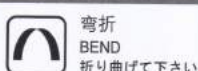

弯折
BEND
折り曲げて下さい

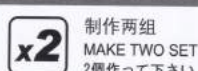

制作两组
MAKE TWO SET
2個作って下さい

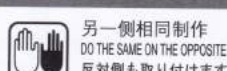

另一側相同制作
DO THE SAME ON THE OPPOSITE
反対側も取り付けます



胶水
CEMENT
接着して下さい



钻孔
OPEN HOLE
穴を開けて下さい

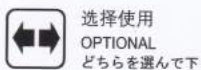

选择使用
OPTIONAL
どちらを選んで下さい



不用胶水
NO CEMENT
接着しないで下さい

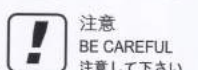

注意
BE CAREFUL
注意して下さい

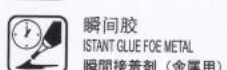

瞬间胶
INSTANT GLUE FOR METAL
瞬間接着剂 (金属用)

所使用工具 RECOMMENDED TOOLS 専用工具

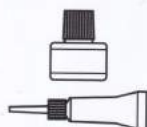

塑胶件用模型胶水
Cement
プラスチック用接着剂

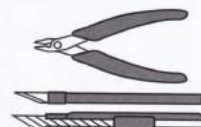

模型用剪钳
Side cutters
模型用ニッパー



模型用镊子
Tweezers
ピンセット



模型用瞬间胶水
Instant Cement
瞬間接着剂

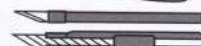

模型用刻刀
Modeling knife
模型用ナイフ



模型用锉刀
Diamond file
模型用ヤスリ

水贴纸使用说明 DECAL APPLICATION スライドマークの貼り方

- (1) 用模型剪刀或刻刀切下所需的图案部分。
- (2) 将水贴纸浸泡在温水中10秒左右取出放置于干水的干布上。
- (3) 手拿着水贴纸基的一角, 用模型镊子小心夹住浮起的水贴图案移至模型表面准确位置。
- (4) 用手指适当沾水均匀涂于水贴图案表面, 使其延展移动至精确位置。
- (5) 用柔软吸水的干布将水贴图案中的气泡向一边挤出, 使水贴在模型表面保持平整。

- (1) Cut off decal from sheet.
- (2) Dip the decal in tepid water for about 10 sec. and place on a clean cloth.
- (3) Hold the backing sheet edge and slide decal onto the model.
- (4) Move decal into position by wetting decal with finger.
- (5) Press decal down gently with a soft cloth until excess water and air bubbles are gone.

- (1) 貼りたいマークをハサミで切り抜きます。
- (2) マークをぬるま湯に10秒ほど浸してからタオル等の布の上に置きます。
- (3) 台紙のはしを手で持ち、貼るところにマークをスライドさせてモデルに移して下さい。
- (4) 指に少し水を付けてマークを濡らしてながら、正しい位置にずらしします。
- (5) 柔らかな布でマークの内側の気泡を押し出しながら、押しつけるようにして水分をとります。

蚀刻片使用说明 PHOTO-ETCHED PARTS エッチングパーツ

- (1) 使用蚀刻片专用剪刀或模型专用刻刀将蚀刻片零件切割下待用。
 - (2) 切割下的零件上有蚀刻片的残留连接点部分, 使用模型专用锉刀细心打磨干净。
 - (3) 蚀刻片部分在涂装之前必须使用专用的模型金属底漆打底。
- 注意事项: 蚀刻片很薄外延较为尖锐, 有刮伤手的可能, 在使用之时请务必小心。

- (1) Cut off photo-etched parts using a modeling knife.
 - (2) Carefully remove any excess using a file.
 - (3) Apply metal primer prior to painting.
- Attention, please: Extra care should be taken to avoid personal injury when handling photo-etched parts.

- (1) 切り離す時はカッターナイフを使用してパーツを切り離します。
 - (2) 切り出した時、部品に出張った部品が残っている場合は、ヤスリなどで丁寧に削り落とします。
 - (3) 塗装が必要なパーツは下地にメタルプライマーを吹き付けてから塗装します。
- ご注意: エッチングパーツは大変薄く、手などを切り恐れがあります。取扱いには十分注意して下さい。

涂装色表 PAINT REQUIRED カラー番号リスト

■ C|000 GSI CREOS Mr.COLOR ■ 00-000 ACRYLICOS VALLEJO ■ FS00000 联邦色号

C 2	A.MIG 0032	黑色	Black
C 8	A.MIG 212	银色	Silver
C 25	A.MIG 0277	深海灰	Dark Sea Gray
C 33	A.MIG 0046	消光黑	Flat Black
C 47		透明红	Clear Rad
C 50		透明蓝	Clear Blue
C 55	A.MIG 088	卡其色	Khaki
C 58		黄橙色	Orange Yellow

C 61	A.MIG 0046	消铁色	Burnt Iron
C 304		橄榄褐	FS34087 Olive Drab FS34087
C 305		灰色	FS36118 Gray FS36118
C 307	A.MIG 0208	灰色	FS36320 Gray FS36320
C 308		灰色	FS36375 Gray FS36375
C 315		浅灰色	FS16440 Light Gray FS16440
C 316	A.MIG 0047	白色	FS17875 White FS17875
C 317		灰色	FS36231 Gray FS36231

C 327	A.MIG 0049	红色	FS11136 Red FS11136
C 329	A.MIG 0048	黄色	FS13538 Yellow FS13538
C 337		灰蓝色	FS35237 Gray Blue FS35237

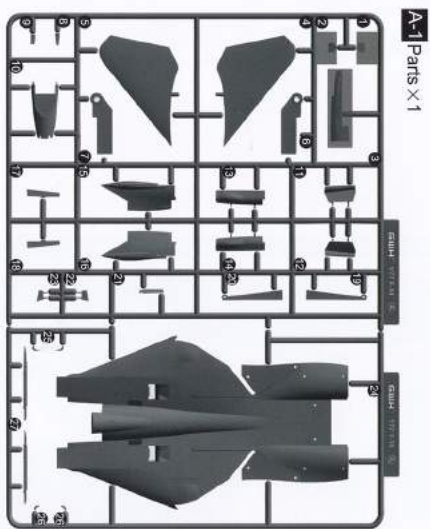

A-1 Parts X1

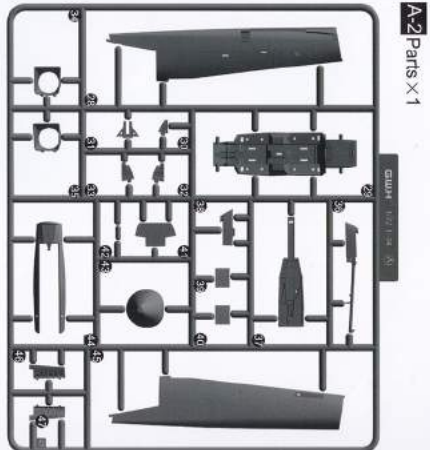

A-2 Parts X1

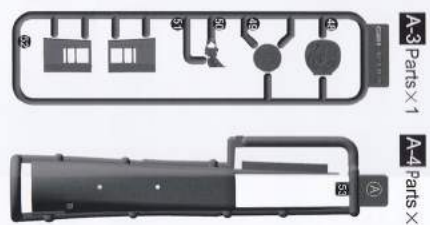

A-3 Parts X1



A-4 Parts X1

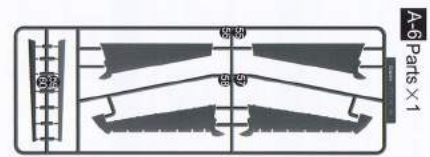

A-5 Parts X1

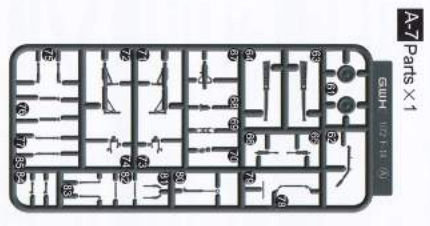

A-6 Parts X1



A-7 Parts X1



G Parts X1



C Parts X1



D Parts X2



L Parts X2

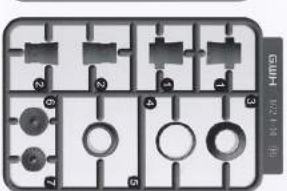

R Parts X2

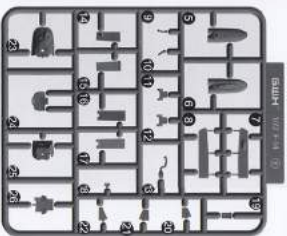

Y2 Parts X1

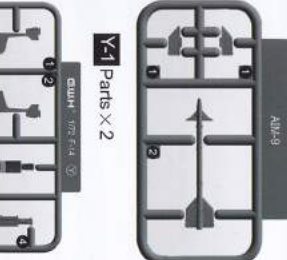

Y1 Parts X2



K Parts X1

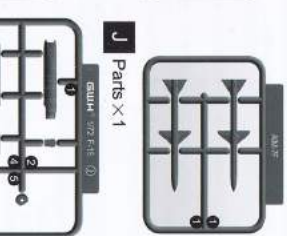

J Parts X1

T Parts X1

E Parts X1

H Parts X1

Q Parts X1

N Parts X1

V Parts X1

LAU-138 Parts X1

LAU-138

LAU-138

O Parts X2

AMM-9 Parts X2

AMM-9

AMM-7 Parts X1

AMM-7

阴影零件不使用
DO NOT USE THE
SHADOW PARTS

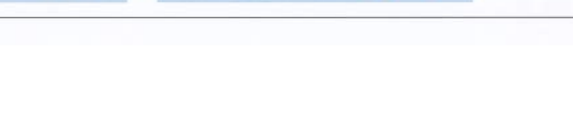
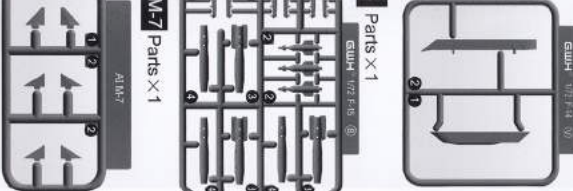
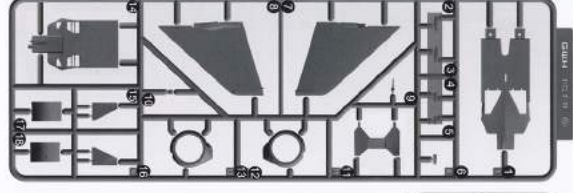
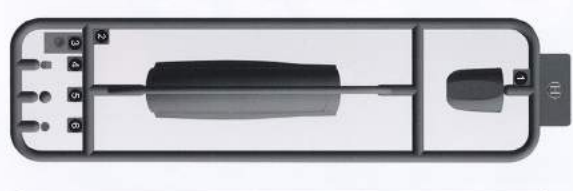
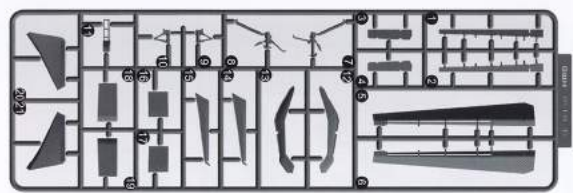
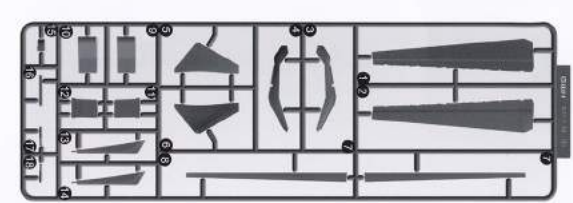

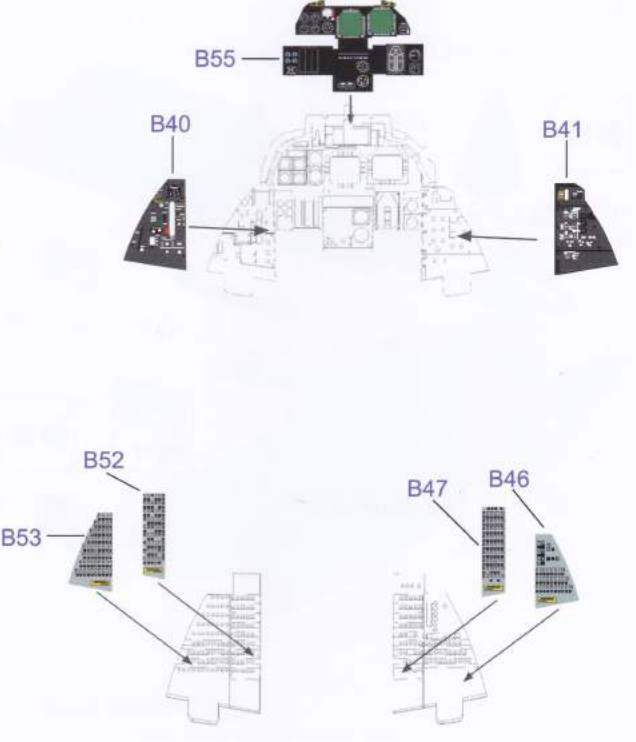
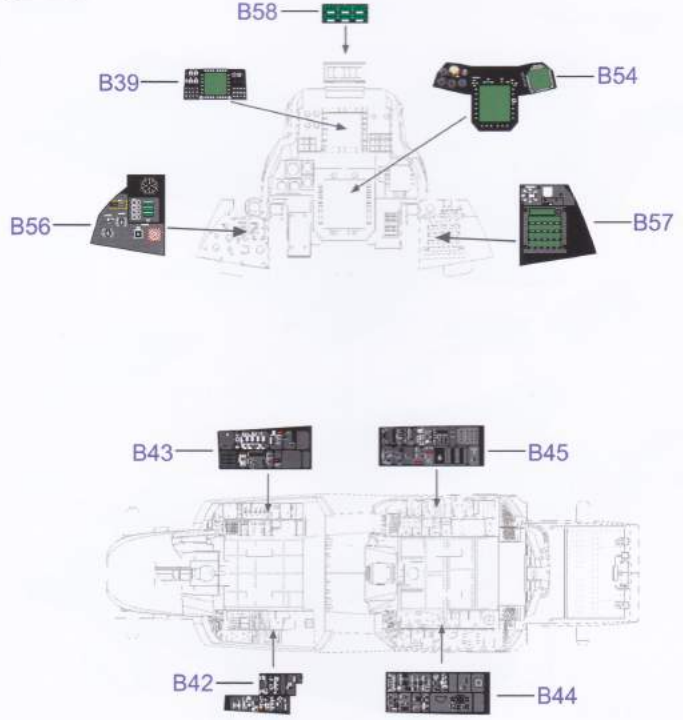
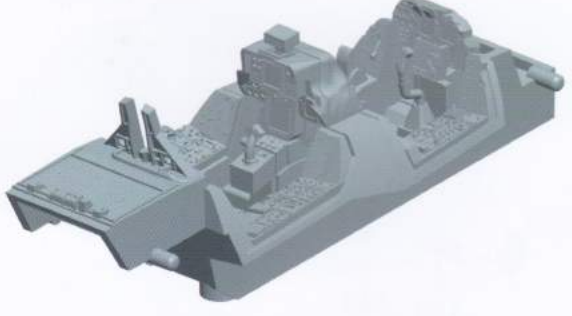
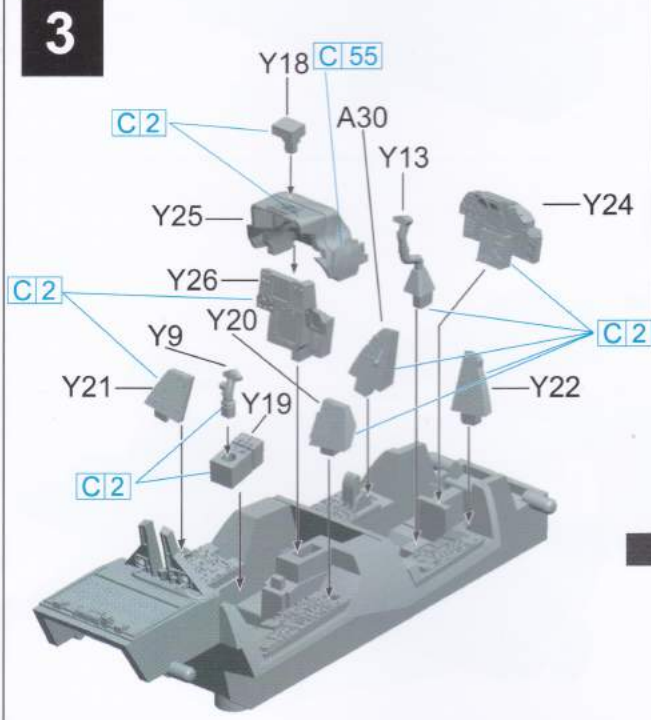
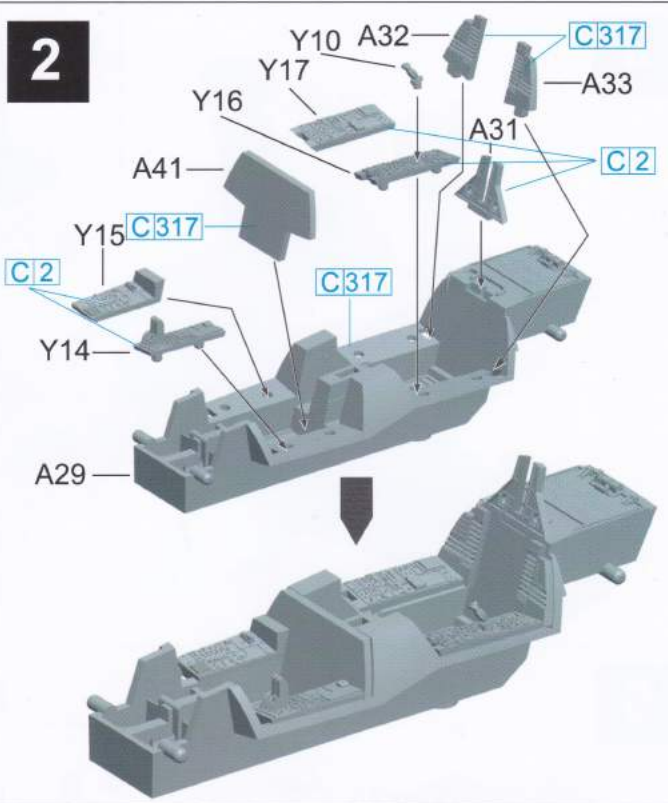
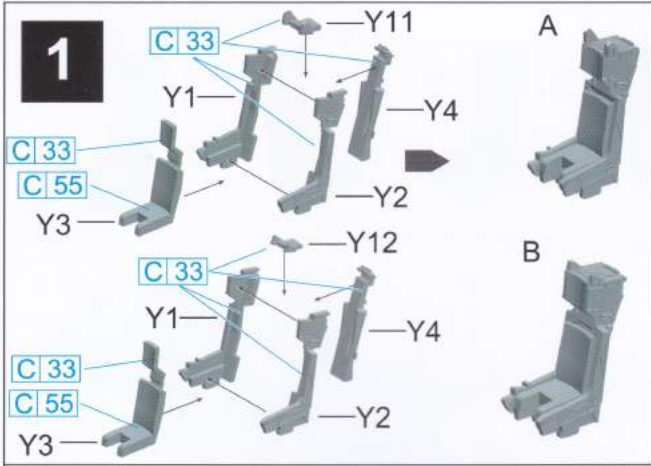

4

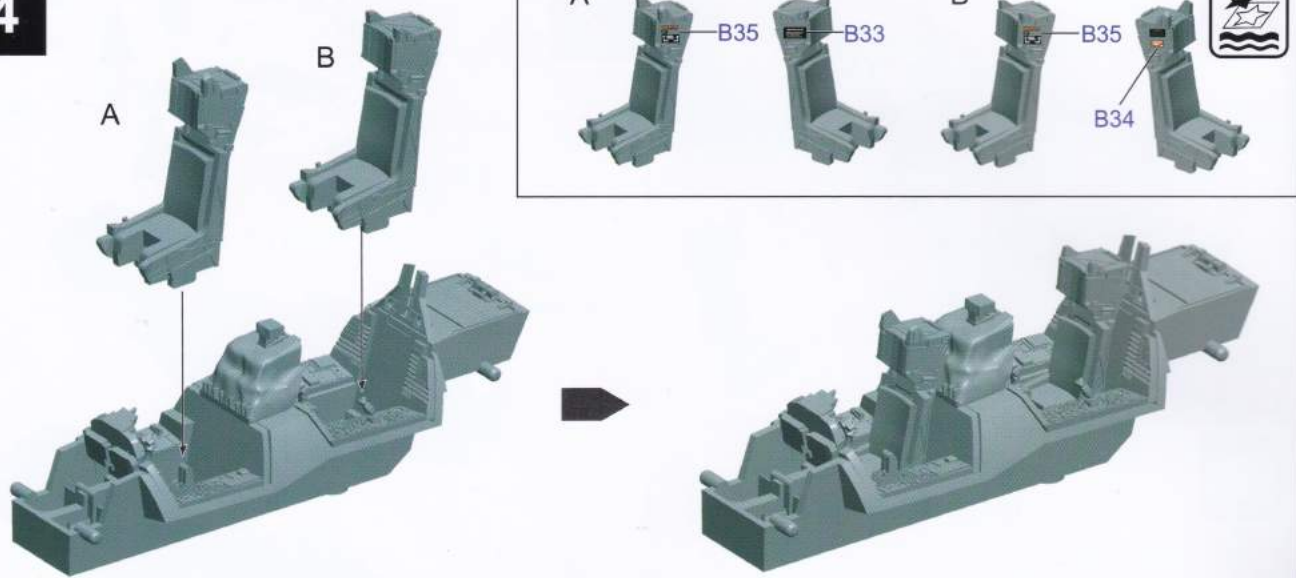

5

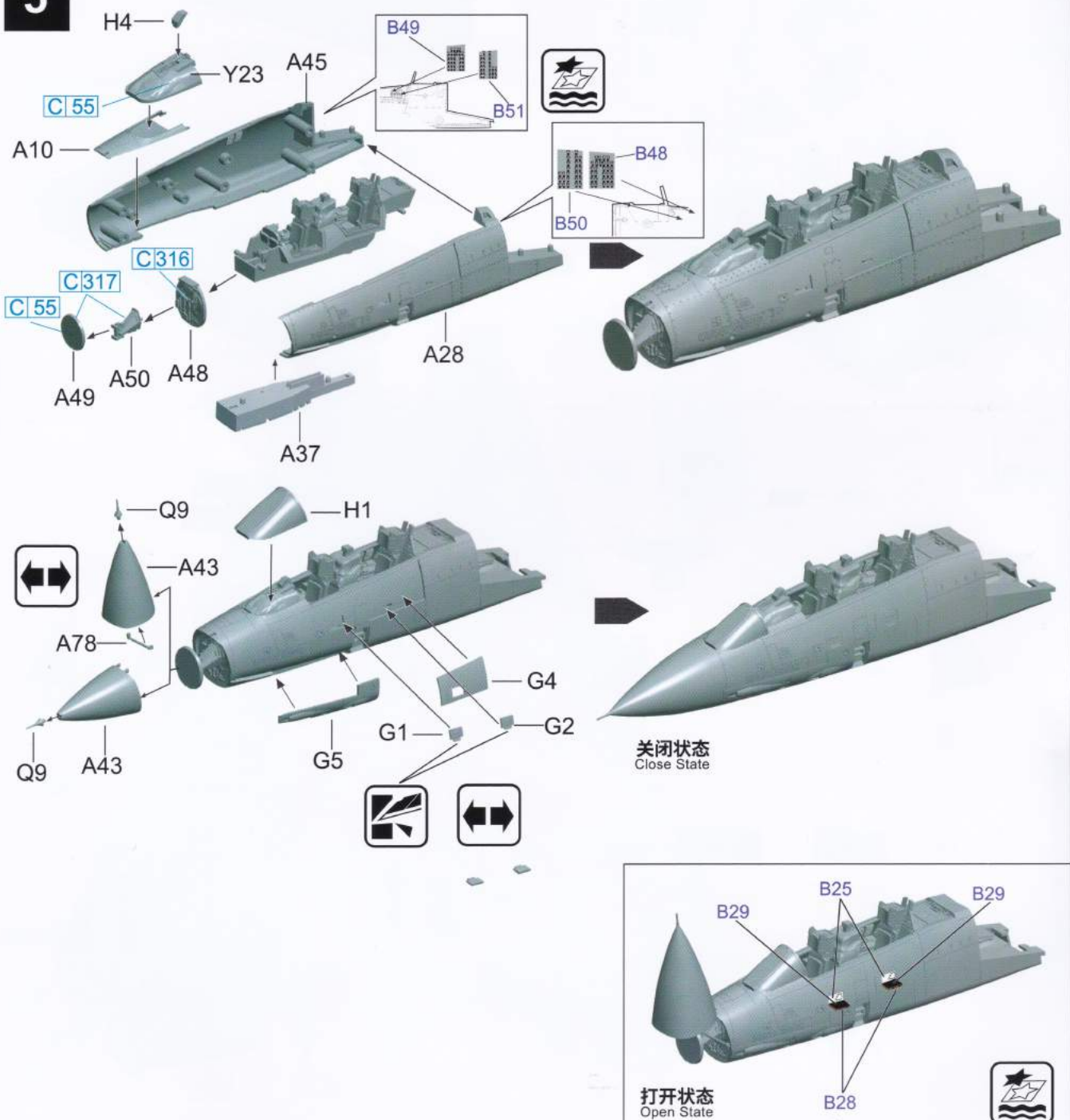

6

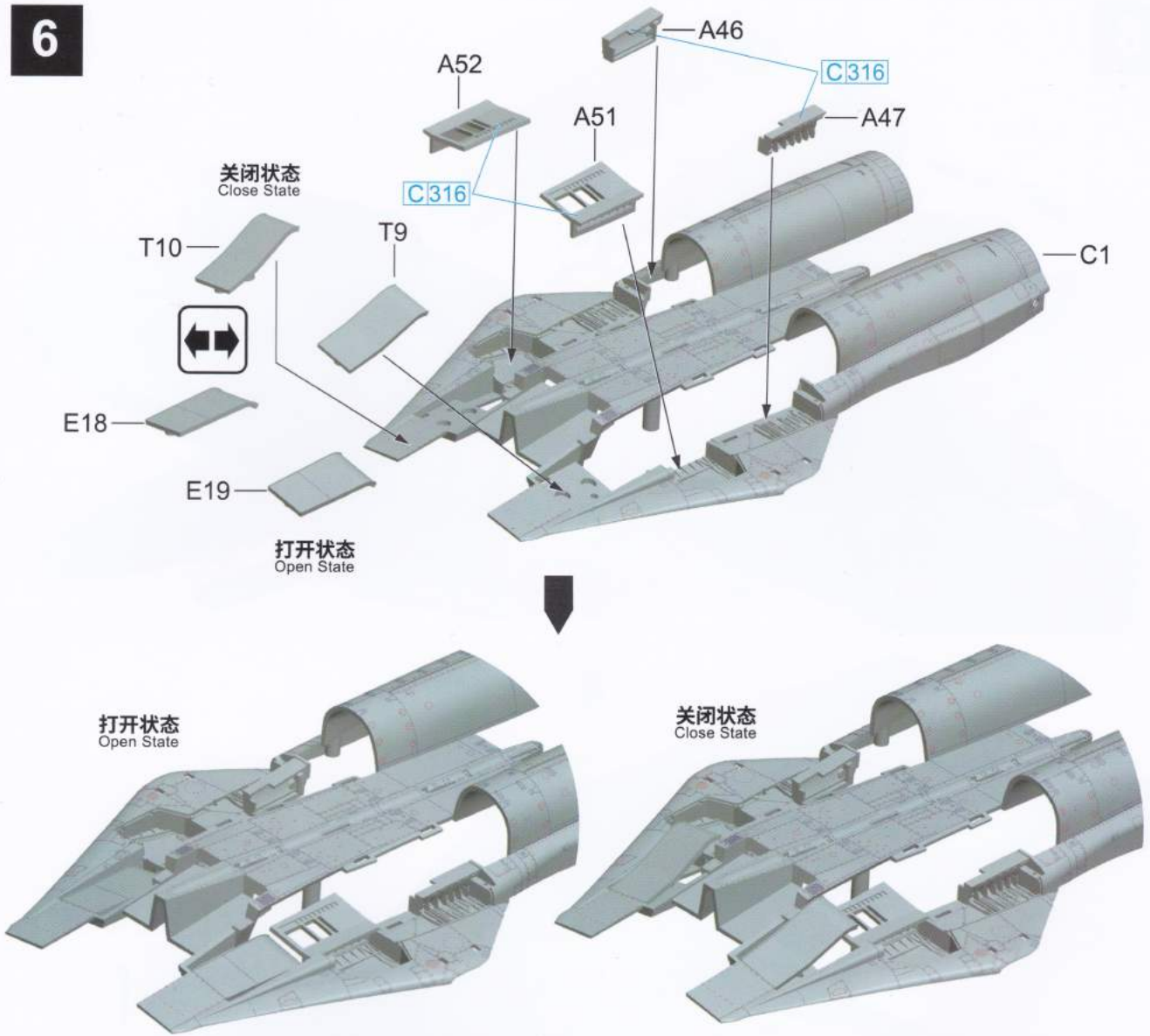

7

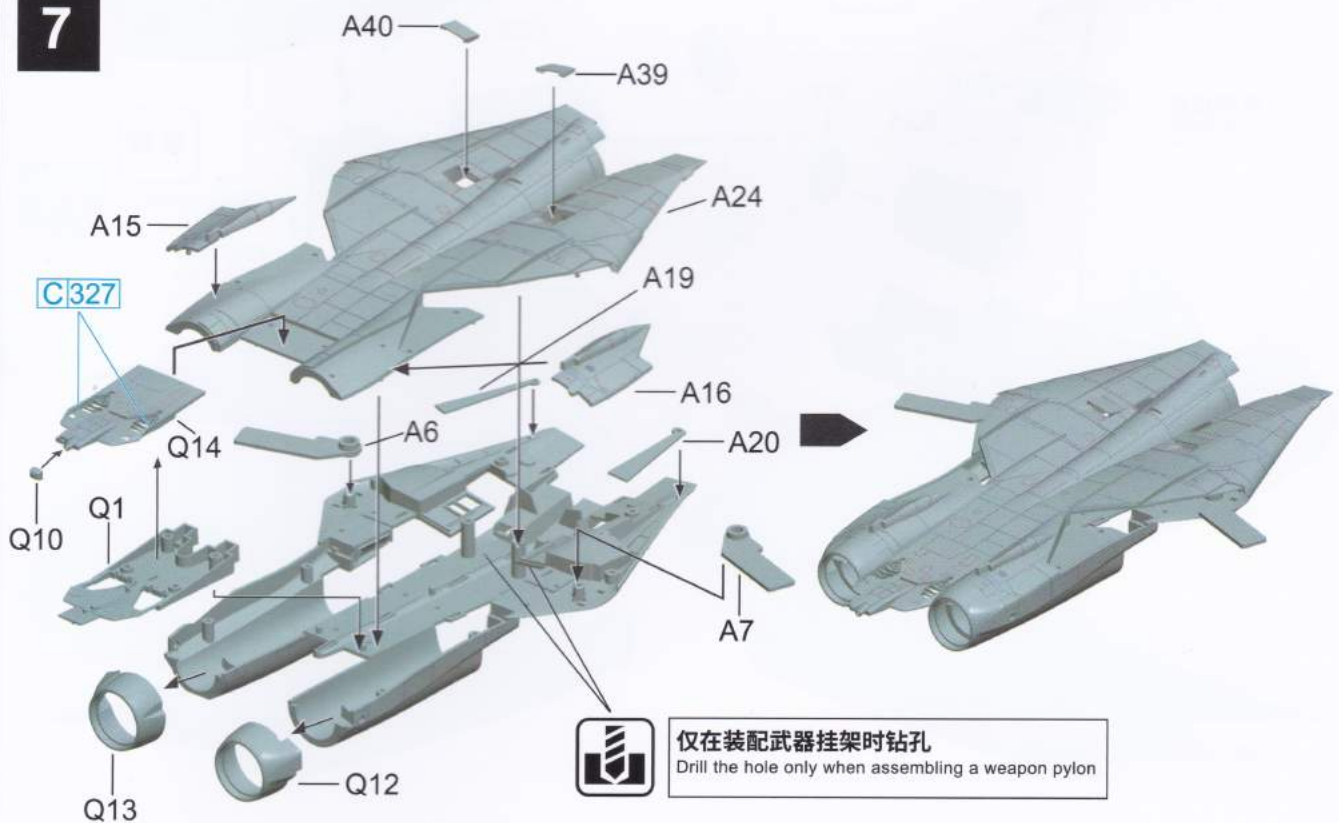

8

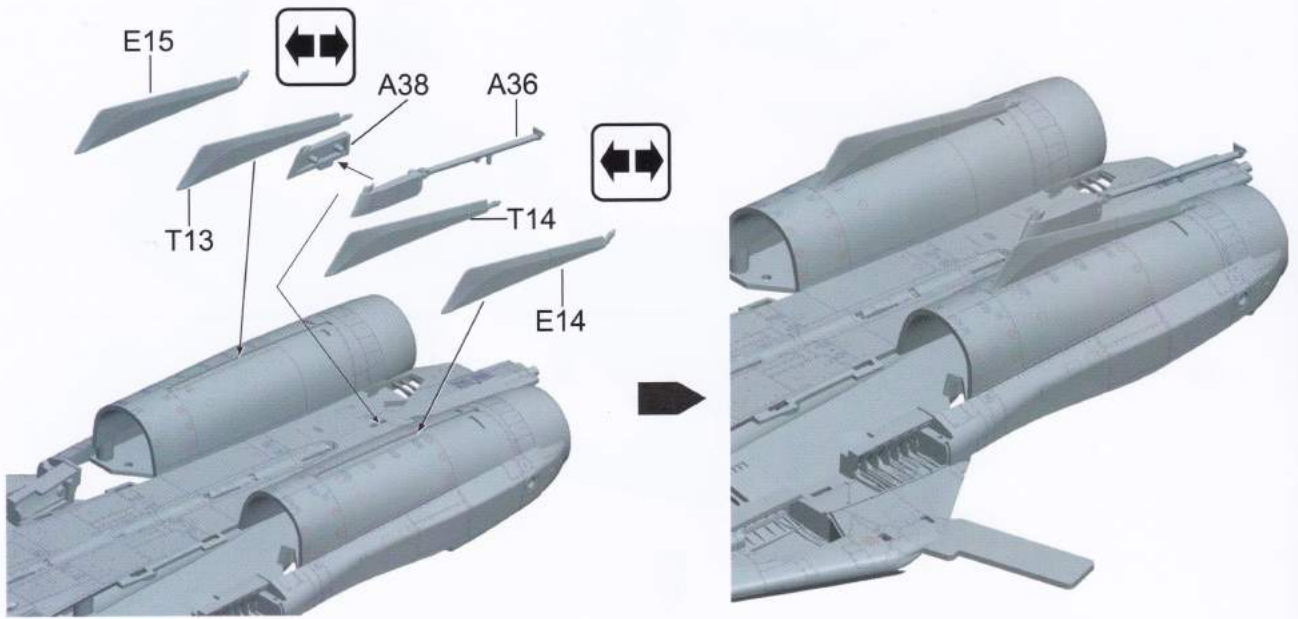

9

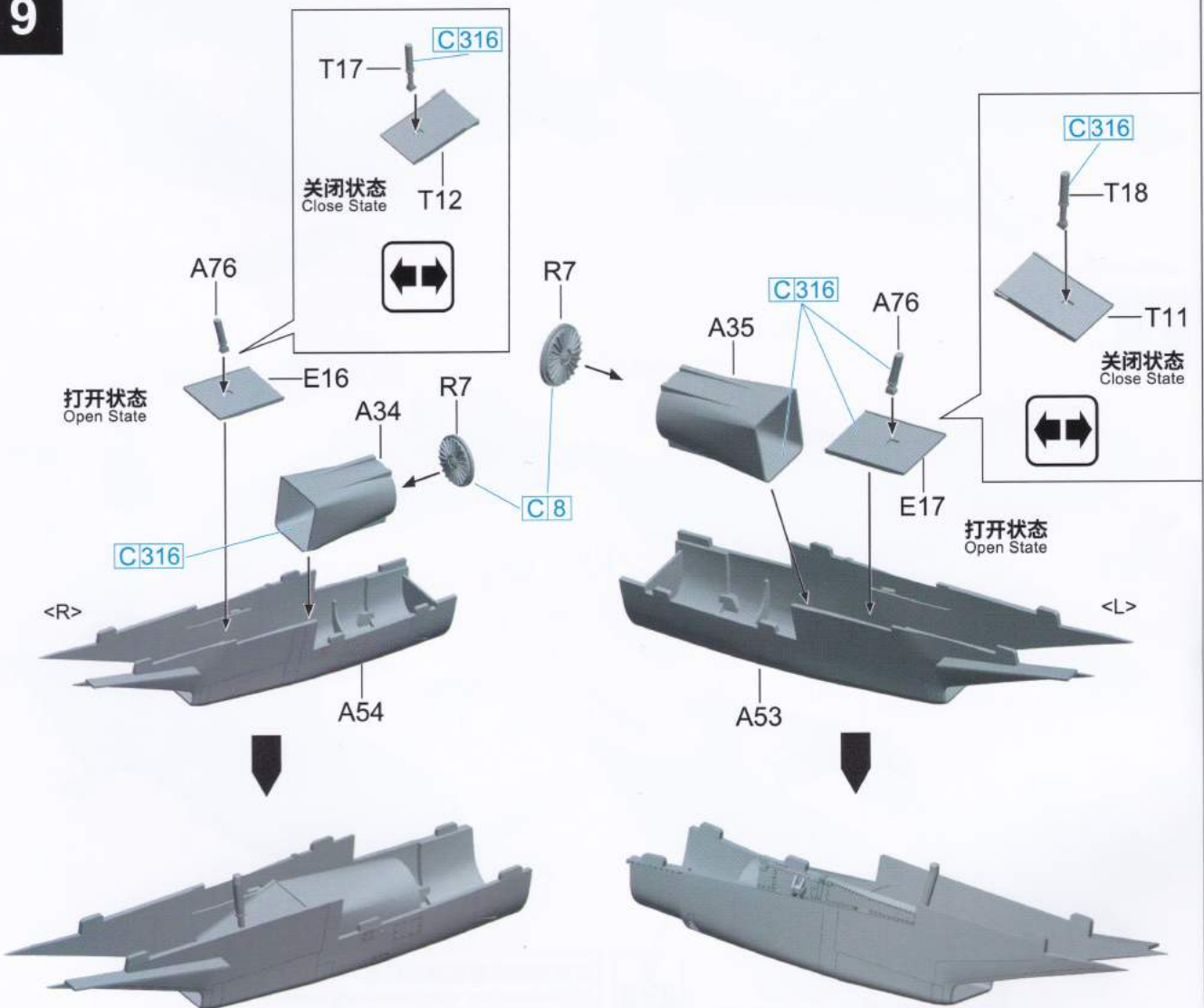

10



11

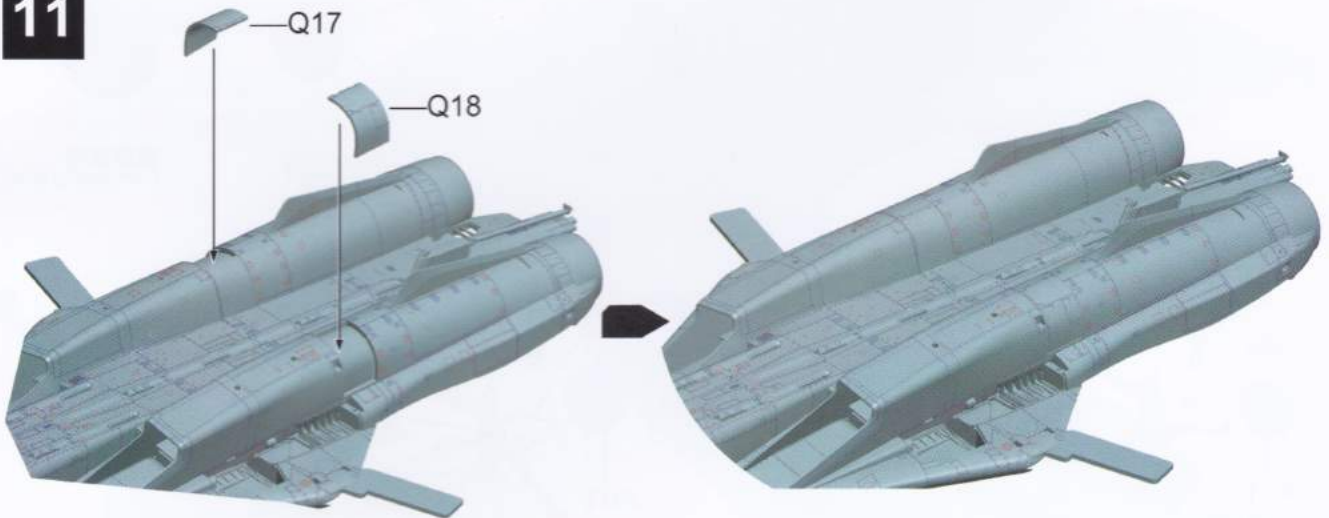

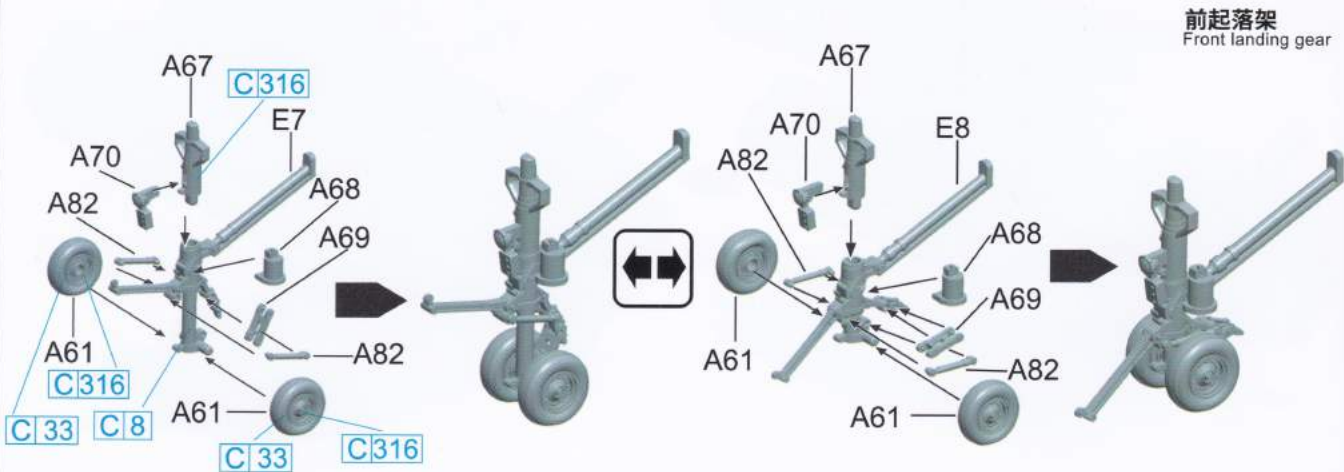
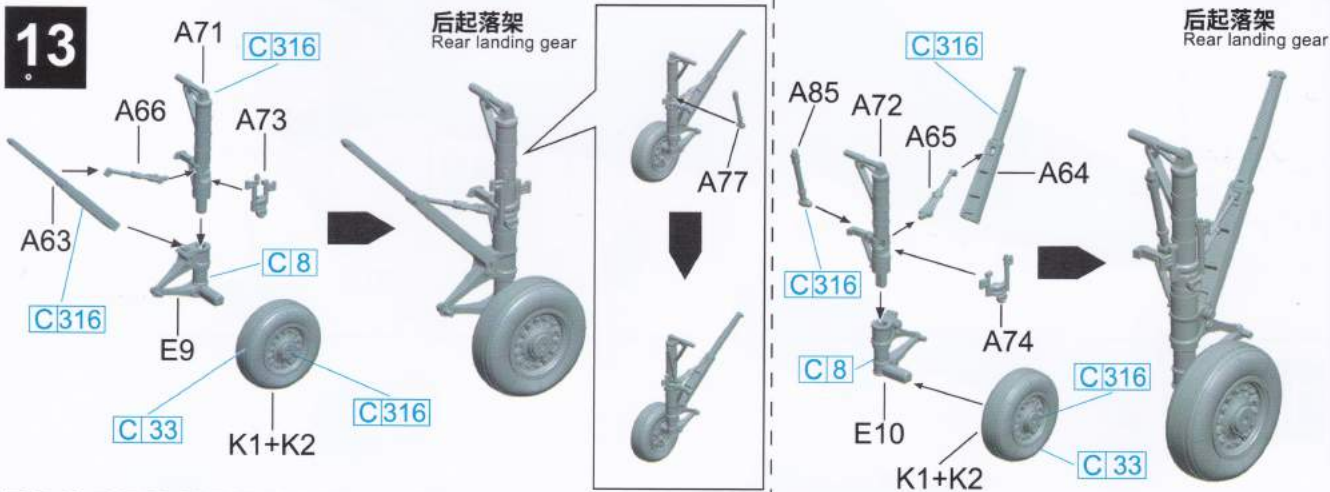
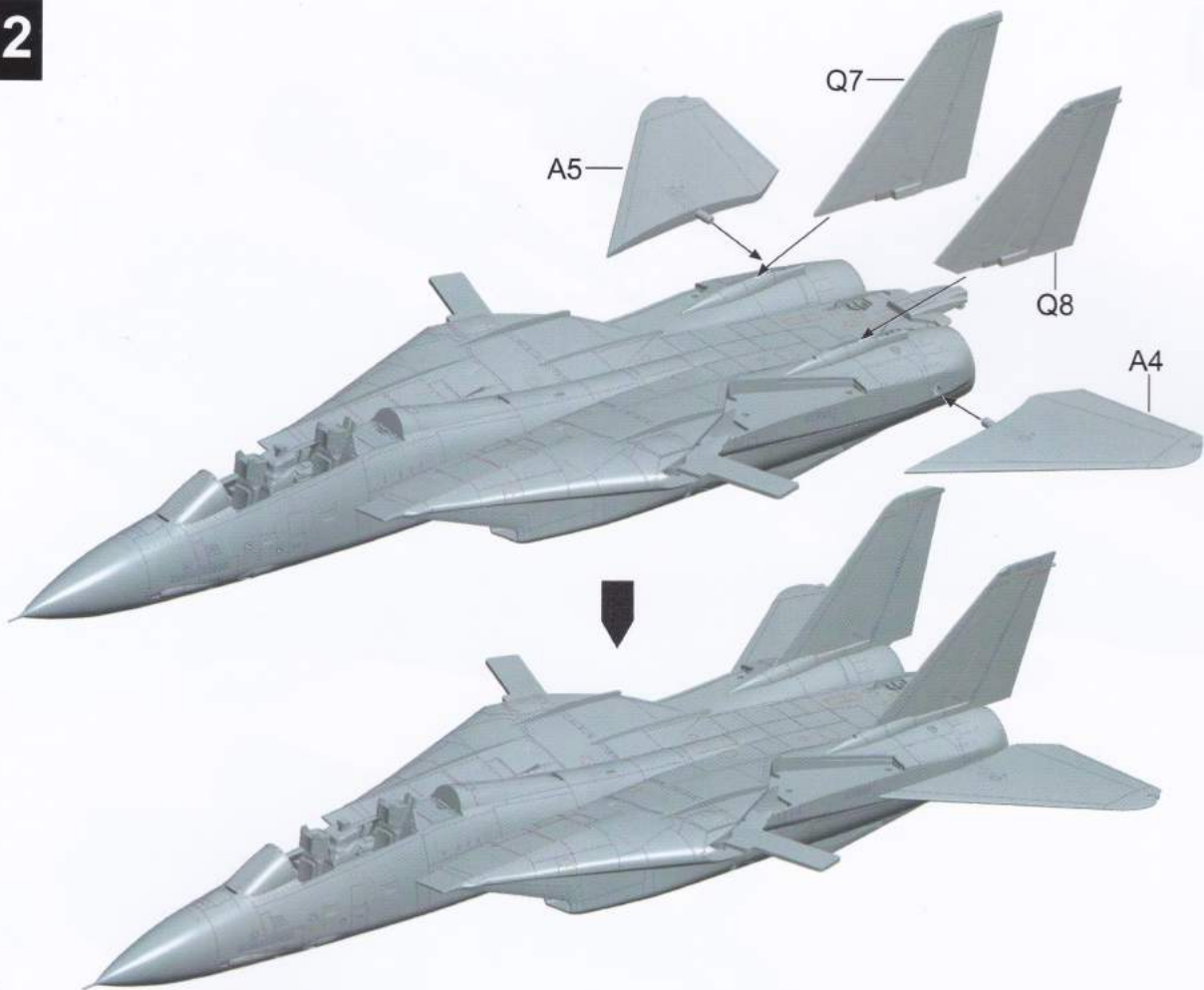

14

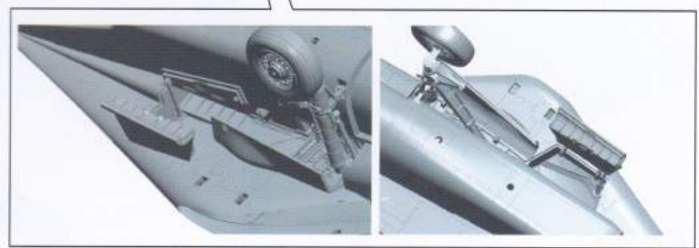
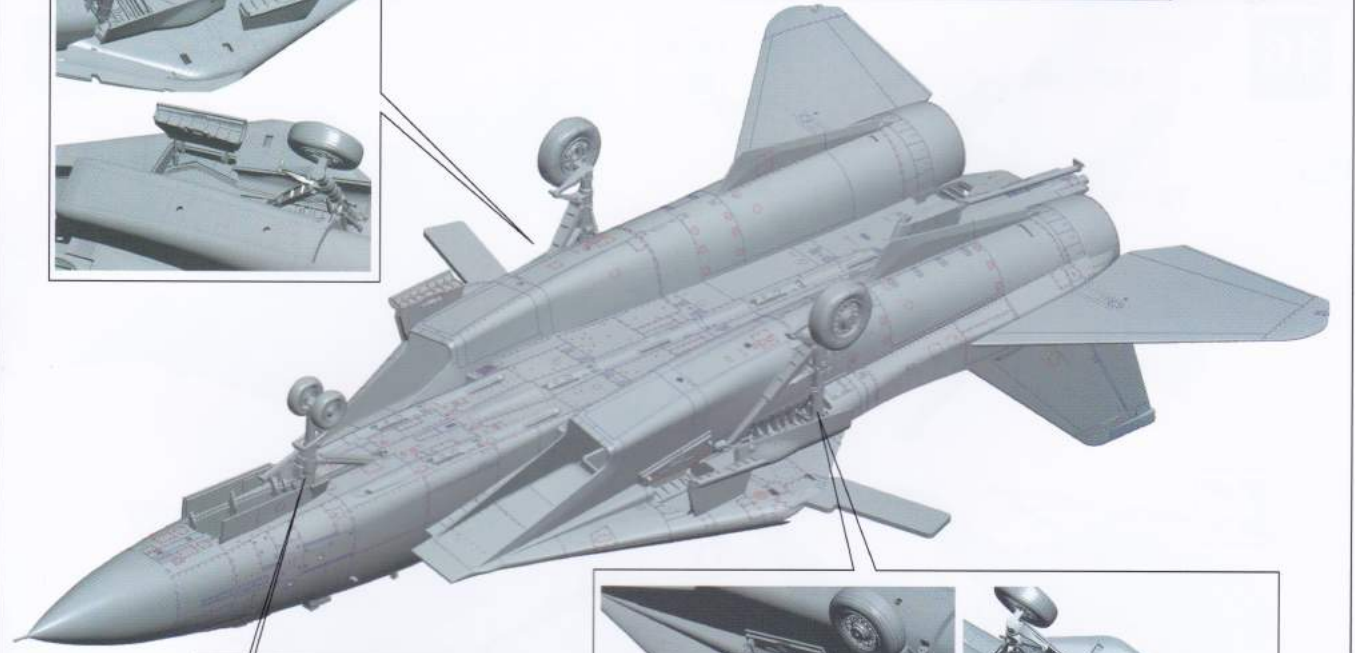
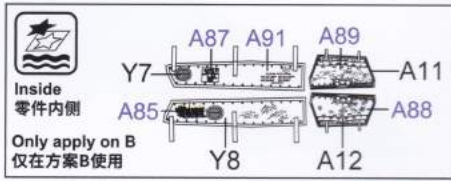
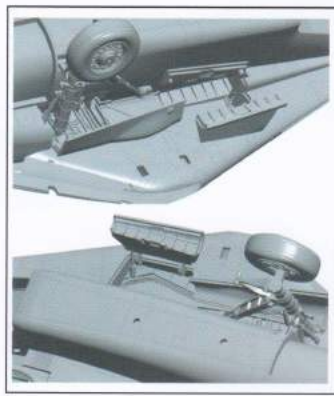
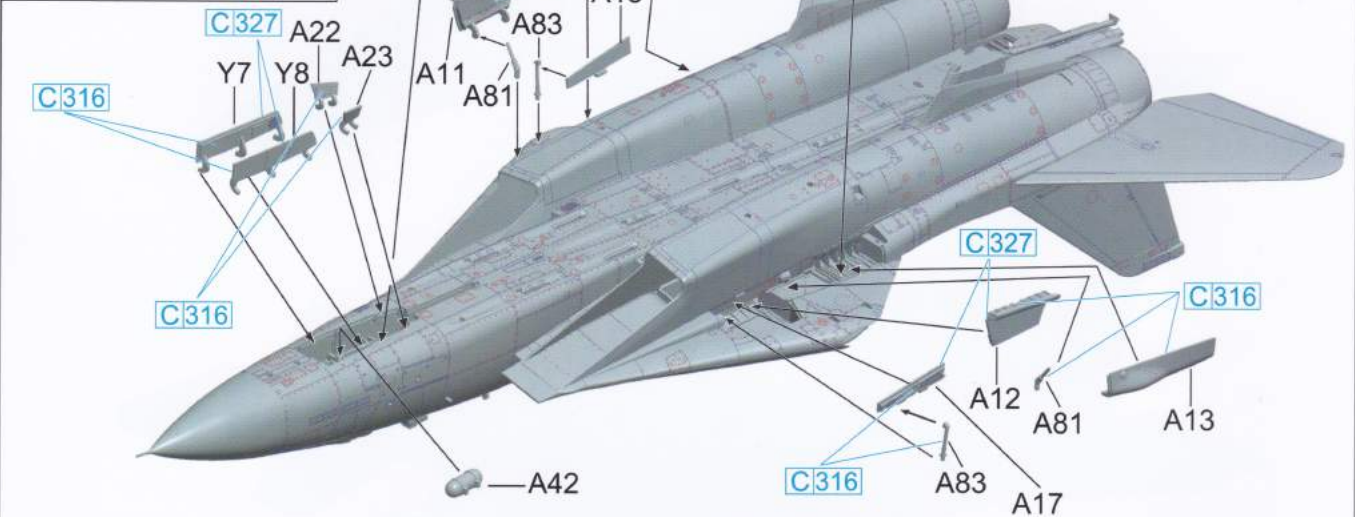

打开状态
Open State

15

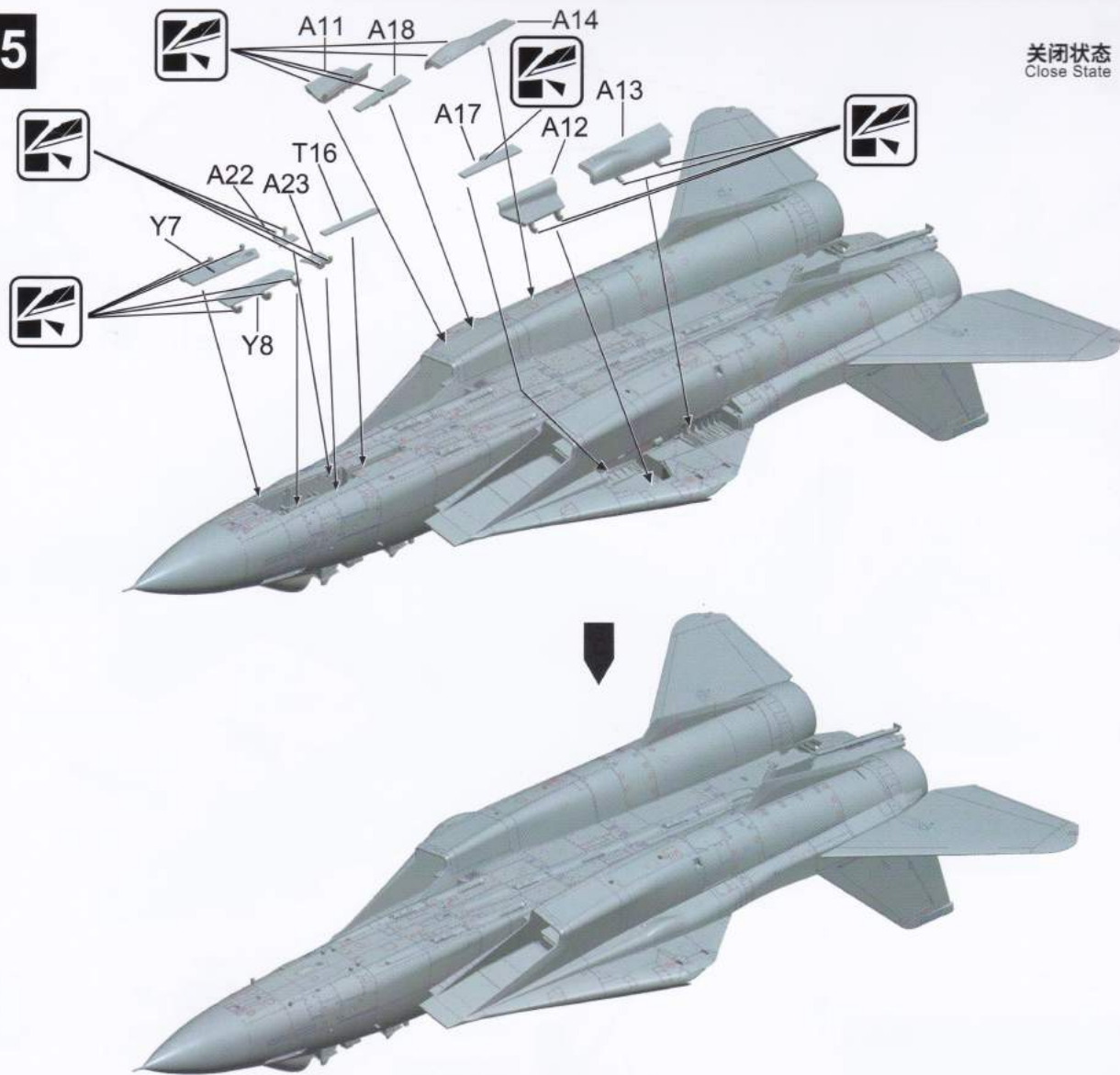

16

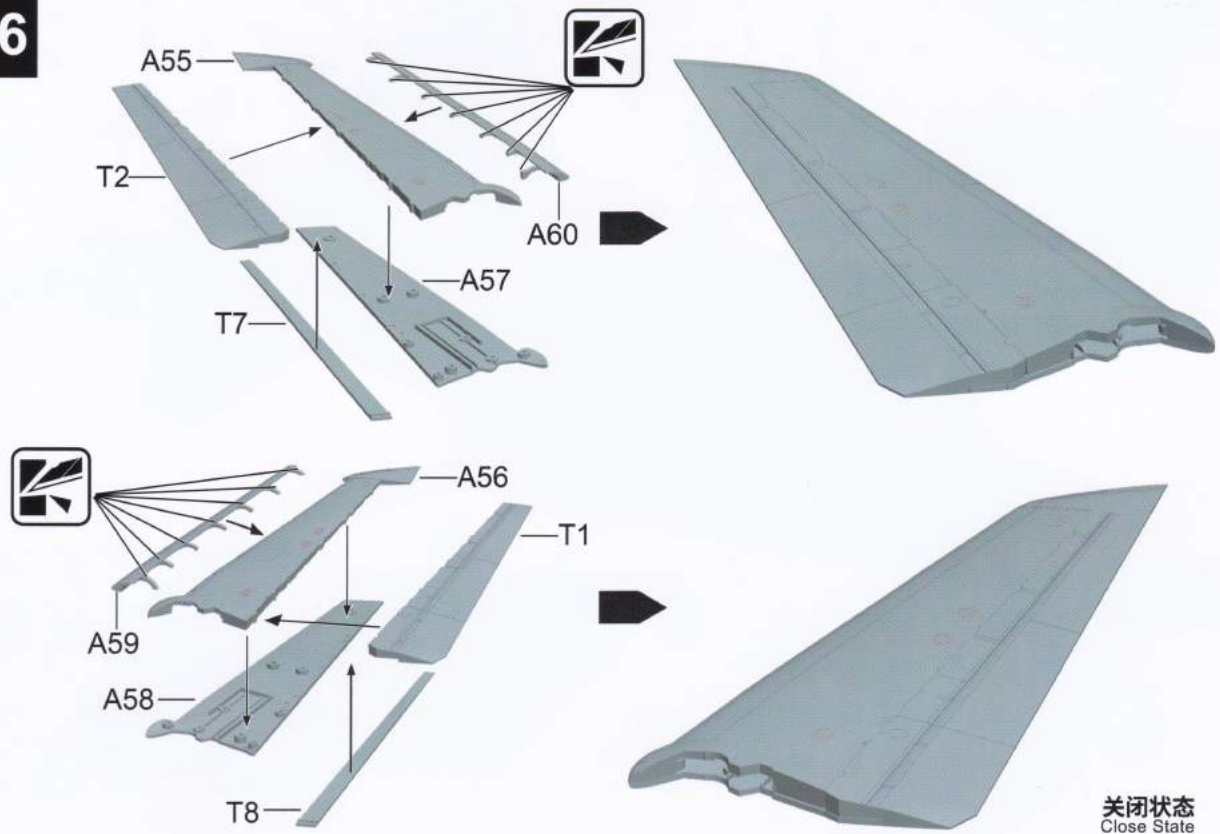

17



关闭状态
Close State

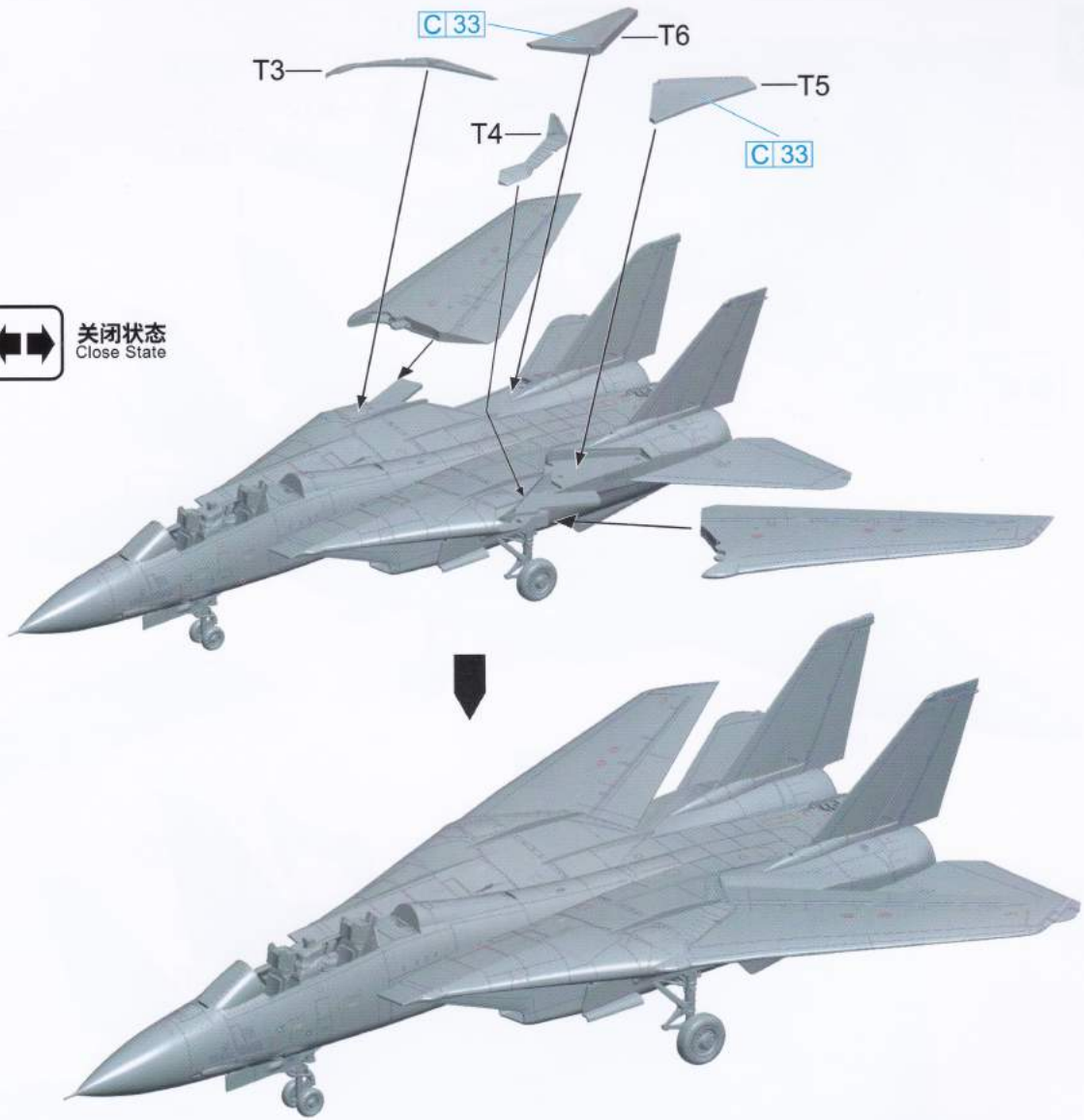

18

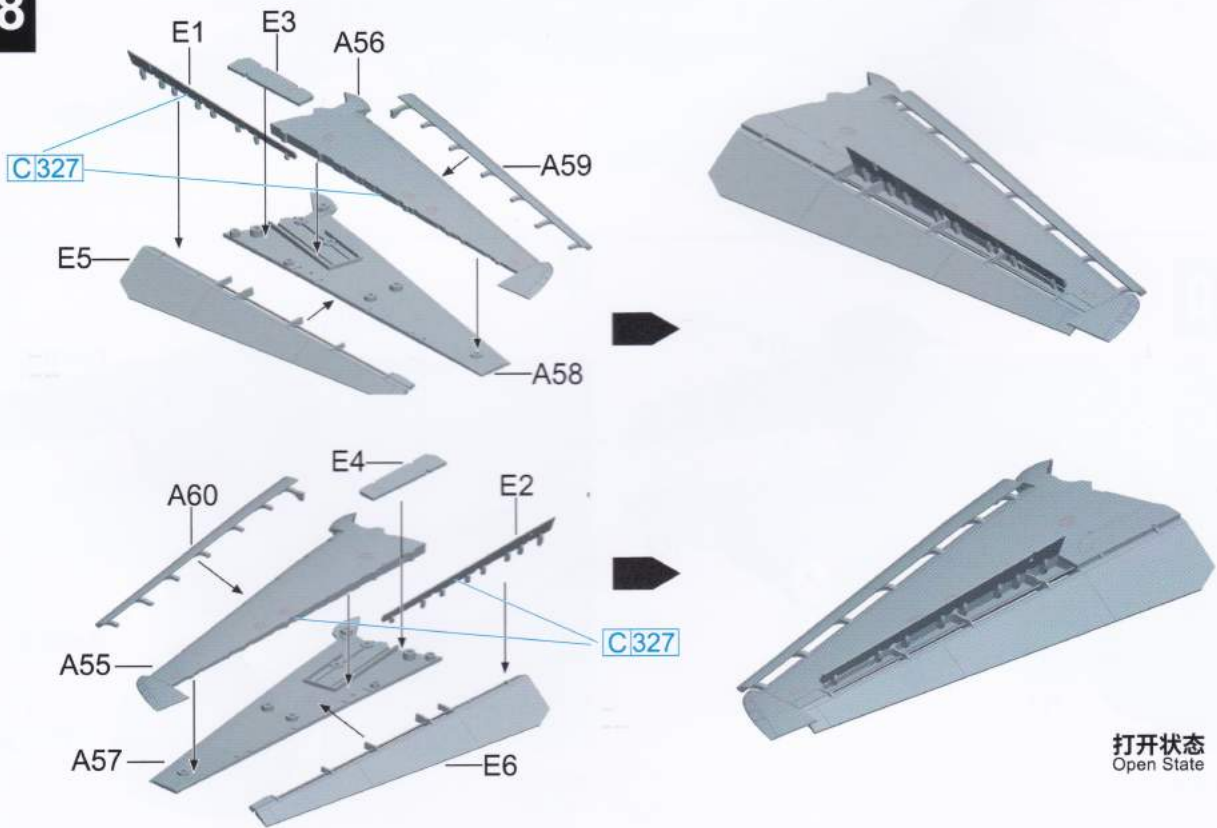

打开状态
Open State

19

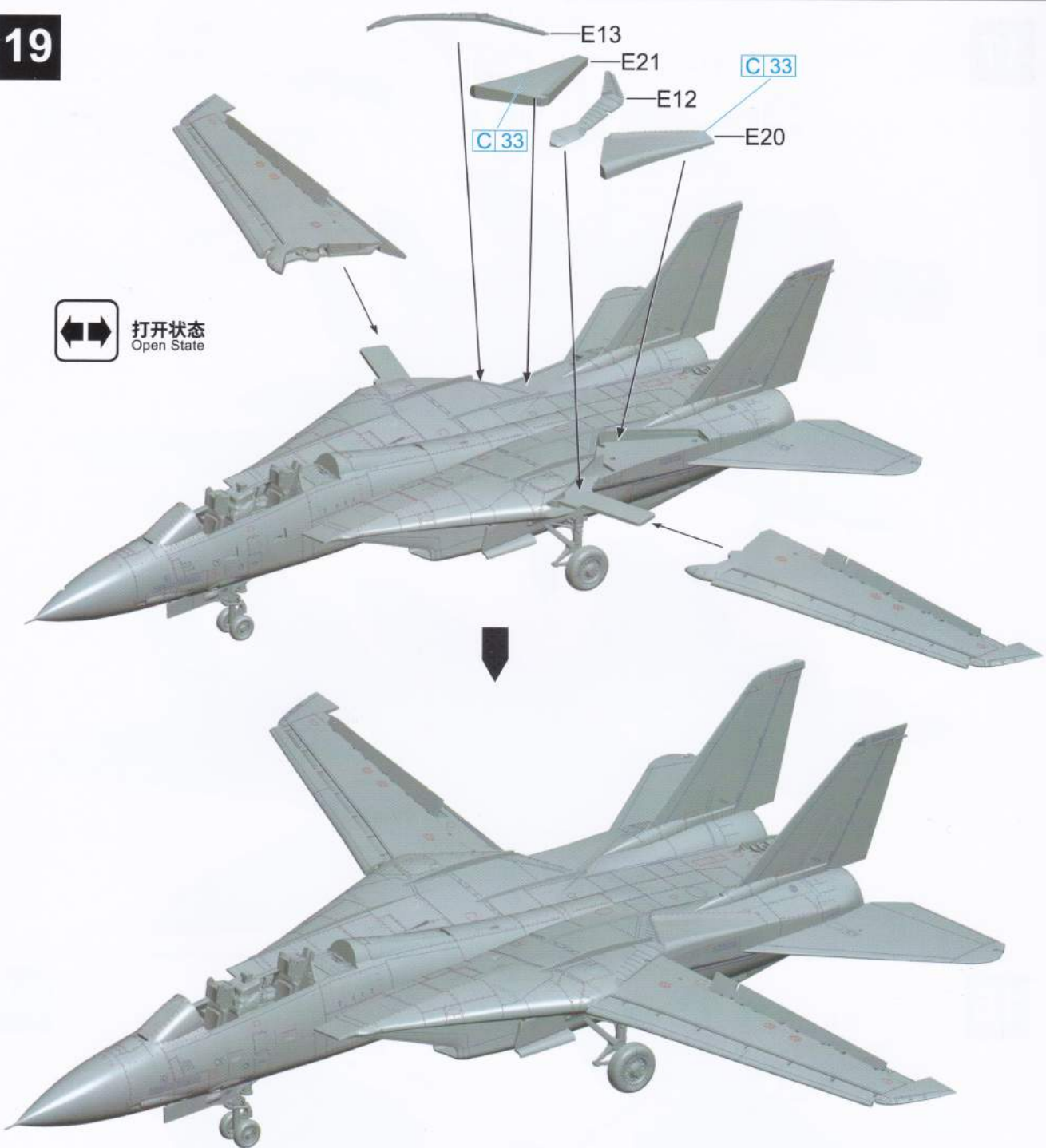

打开状态
Open State

20

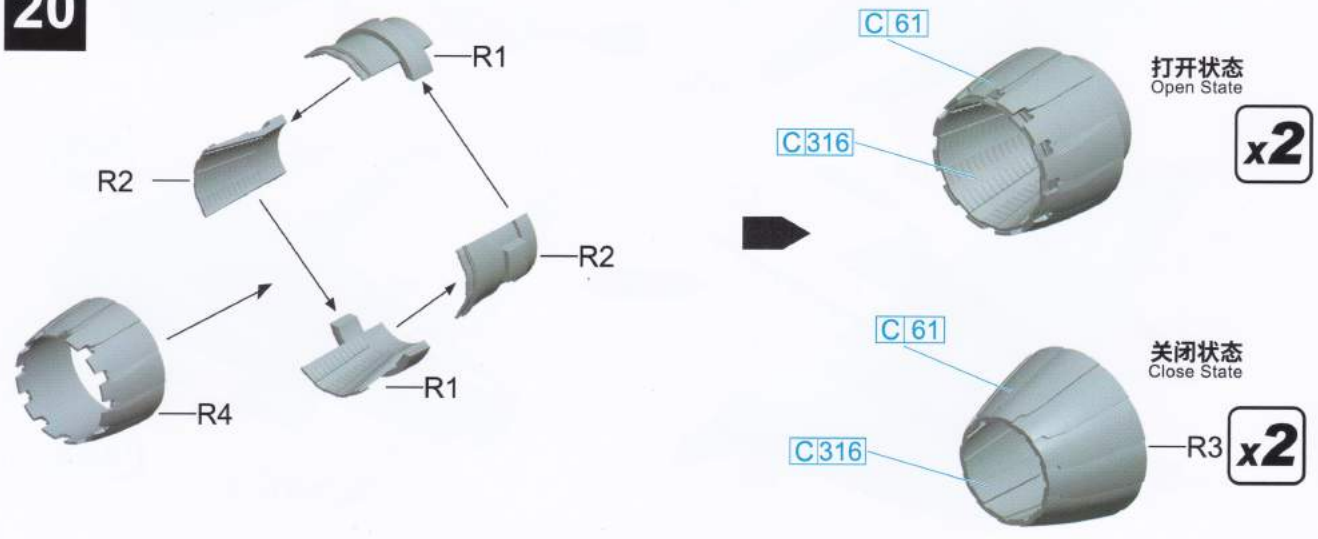

打开状态
Open State

x2

关闭状态
Close State

x2

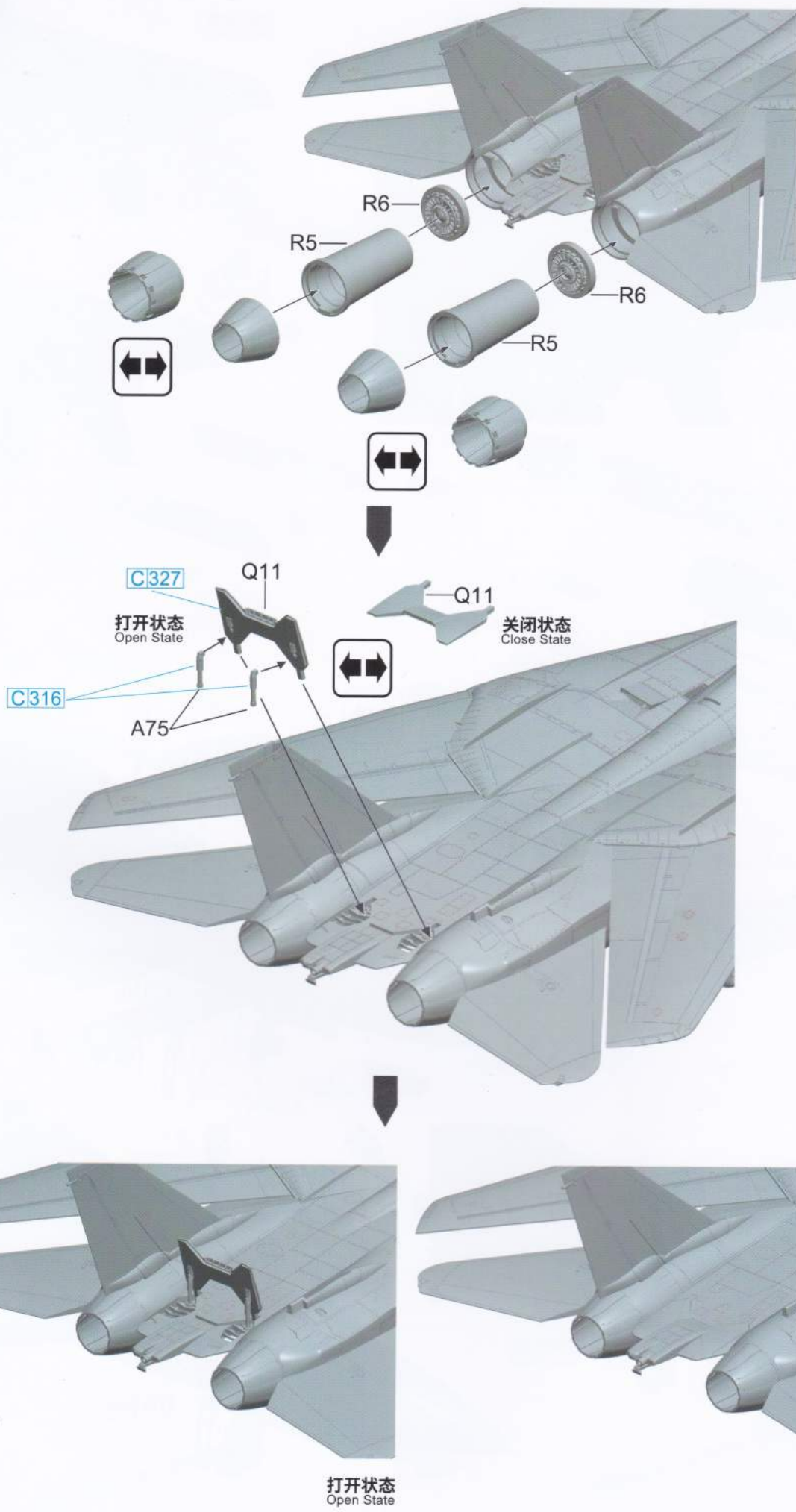

打开状态
Open State

关闭状态
Close State

22

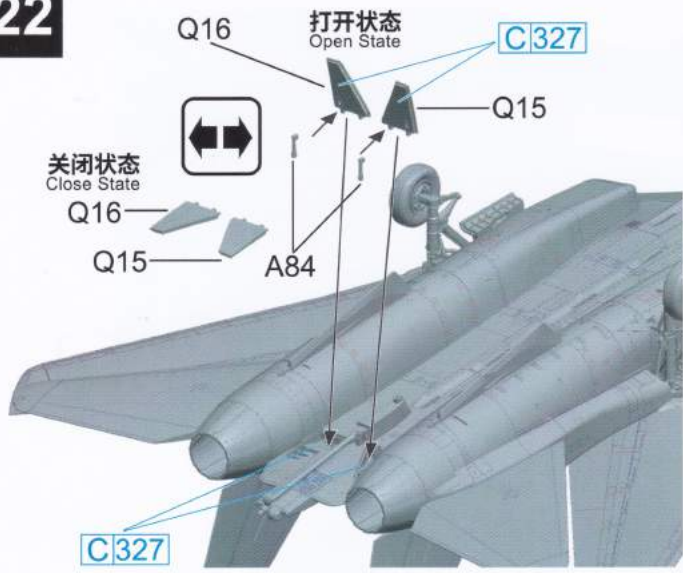

23

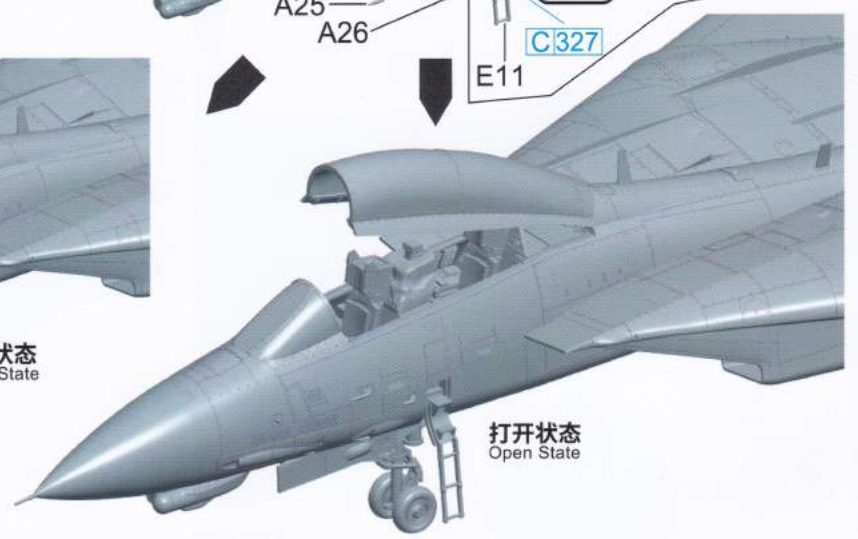
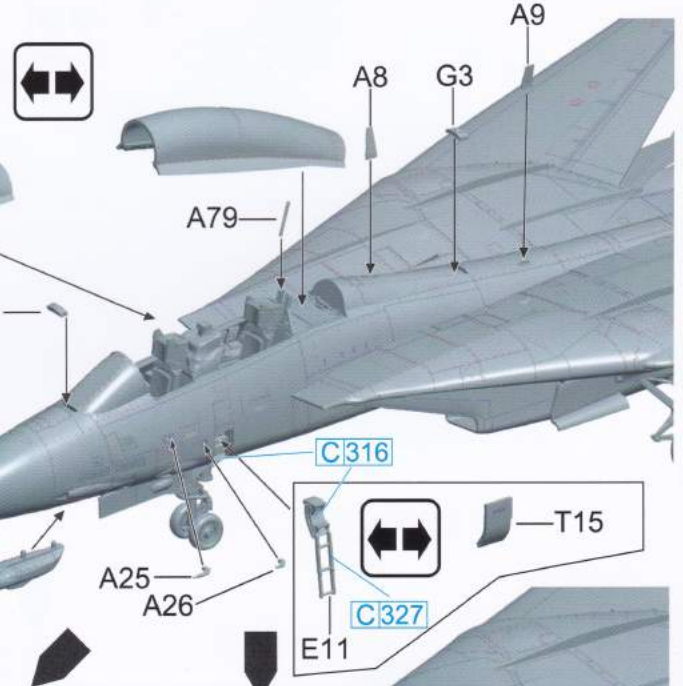
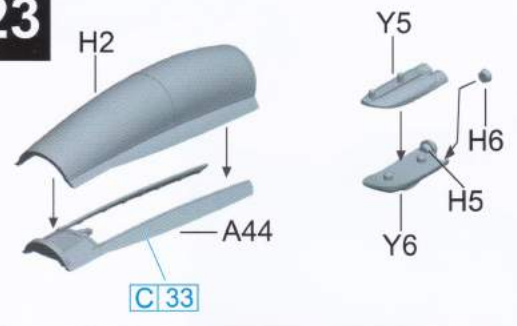

24

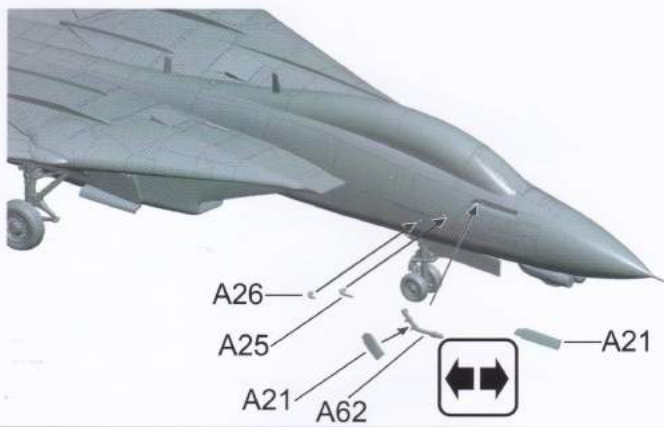

关闭状态
Close State



打开状态
Open State

25

LANTIRN

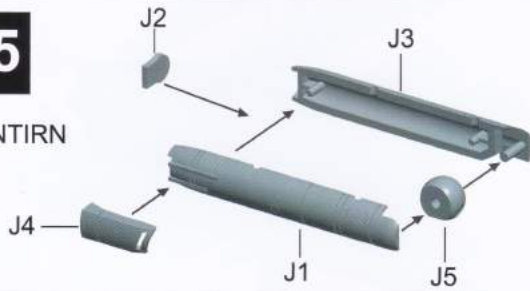

GBU-12

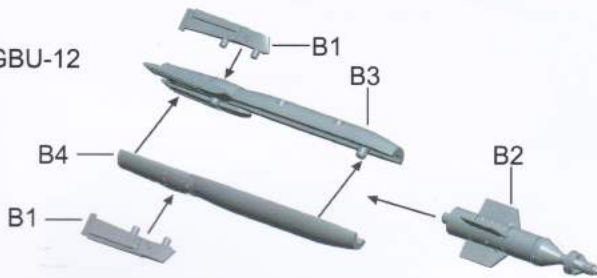

Tank

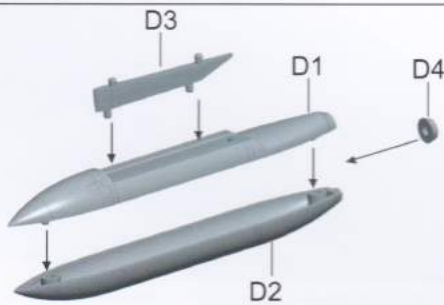

x2

AIM-7

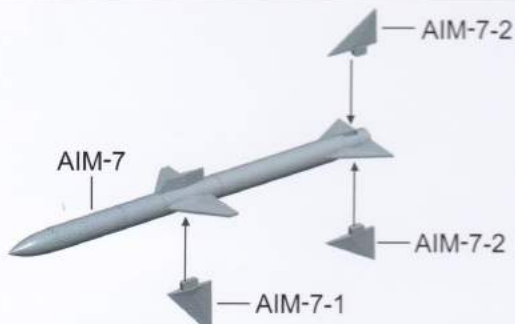

AIM-9

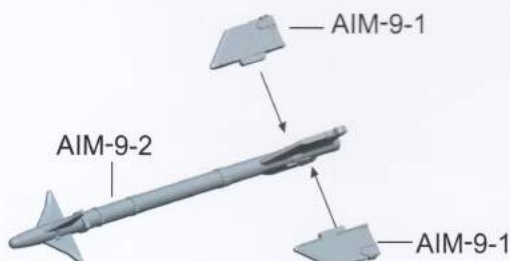

x2

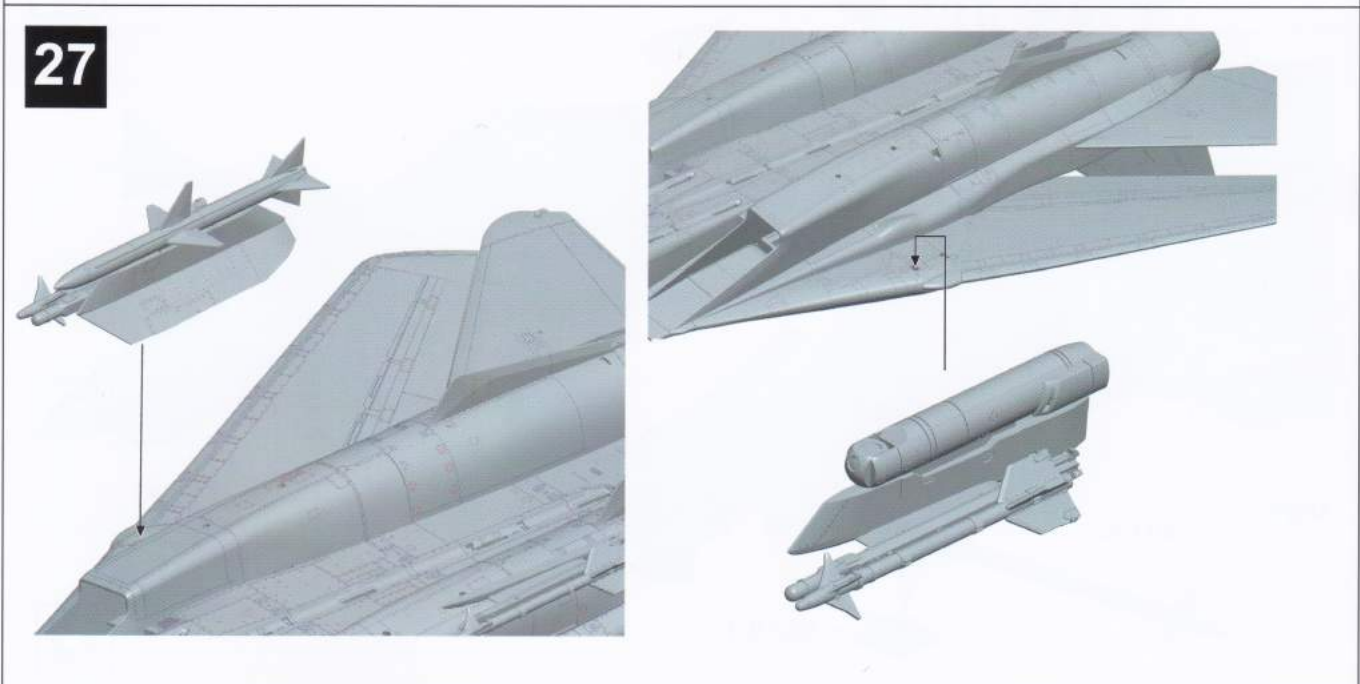
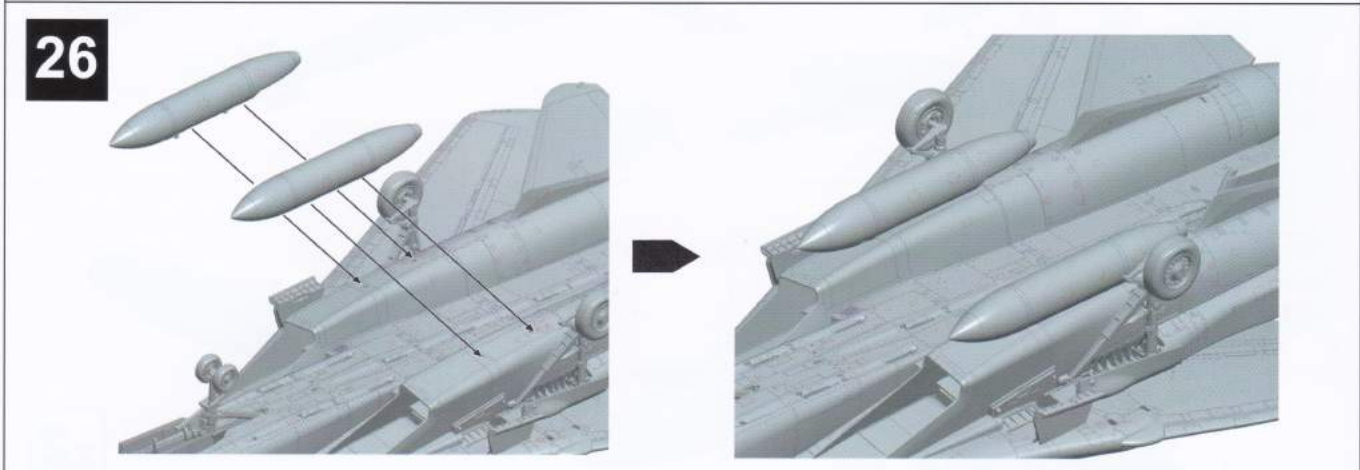
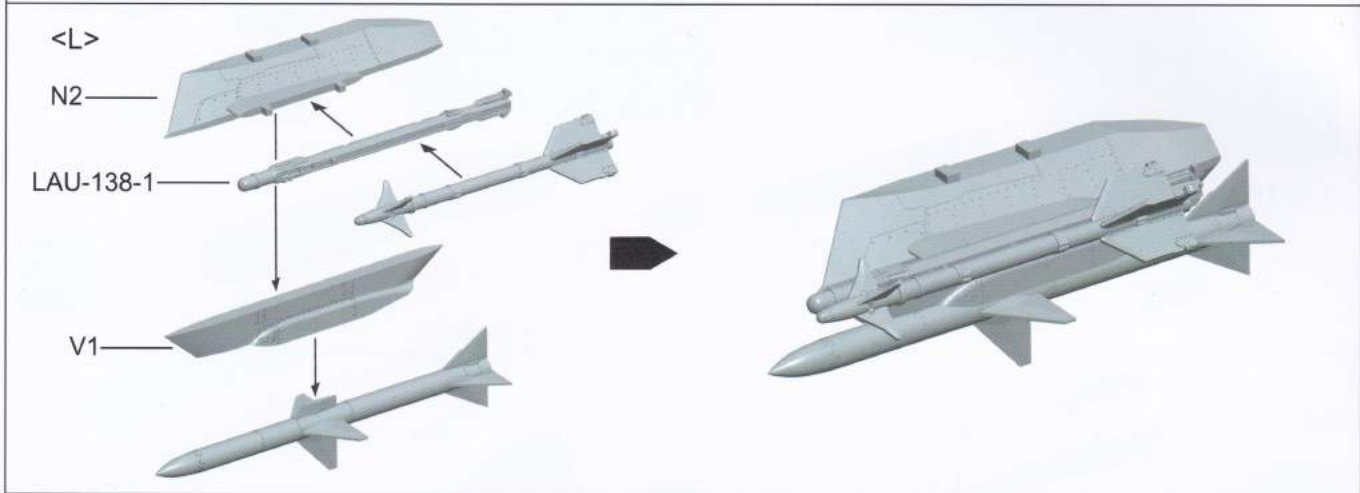
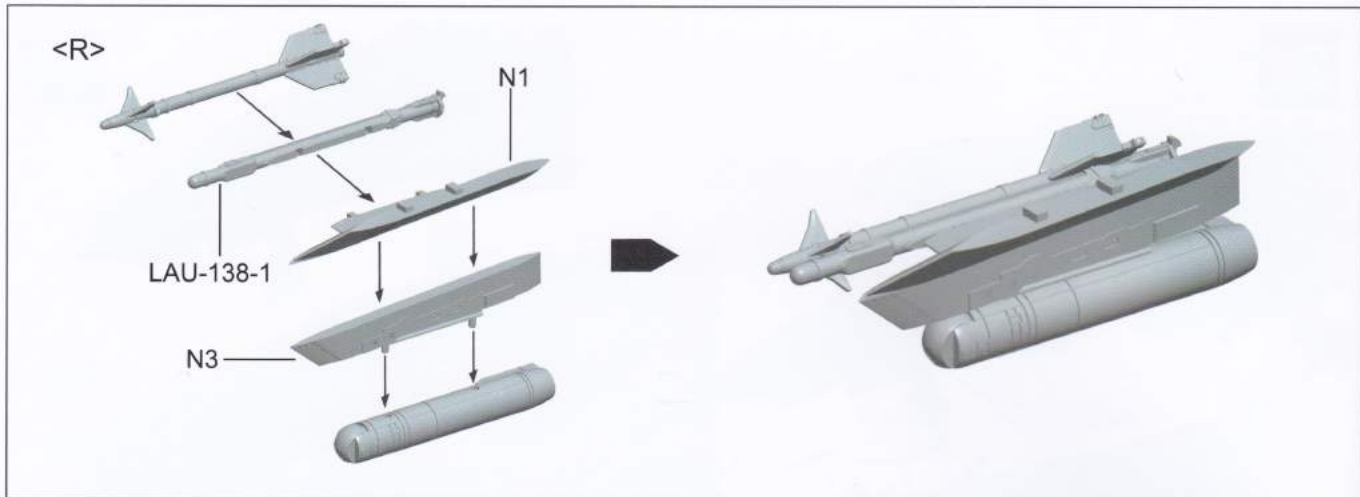

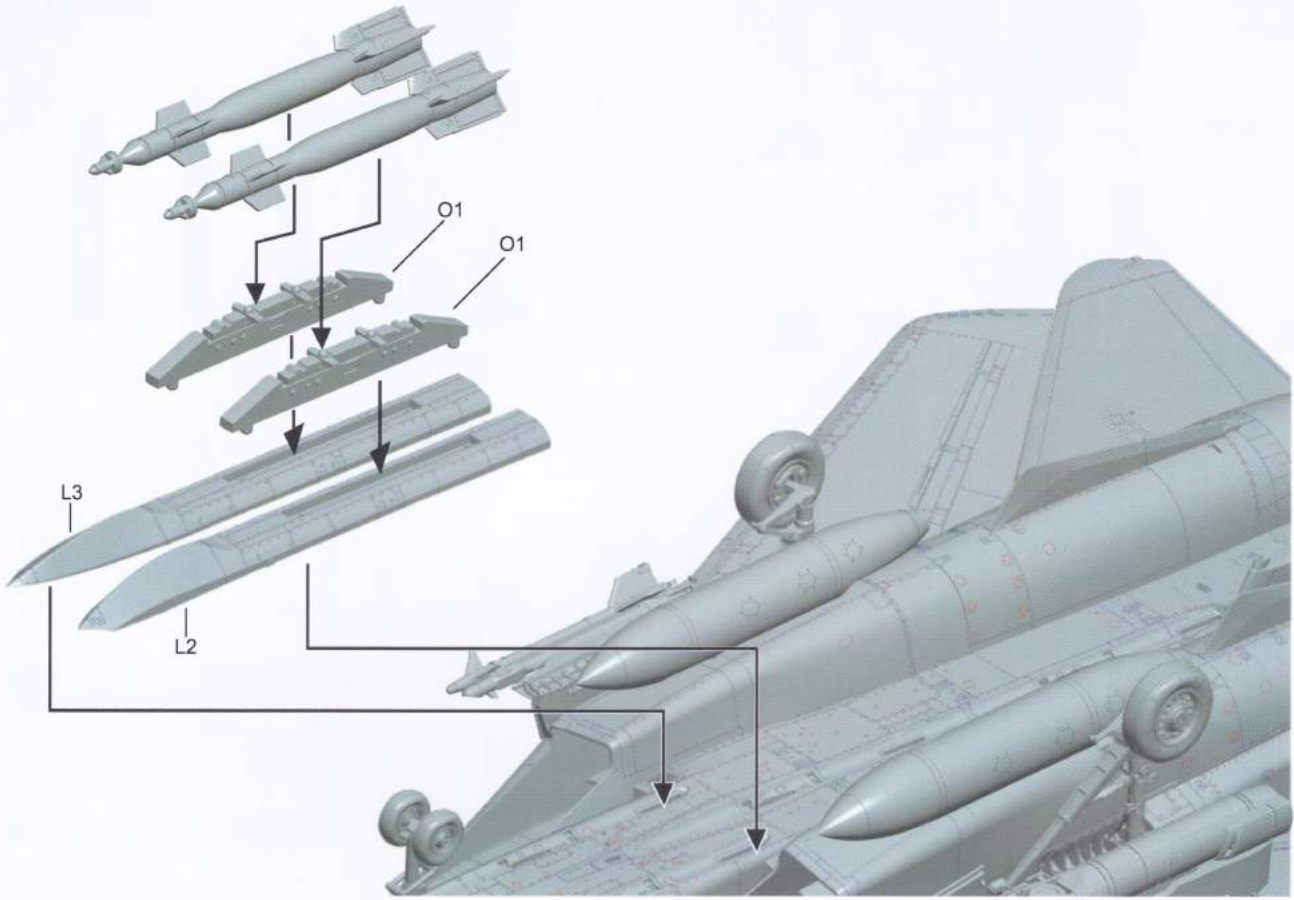

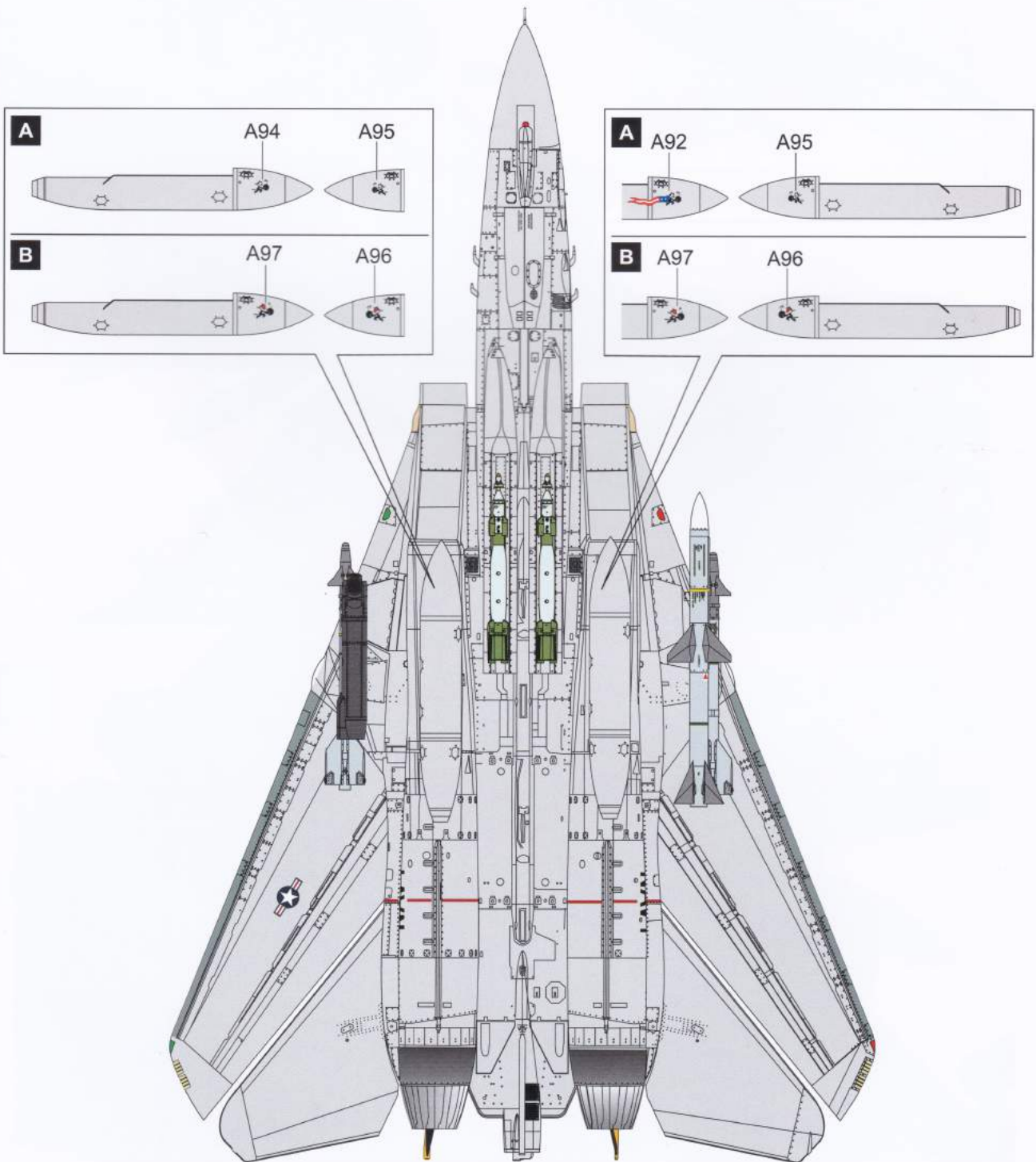
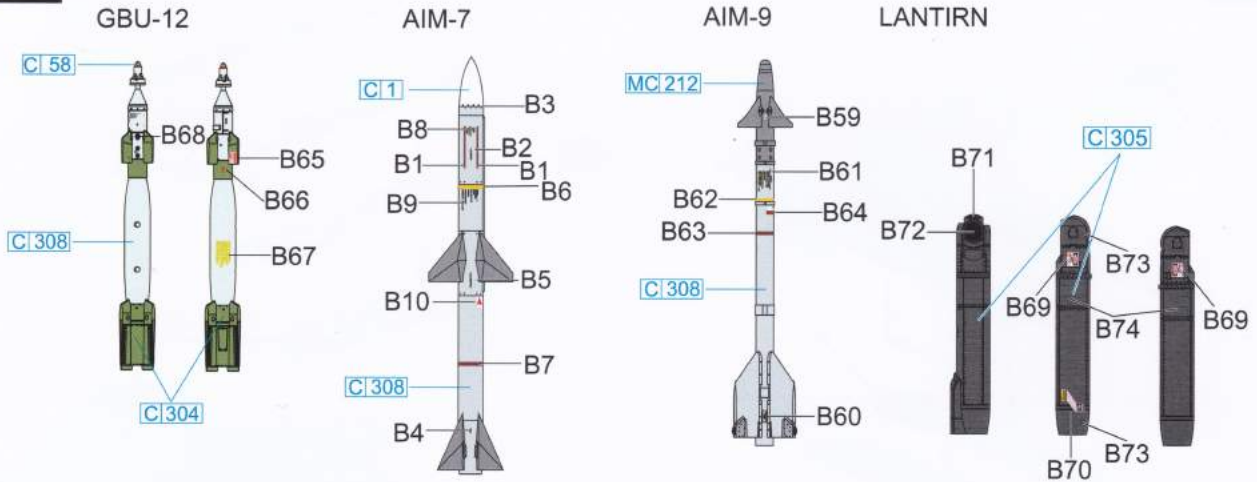

B F-14D BuNo. 164603 Sunset Flight, NAS Oceana, 2006
 F-14D BuNo. 164603 “日落”告别飞行, 奥申纳海军航空站, 2006

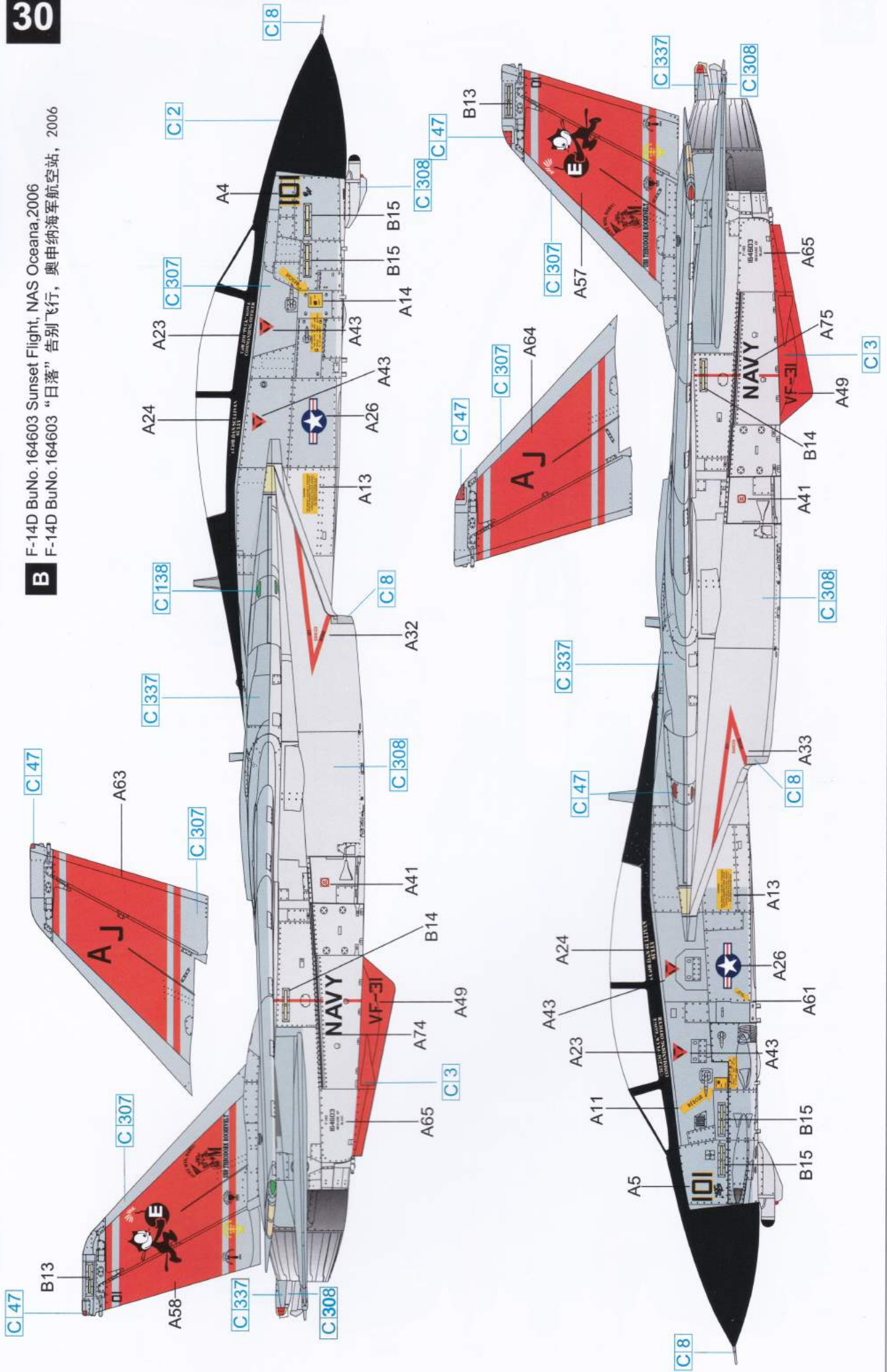

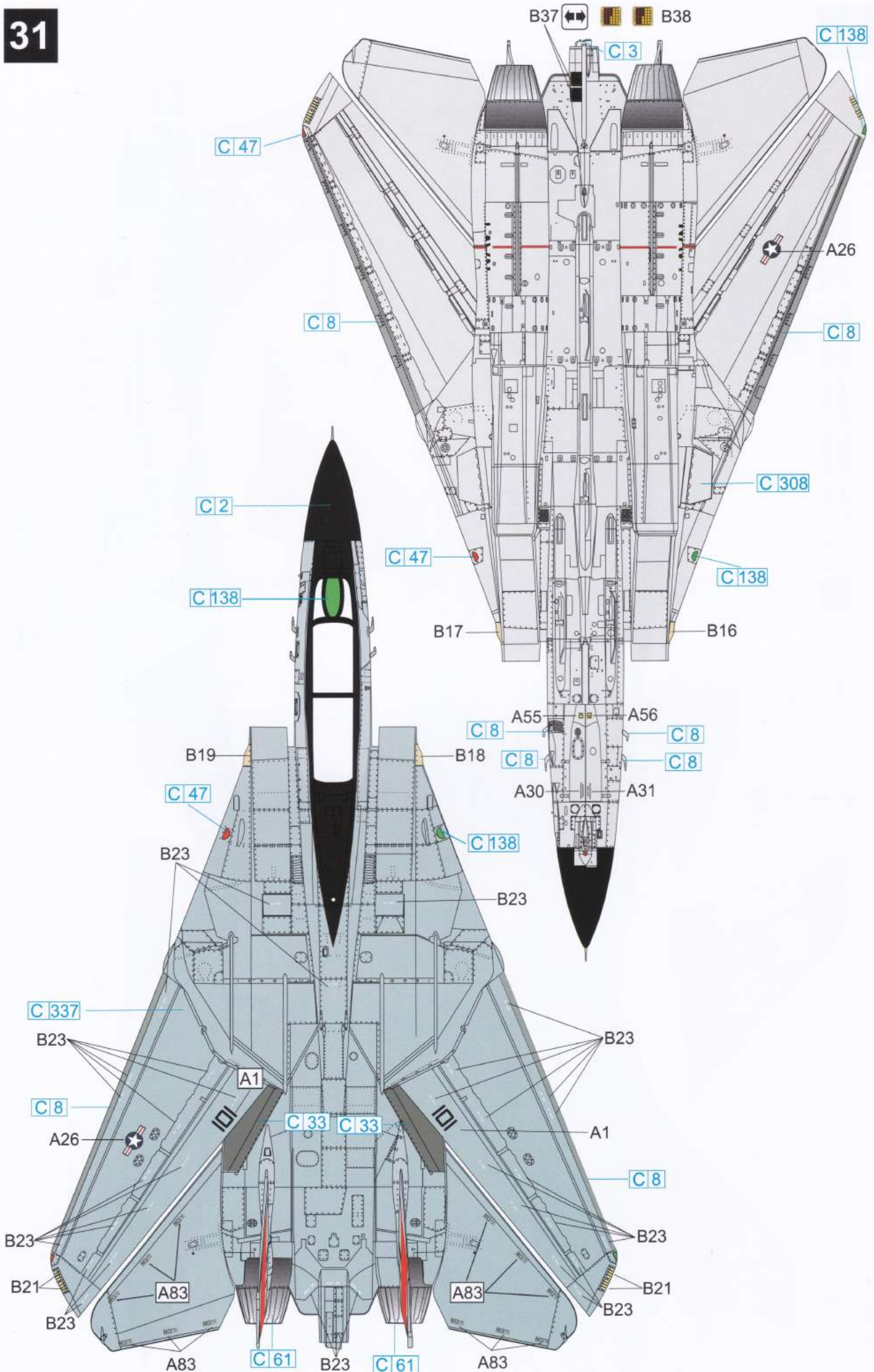

C F-14D BuNo.159609 Sunset Flight, NAS Oceana,2006
F-14D BuNo.159609 “日落” 告别飞行, 奥申纳海军航空站, 2006

