

BOEING 247

BACKGROUND:

The Boeing 247 first flew in February of 1933, during an era of fabric covered biplanes. This monoplane with its clean all-metal construction, retractable landing gear and high cruising speed was as great an improvement in transport design as the jet airliners were during the 1960s.

The 247 entered airline service in March of 1933. In 1934 the "D" type was introduced with several design changes including geared engines, revised cowlings, and an aft-sloping windshield, which replaced the earlier swept-forward type. While many 247s were converted to "D" types, the swept-forward windshield was not always changed.

During 1934, a Boeing 247-D was specially prepared for Colonel Roscoe Turner and Clyde Pangborn, to enter in the MacRobertson London to Melbourne race. Modifications to the aircraft included installation of four 123 gallon and four 90 gallon fuel tanks, larger oil tanks, and revised radio equipment.

Turner placed third, competing against 20 other entries, but might have done better had the race officials permitted a full load of fuel to be carried. As it was, the machine was denied use of one of its tanks.

Turner's aircraft was returned to passenger configuration after the race and served for years as an airliner and executive transport. Later, it was employed by the Department of Commerce, where it was known as "Adaptable Annie". Today, it survives in the Smithsonian Institution.

SPECIFICATIONS:

Wing Span	74 feet	Cruising speed (approx.)	189 M.P.H.
Wing Area	836 square feet	Passenger accomodation	10

ASSEMBLY INSTRUCTIONS:

Before starting, decide whether you want to construct a transport or racing version, as different parts are involved. Although the decals supplied are for United Air Lines NC13347, other versions could be constructed using reference material listed elsewhere on this sheet. Many of the aircraft differed in details, including cockpit upper windows, antenna size and location, exhaust systems and markings.

FUSELAGE: The fuselage door may be installed in either an open or closed position, but is not moveable. If the door is to be mounted in the closed position, it should be carefully fitted into position, trimmed slightly if required and cemented in place. Masking tape strips may be useful to hold door in alignment while the cement dries. **CAUTION:** Avoid allowing liquid cement to creep underneath masking tape, which may damage the surface of the plastic.

Snap each cabin window into place, and secure with a tiny drop of liquid cement applied with a pointed brush. Note: One extra window is provided in case of need.

Select the appropriate windshield style for your model, and carefully remove any flash that may be present. Note that the small triangular areas on the front corners of the swept-forward windshield are not to be removed. Place fuselage halves flat on your working surface, and fit the windshield halves into position. Slight trimming or sanding may be required to obtain proper fitting. The windshield halves should be cemented in place, with the fuselage halves flat on the work

IMPORTANT: READ BEFORE STARTING ASSEMBLY!

This is a complex model, and should be approached with patience and care. Allow plenty of time and check the fit of each part before applying cement. Certain parts may require trimming or filling to achieve the best results. Use a good brand of plastic putty if any filling is required.

GENERAL INFORMATION: Before starting assembly, clean all parts in lukewarm water and liquid detergent, so paint will adhere properly. Use only paints which are recommended for plastic.

For best results when brush painting, use sable hair brushes. Small components may be painted while they are still attached to their plastic "trees". Larger assemblies may be painted after they have been cemented together. When cementing components onto already painted parts, first scrape off the mounting area paint, to permit good adhesion.

Liquid type styrene cement is preferred, and may best be applied with a fine-pointed brush. Avoid using excess cement, which may damage the plastic's surface.

Carefully detach parts from "trees" using a sharp modeling knife. Parts should be detached only as they are needed, to prevent loss. Remove any "flash" which may be present, and using a sanding block, dress all mating surfaces until they match perfectly. A suitable sanding block can be made from a piece of #400 sandpaper, contact-cemented to a scrap of wood.

LANDING GEAR: Paint the interior of wheel and strut wells flat dark grey. Decide whether your model will have the landing gear in ground position, extended flight attitude, or retracted.

Also, choose between faired and unfaired main landing gear struts, if the in-flight extended or ground position is selected. Turner's racer used the unfaired variety.

Choose between the all plastic wheels/tires and the flexible tires. The wheel hub portions should be painted in either case before assembling. Place inboard portions of wheels or wheel hubs onto landing gear axles, and carefully mushroom ends of exles to retain the wheels. This can be done with a tiny soldering iron or a heated metal blade. **CAUTION:** Don't overdo, or wheels will not be free to rotate. Add tires or outer wheel halves, as previously selected. Apply cement sparingly and hold parts in position until they adhere.

For a ground position model, landing gear parts are placed in the wheelwells, alignment checked, and cemented.

If gears are to be in the extended flight position, insert extender pads in between landing gear main struts and inboard angle struts as shown in illustration. When cementing, be certain wheels are correctly aligned as viewed from the bottom of the model.

For a retracted landing gear installation, use the unfaired main struts with the rear portions removed as illustrated. Also insert extender pads as in the extended

Before starting, decide whether you want to construct a transport or racing version, as different parts are involved. Although the decals supplied are for United Air Lines NC13347, other versions could be constructed using reference material listed elsewhere on this sheet. Many of the aircraft differed in details, including cockpit upper windows, antenna size and location, exhaust systems and markings.

FUSELAGE: The fuselage door may be installed in either an open or closed position, but is not moveable. If the door is to be mounted in the closed position, it should be carefully fitted into position, trimmed slightly if required and cemented in place. Masking tape strips may be useful to hold door in alignment while the cement dries. **CAUTION:** Avoid allowing liquid cement to creep underneath masking tape, which may damage the surface of the plastic.

Snap each cabin window into place, and secure with a tiny drop of liquid cement applied with a pointed brush. Note: One extra window is provided in case of need.

Select the appropriate windshield style for your model, and carefully remove any flash that may be present. Note that the small triangular areas on the front corners of the swept-forward windshield are not to be removed. Place fuselage halves flat on your working surface, and fit the windshield halves into position. Slight trimming or sanding may be required to obtain proper fitting. The windshield halves should be cemented in place, with the fuselage halves flat on the work surface to assure a flush fit at the windshield centerline.

Paint the interior, bulkheads, cockpit floor, instrument console and control columns. After the paint on the console has dried, the instrument panel decal may be added. Cement the control columns into the holes in the cockpit floor, and add the console. Paint the pilot seats, and cement onto the front bulkhead, which may then be cemented into one fuselage half. Cement the cockpit floor/console assembly into position against the fuselage wall and front bulkhead.

Paint and assemble the seats, if they are to be used. Round protrusions on the floor tray indicate locations of the chairs. It may be necessary to slightly trim or sand certain chair legs so that they will rest squarely on the floor. The extreme front chairs will have only three legs on the floor, as portions of the floor pan are removed for clearance.

For the racing aircraft, cement tank halves together, clean up joints, and paint. Install tanks into floor pan, noting that the large size fit between the spars, while the narrow ones are located to the front and rear (see photograph).

After the floor tray assembly has been completed, it may be glued into one of the fuselage halves.

Paint and assemble the small navigator's table and radio gear (Turner's racer only), which is cemented into the fuselage half approximately opposite from the door.

Pre-assemble the fuselage halves before gluing. In some cases, a slight amount of trimming of the bulkheads, cockpit floor, or console may be required for a proper fit. Apply cement to the mating edges, and place fuselage halves together. Rubber bands and masking tape will assist holding parts in position while drying.

WINGS: Check fit of top and bottom wing panels, before cementing together. Masking tape may be used to hold the edges together while the cement dries. Carefully remove material from leading edge locations until landing lights and glare shields fit into position. A sharp modeling knife and a small pattern file are useful for this. The backs of the landing lights may be painted silver for improved appearance if desired, before cementing them in position.

Fit and cement the outer wing panels to the wing center section, and allow to dry.

ENGINES: Paint the engines, cowlings, and propellers. Cement engines into cowlings, and insert propeller shafts into engine crankcases. Carefully cement prop

Decide whether your model will have the landing gear in ground position, extended flight attitude, or retracted.

Also, choose between faired and unfaired main landing gear struts, if the in-flight extended or ground position is selected. Turner's racer used the unfaired variety.

Choose between the all plastic wheels/tires and the flexible tires. The wheel hub portions should be painted in either case before assembling. Place inboard portions of wheels or wheel hubs onto landing gear axles, and carefully mushroom ends of exles to retain the wheels. This can be done with a tiny soldering iron or a heated metal blade. **CAUTION:** Don't overdo, or wheels will not be free to rotate. Add tires or outer wheel halves, as previously selected. Apply cement sparingly and hold parts in position until they adhere.

For a ground position model, landing gear parts are placed in the wheelwells, alignment checked, and cemented.

If gears are to be in the extended flight position, insert extender pads in between landing gear main struts and inboard angle struts as shown in illustration. When cementing, be certain wheels are correctly aligned as viewed from the bottom of the model.

For a retracted landing gear installation, use the unfaired main struts with the rear portions removed, as illustrated. Also, insert extender pads, as in the extended position instructions. Apply cement, and position parts in appropriate locations.

STABILIZER: Cement stabilizer top and bottom sections together noting that the top of the stabilizer has a more pronounced curve than the lower portion.

FINAL ASSEMBLY: When the various sub-assemblies are completed, the seams may be smoothed and finished.

The top of the windshield and frames should be painted to match the remainder of the fuselage. Note that some aircraft had windows in the roof, as well as a hatch.

Check for proper fit of fuselage into wing assembly, and when satisfactory, cement in position. Masking tape may be used to secure parts in position while drying if necessary.

Apply cement to lap joints of stabilizers as well as fuselage mating surfaces and install. Check alignment carefully, sighting from front or rear of model.

DECAL INFORMATION:

Decals for both a transport version and Turner's racer are provided. The racer is believed to have carried these markings during its check-out period. Subsequently, other markings were applied, including American flags, "NIP" and "TUCK" engine nicknames, Warner Bros. Comet and Ring-Free motor oil insignia, etc. Dedicated researchers are referred to reference list for additional information.

The transport markings represent the original application. This machine survives today, but has been modified in a number of respects, including markings style as the "CITY OF RENTON".

The furnished Micro Scale decals are extra thin and must be handled carefully for best results. Each decal should be trimmed out separately, and applied as noted on the sheet itself. Caution: Avoid getting decals folded back upon themselves. After decals are thoroughly dry, entire model except for windows, windshield and propellers may be sprayed with clear flat or semi-matt enamel.

DISPLAY STAND: If desired the model may be mounted on a display stand. Enlarge the opening in the circular clear plastic base in order to insert the vertical arm, which may be cemented in place. A 3/32" diameter hole drilled in the bottom of the model near its balance point will adapt the model. This point is approximately in line with the rear wing louvers.

then be cemented into one fuselage half. Cement the cockpit floor/console assembly into position against the fuselage wall and front bulkhead.

Paint and assemble the seats, if they are to be used. Round protrusions on the floor tray indicate locations of the chairs. It may be necessary to slightly trim or sand certain chair legs so that they will rest squarely on the floor. The extreme front chairs will have only three legs on the floor, as portions of the floor pan are removed for clearance.

For the racing aircraft, cement tank halves together, clean up joints, and paint. Install tanks into floor pan, noting that the large size fit between the spars, while the narrow ones are located to the front and rear (see photograph).

After the floor tray assembly has been completed, it may be glued into one of the fuselage halves.

Paint and assemble the small navigator's table and radio gear (Turner's racer only), which is cemented into the fuselage half approximately opposite from the door.

Pre-assemble the fuselage halves before gluing. In some cases, a slight amount of trimming of the bulkheads, cockpit floor, or console may be required for a proper fit. Apply cement to the mating edges, and place fuselage halves together. Rubber bands and masking tape will assist holding parts in position while drying.

WINGS: Check fit of top and bottom wing panels, before cementing together. Masking tape may be used to hold the edges together while the cement dries. Carefully remove material from leading edge locations until landing lights and glare shields fit into position. A sharp modeling knife and a small pattern file are useful for this. The backs of the landing lights may be painted silver for improved appearance if desired, before cementing them in position.

Fit and cement the outer wing panels to the wing center section, and allow to dry.

ENGINES: Paint the engines, cowlings, and propellers. Cement engines into cowlings, and insert propeller shafts into engine crankcases. Carefully cement prop retainers on to rear of prop shafts. **CAUTION:** Do not use excessive amounts of cement, or propellers will not revolve. Tweezers are helpful in positioning propeller retainers. Cement engine assemblies onto nacelles.

EXHAUST SYSTEMS: Turner's racer was equipped with exhaust assemblies which may be identified in the illustrations. The exhaust systems used with the transport version are also furnished. Pipes may be drilled out for greater realism.

The top of the windshield and frames should be painted to match the remainder of the fuselage. Note that some aircraft had windows in the roof, as well as a hatch.

Check for proper fit of fuselage into wing assembly, and when satisfactory, cement in position. Masking tape may be used to secure parts in position while drying if necessary.

Apply cement to lap joints of stabilizers as well as fuselage mating surfaces and install. Check alignment carefully, sighting from front or rear of model.

DECAL INFORMATION:

Decals for both a transport version and Turner's racer are provided. The racer is believed to have carried these markings during its check-out period. Subsequently, other markings were applied, including American flags, "NIP" and "TUCK" engine nicknames, Warner Bros. Comet and Ring-Free motor oil insignia, etc. Dedicated researchers are referred to reference list for additional information.

The transport markings represent the original application. This machine survives today, but has been modified in a number of respects, including markings style as the "CITY OF RENTON".

The furnished Micro Scale decals are extra thin and must be handled carefully for best results. Each decal should be trimmed out separately, and applied as noted on the sheet itself. **Caution:** Avoid getting decals folded back upon themselves. After decals are thoroughly dry, entire model except for windows, windshield and propellers may be sprayed with clear flat or semi-matt enamel.

DISPLAY STAND: If desired the model may be mounted on a display stand. Enlarge the opening in the circular clear plastic base in order to insert the vertical arm, which may be cemented in place. A 3/32" diameter hole drilled in the bottom of the model near its balance point will adapt the model. This point is approximately in line with the rear wing louvers.

DETAILING: If desired, extra detailing may be added, beyond that furnished in the kit. See reference list for additional information. Certain items such as masts, antennas, and exhaust systems varied to suit individual customers, or were modified during the life of the aircraft. Boeing 247s were employed by such diverse countries as Germany, China, Canada, Great Britain, Mexico, Columbia, Nicaragua, Panama, and Brazil. The variety of markings and color schemes used on the machines offers a challenge to avid modelers.

REFERENCES:

1. American Aviation Historical Society Journal Volume 9 Number 4, Winter 1964
2. AIR CLASSICS magazine, August 1968
3. AIR CLASSICS magazine, August 1969

Grateful acknowledgement is extended to the following for assistance and loan of invaluable photographs and drawings: Peter M. Bowers Robert Parks
Victor D. Seely Russ Barrera

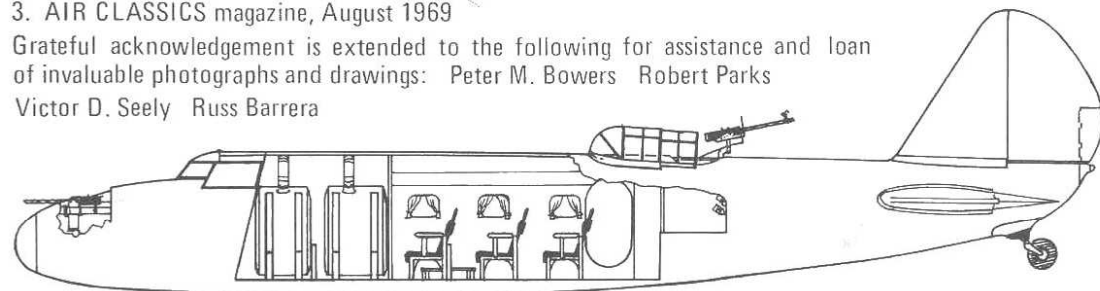

BOEING 247-Y BOMBER VERSION

For those who may care to undertake a conversion, we offer the following information:

Of the several 247s which were sold to foreign countries, perhaps the most interesting was the 247-Y variation which reputedly was purchased for Chiang Kai-Shek. This machine was equipped with two fifty caliber Colt MG-53 machine guns in the nose, and another flexibly mounted in the dorsal position. Four of the fuel tanks from Roscoe Turner's racer were incorporated as well as six passenger seats, which inexplicably were upholstered in polka-dot fabric!

Additional material relating to this aircraft can be found in reference number 1 and reference number 2.

BOEING 247

AFT-SLOPING WINDSHIELD (RACER)

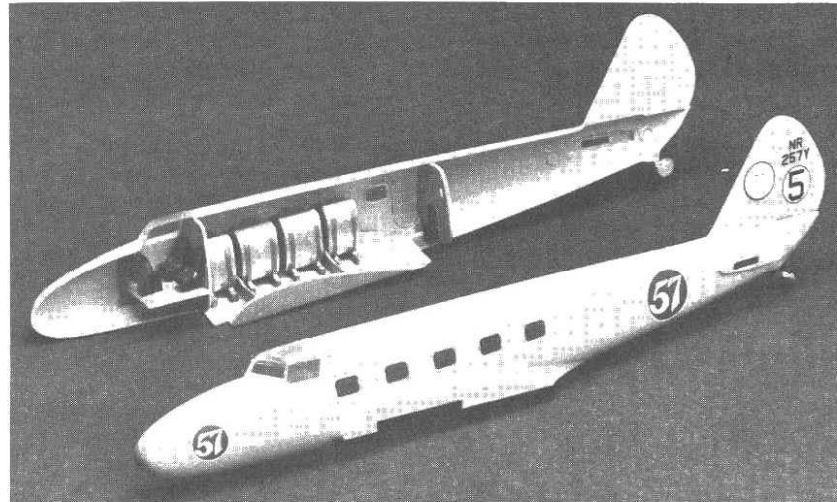
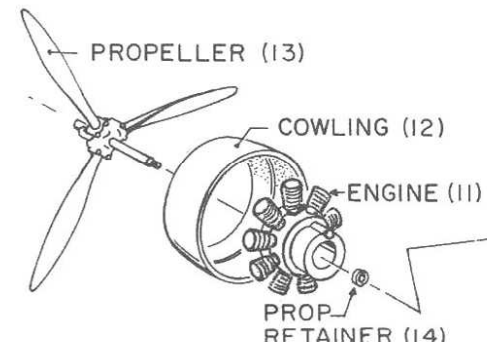
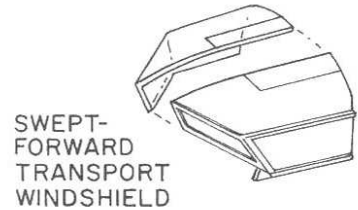
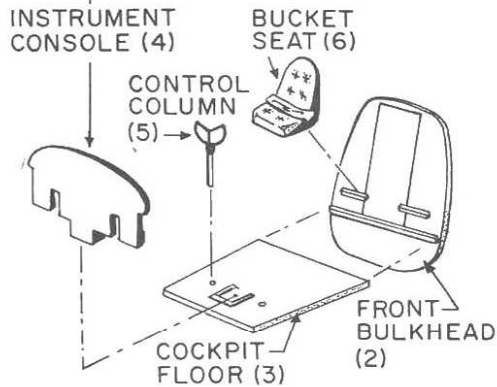
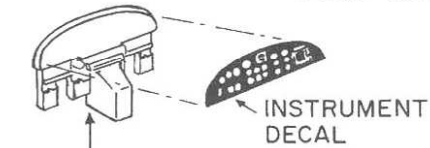

TURNER'S RACER FUSELAGE

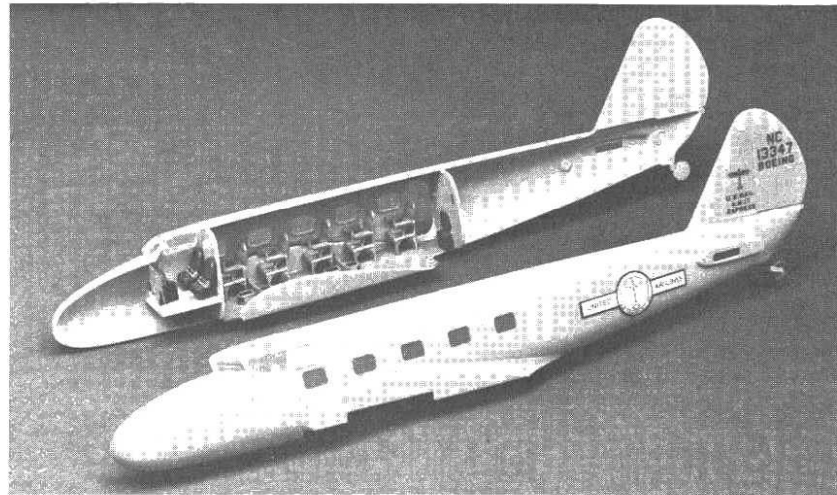

TRANSPORT FUSELAGE

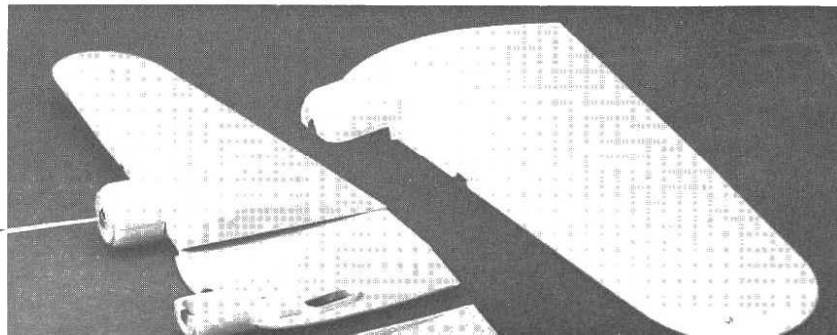

APPLY WHITE DISCS TO FUSELAGE, ALLOW TO DRY, AND APPLY RED "57" DECALS.

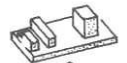
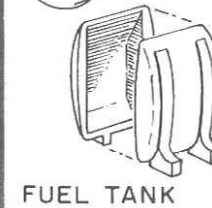

NAVIGATOR'S TABLE (RACER ONLY)
CEMENT TO INSIDE CABIN WALL BENEATH REAR WINDOW.

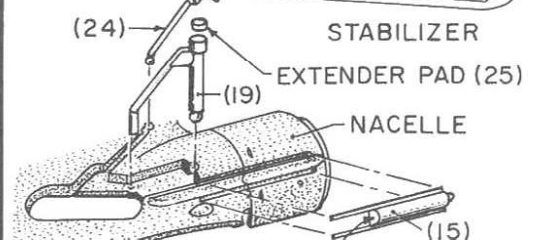
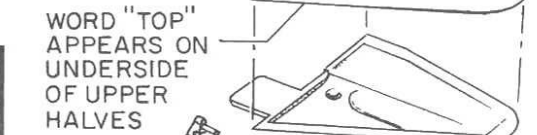
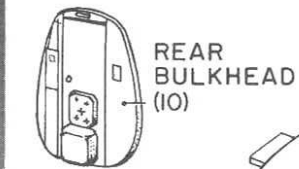
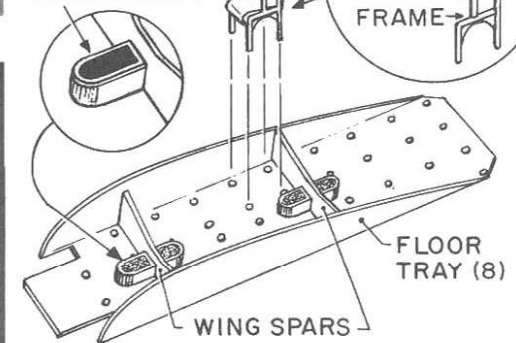

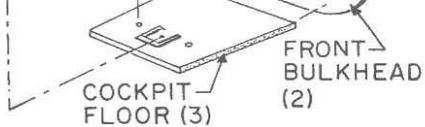

SWEPT-FORWARD TRANSPORT WINDSHIELD

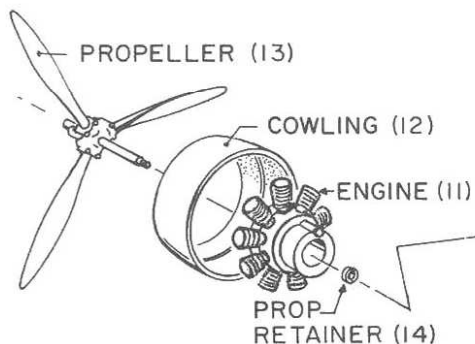
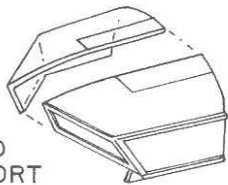

LANDING LIGHT WITH GLARE SHIELD

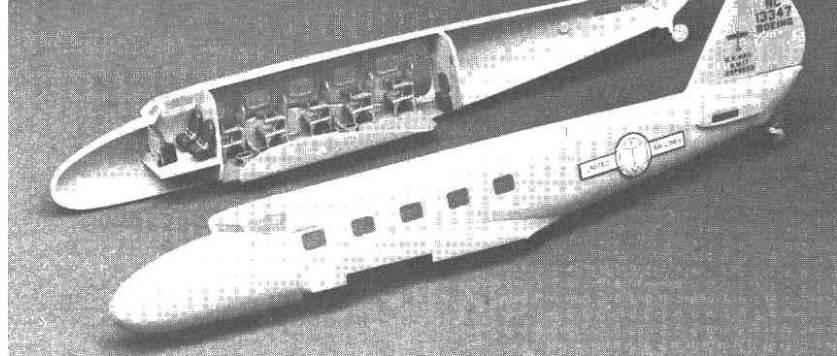

TRANSPORT FUSELAGE

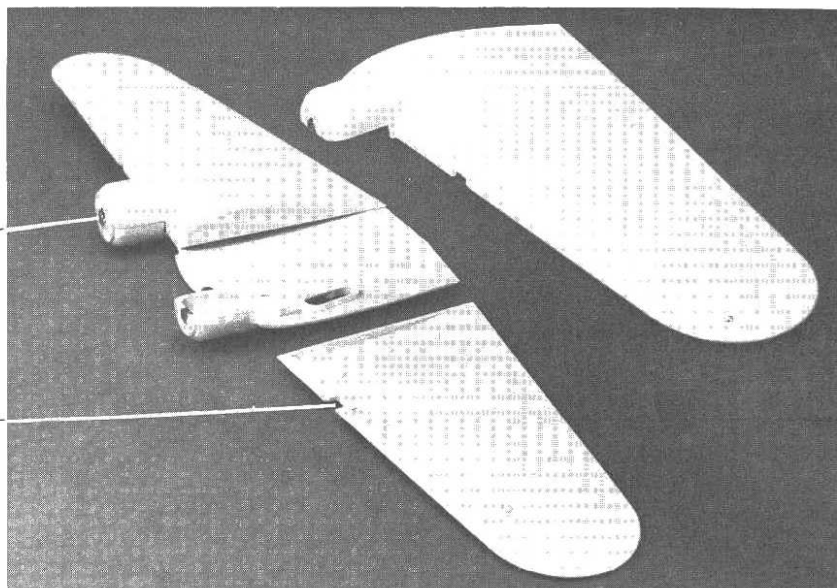

WING ASSEMBLY



WORD "TOP" APPEARS ON UNDERSIDE OF UPPER HALVES

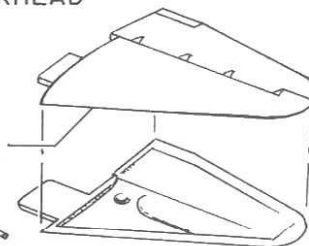

(24) EXTENDER PAD (25)

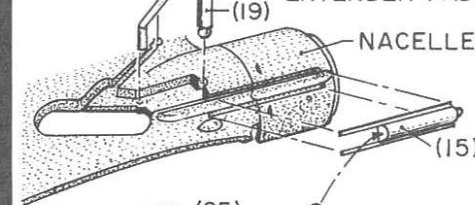

FOR RETRACTED LANDING GEAR, DELETE REAR PORTIONS OF PARTS (19)

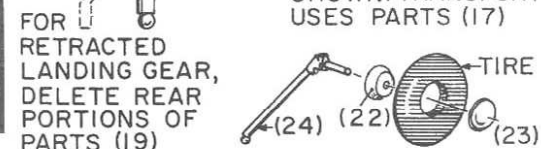

COLOR INFORMATION:

OVERALL COLOR: Grey appearing anodized aluminum with similar color painted fabric surfaces.

INTERIOR: (Turner's racer) Unfinished aluminum.

(Transport) Deep "Gendarme Blue" has been mentioned but doubtless other colors were also employed.

PASSENGER SEATS: Aluminum frames with upholstery and arm rests to match interior color.

PILOT SEATS: Black buckets with leather upholstery. Seat belts were canvas-like, with leather straps and metal buckles.

STEWARDESS FOLDING JUMP SEAT: (in stowed position on rear bulkhead door): Leather or simulated leather.

DOOR HANDLES AND HINGES: Aluminum.

INSTRUMENT CONSOLE: Flat black. Control columns and control wheel spokes: flat black. Control wheels rims brown, representing wood used on originals.

WING LIGHTS: Green starboard; Red port.

TAIL LIGHT: White.

WHEEL HUBS: Steel inner sides; aluminum outer caps.

LANDING GEAR STRUTS: Steel. Extender pads flat black representing rubber boots.

TAIL WHEEL: Aluminum wheel with steel fork.

TIRES: Flat dark grey. NOTE: Flexible tires can be rendered more realistic by sandpapering or steel wooling to remove gloss.

ENGINES: Grey crankcases with black cylinders.

EXHAUST STACKS: Steel or rust.

WHEEL WELLS: Flat dark grey. Openings around exhausts, insides of cowlings, air scoop openings, etc., can be painted flat dark grey for greater realism.

PROPELLERS: Highly polished metal blades; dull metal hub except for polished front extension. Backs of prop blades were generally painted flat black outside cowling area to reduce glare.

Tips of props were often painted with red, white and blue stripes (see illustration).

FUEL TANKS: Polished aluminum, with dull metallic retaining straps.

FLOOR HEATERS (transport version): Rubber step surfaces secured with aluminum frames.

WING SPARS: Simulated leather covered in passenger compartment.



TURNER'S RACER BOTTOM VIEW



TRANSPORT TOP VIEW



OF
ES
K
ID BLUE
TRANSPORT

LANDING LIGHT WITH GLARE SHIELD

RETRACTED LANDING GEAR, DELETE REAR PORTIONS OF PARTS (19)

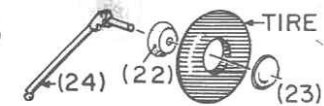

WING ASSEMBLY

COLOR INFORMATION:

OVERALL COLOR: Grey appearing anodized aluminum with similar color painted fabric surfaces.

INTERIOR: (Turner's racer) Unfinished aluminum.

(Transport) Deep "Gendarme Blue" has been mentioned but doubtless other colors were also employed.

PASSENGER SEATS: Aluminum frames with upholstery and arm rests to match interior color.

PILOT SEATS: Black buckets with leather upholstery. Seat belts were canvas-like, with leather straps and metal buckles.

STEWARDESS FOLDING JUMP SEAT: (in stowed position on rear bulkhead door): Leather or simulated leather.

DOOR HANDLES AND HINGES: Aluminum.

INSTRUMENT CONSOLE: Flat black. Control columns and control wheel spokes: flat black. Control wheels rims brown, representing wood used on originals.

WING LIGHTS: Green starboard; Red port.

TAIL LIGHT: White.

WHEEL HUBS: Steel inner sides; aluminum outer caps.

LANDING GEAR STRUTS: Steel. Extender pads flat black representing rubber boots.

TAIL WHEEL: Aluminum wheel with steel fork.

TIRES: Flat dark grey. NOTE: Flexible tires can be rendered more realistic by sandpapering or steel wooling to remove gloss.

ENGINES: Grey crankcases with black cylinders.

EXHAUST STACKS: Steel or rust.

WHEEL WELLS: Flat dark grey. Openings around exhausts, insides of cowlings, air scoop openings, etc., can be painted flat dark grey for greater realism.

PROPELLERS: Highly polished metal blades; dull metal hub except for polished front extension. Backs of prop blades were generally painted flat black outside cowling area to reduce glare.

Tips of props were often painted with red, white and blue stripes (see illustration).

FUEL TANKS: Polished aluminum, with dull metallic retaining straps.

FLOOR HEATERS (transport version): Rubber step surfaces secured with aluminum frames.

WING SPARS: Simulated leather covered in passenger compartment.

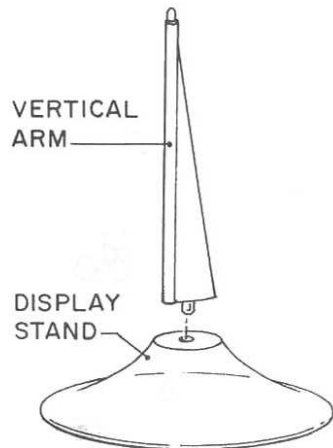

For a more stable base, the clear plastic stand may be cemented to a Williams Brothers "Model-Mount" available at hobby dealers. Extra decals are supplied for use on the base or mount if desired.

TURNER'S RACER BOTTOM VIEW

TRANSPORT TOP VIEW

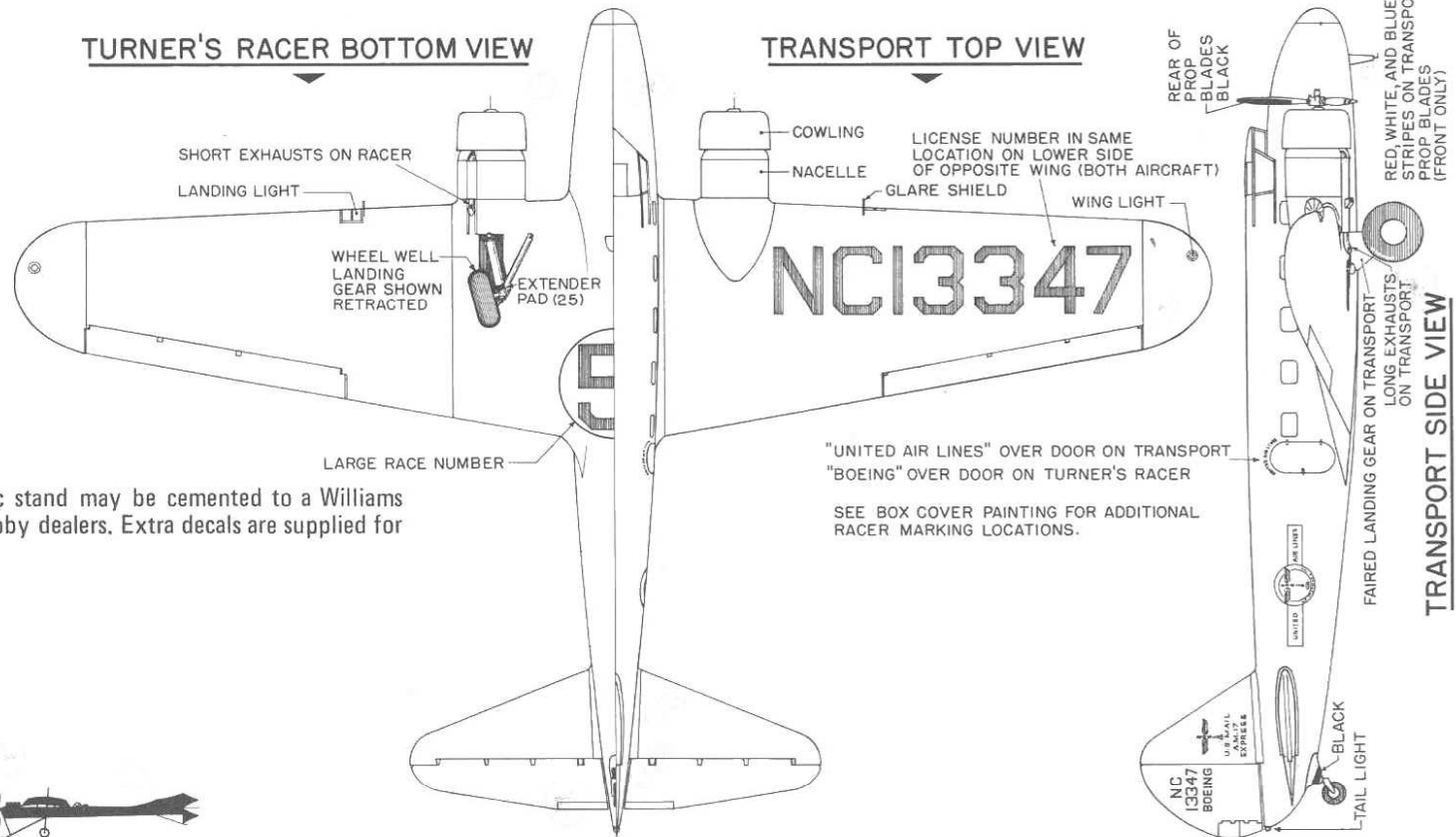

WILLIAMS BROS.
181 B STREET,
SAN MARCOS, CALIFORNIA 92069

HANNAN GRAPHICS

DO YOU WANT TO LEARN MORE ABOUT MODELING?

Write:
IPMS - New Membership
P.O. Box 2555
Long Beach, CA 90801

DO YOU WANT TO FIND OUT THINGS LIKE:

- WHAT HELLCATS AND ZEROS LOOKED LIKE DURING THE BATTLE OF THE MARIANAS "TURKEY SHOOT"?
- HOW TO CONVERT STOCK PLASTIC KITS INTO VARIANTS THAT ARE NOT AVAILABLE AS KITS.
- GERMAN & RUSSIAN ARMOR IN 1943 - 1944.
- THE LATEST CAMOUFLAGE FOR THE F-15 EAGLE.



YES!

IPMS - USA OFFERS YOU...

BACK ISSUES ARE AVAILABLE!

Membership in a non-profit organization founded "BY MODELERS FOR MODELERS".



Membership includes 4 Quarterlies and 6 Updates per membership year. They contain articles on camouflage and marking, super-detailing, model conversions, scratch building, historical information, and much more. For ONLY \$8.50 per Membership Year for Adults (18 and over) \$5.00 per Membership Year for Juniors (Age 17 and under)

Membership in IPMS/USA runs annually from July 1, of the current year through June 30, of the coming year. All those who join for the current year will receive all issues of Volume 12 of the QUARTERLY and UPDATE.

The DOMESTIC MEMBERSHIP RATE for adults, 18 years of age and over, as of July 1, 1976 is still only \$8.50 per year. Multiple year memberships are accepted. DOMESTIC MEMBERSHIP is ONLY AVAILABLE to those RESIDING in the U.S.A., its TERRITORIES & POSSESSIONS. (Including APO & FPO addresses), and CANADA & MEXICO.

A SPECIAL JUNIOR MEMBERSHIP RATE for those 17 years of age and under on July 1, 1976, is available to DOMESTIC MEMBERS ONLY (see above) @ \$5.00 per year. In order to be eligible for the SPECIAL JUNIOR MEMBERSHIP RATE, you MUST INCLUDE YOUR BIRTHDATE, and the NAME OF YOUR PARENT OR GUARDIAN ON THIS FORM.

IPMS-USA MEMBERSHIP FORM 1976-77

(NOTE: It is essential that we be able to read this form, so please print or typewrite legibly!)

NAME (First Name) (Middle Initial) (Last Name) IPMS NUMBER (Renewals Only)

ADDRESS (Please do not abbreviate)

CITY (Please do not abbreviate) STATE ZIP CODE

BIRTHDATE I REQUEST JUNIOR MEMBERSHIP RATE: YES NO
(Must be included if requesting JUNIOR MEMBERSHIP RATE) (You Must Be 17 Years or Under) (Check One)

NAME OF PARENT OR GUARDIAN (Parent or Guardian's Name is ESSENTIAL to insure delivery of JUNIOR MEMBER'S publications)

Make your Check or Money Order payable to IPMS/USA and send to: IPMS/USA, Box 2555, Long Beach, CA, 90801

Typical I.P.M.S. Articles

CURTISS C-46

EMBLEM: Yellow Eagle & Trooper on Blue Field with Yellow Surround. Motto in Blue on Yellow Banner. Words "Troop Carrier Command" circle Emblem in Yellow.



WILLIAMS BROS.

181 PAVNEE STREET • SAN MARCOS, CA. • 92069



C-46 of "Troop Carrier Command". Olive Drab upper surfaces. Neutral Grey under surfaces. All lettering in Yellow. Four bladed propeller.

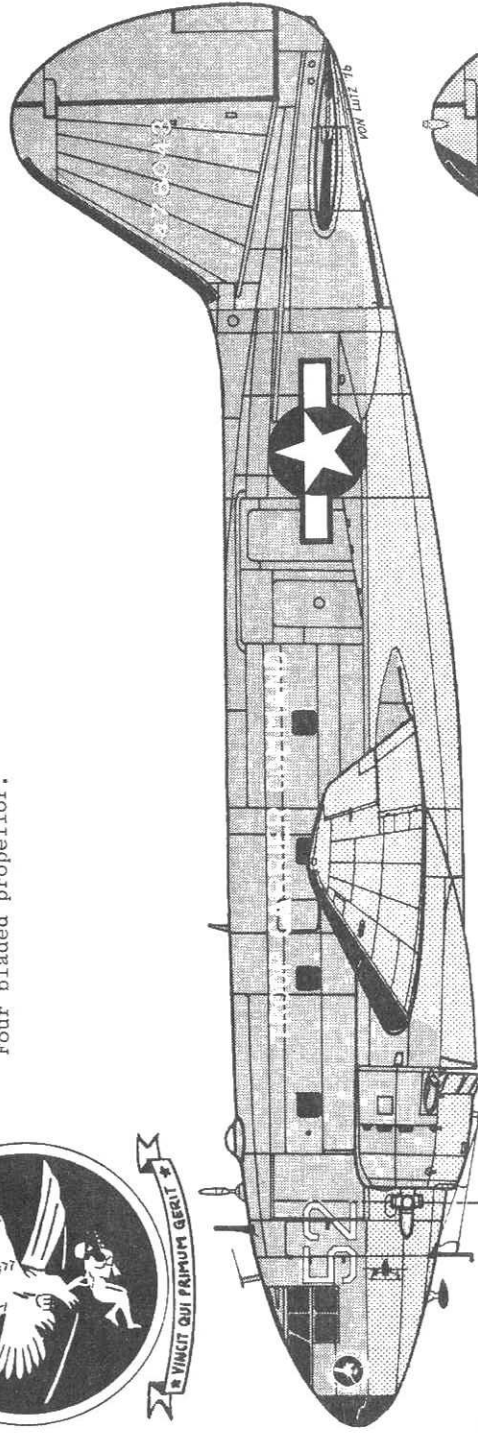

C-46 of "Seaboard World Airlines". White upper fuselage. Black Lettering and Stripes. (SW) on tail in White/Black. Gold Tail. Natural Metal lower fuselage and wings. Three bladed propeller.

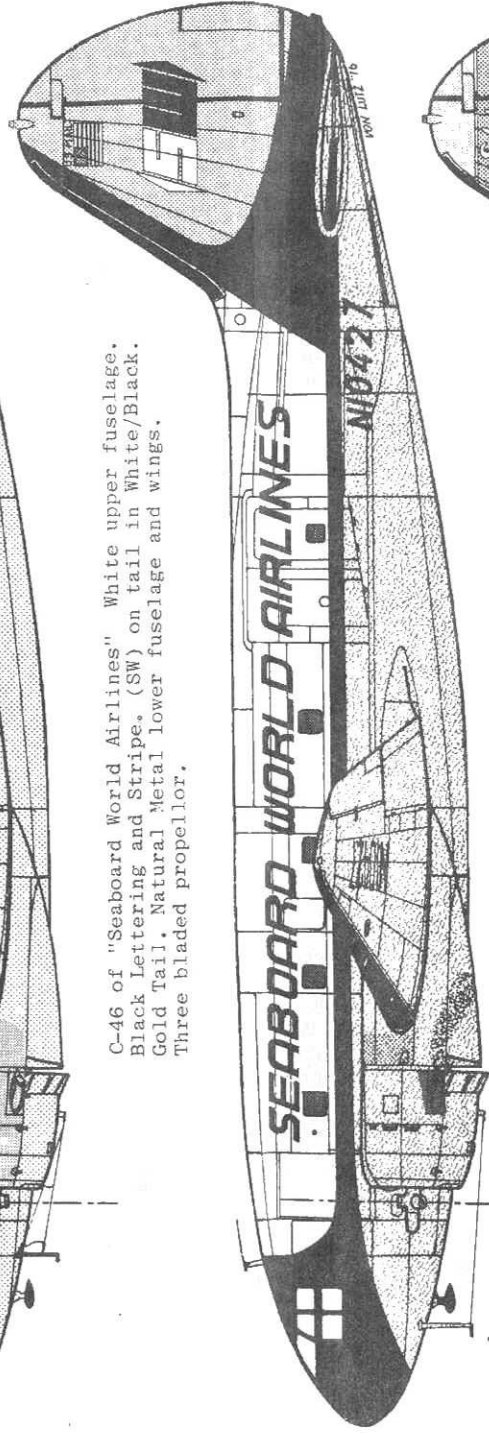

C-46 of "Braniff International Airways". Lower Fuselage and wings are Natural Metal. Red tail with Blue stripes and White lettering. Fuselage lettering "Braniff ... Airways Air Cargo" in Blue with "International" in Red. "Braniff" on nose in White.

