

# A-20B/C HAVOC

Recommended Kit ERTL 1/48th Scale A-20B/C

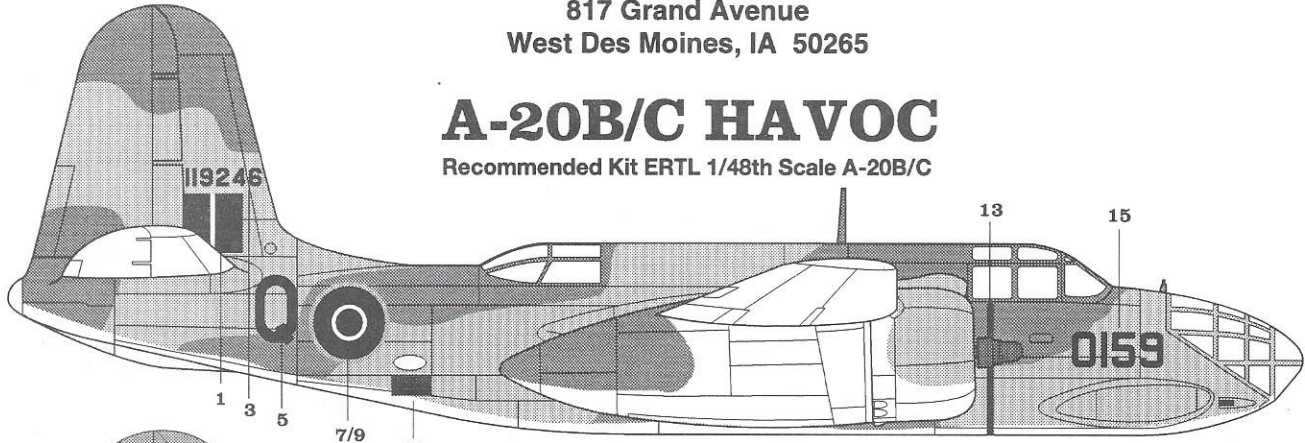

**A** **A-20C Havoc** Serial No. 41-19246, in North Africa sometime in 1942. Flown by Royal Air Force No. 114 Squadron. Finished in Mid Stone, FS 30266 and Field Drab, FS 30118 over Azure Blue, FS 35231. Camouflage scheme for the top and left sides are shown on the reverse side of this sheet.

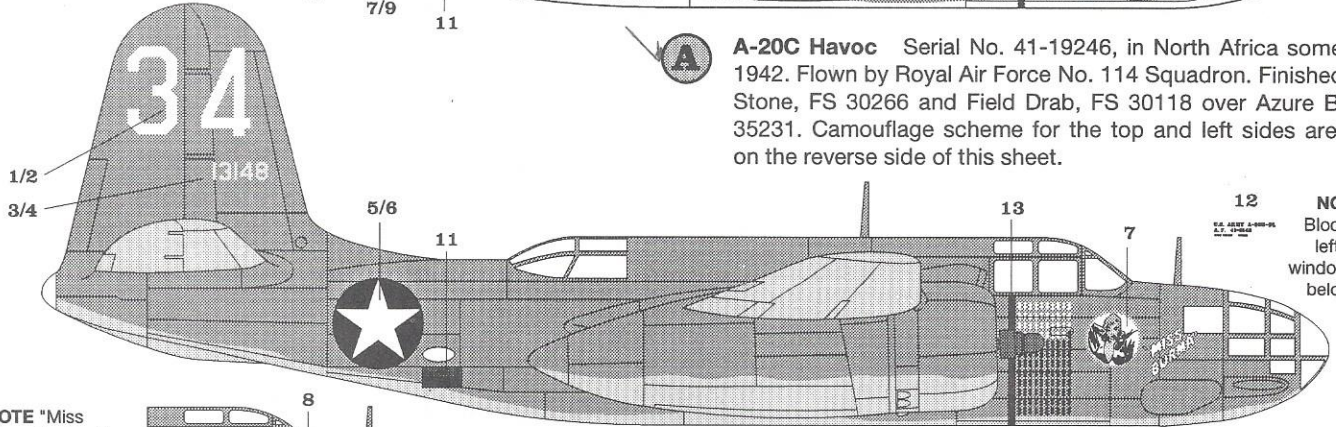

**NOTE** Serial Block fits below left side pilot's window as shown below on "Lady Jean"

**NOTE** "Miss Burma" extends up onto the plexiglass on the nose. This is correct on both versions.

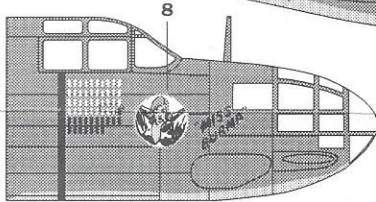

**B** **A-20B HAVOC** Serial No. 41-3178, "from the 47th Bomb Group, 12th Air Force. The markings include an early "Miss Burma" and the veteran "Miss Burma with 120 mission markings. Overall scheme is #41 Olive Drab over #43 Neutral Gray.

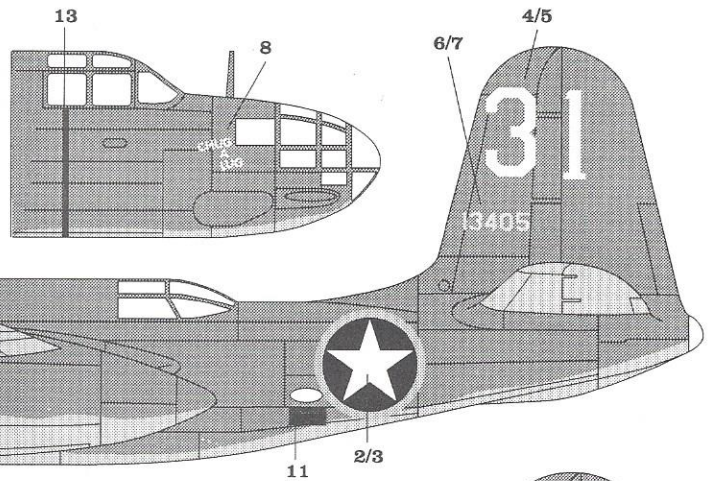

**C** **A-20B HAVOC "Lana"** Serial No. 41-3405 bore the name and portrait of motion picture star Lana Turner on its nose. was flown in North Africa and Italy. The nose has been freshly painted forward of the prop warning stripe only on the left side of the aircraft. The right side of the aircraft carried the name "Chug-a-Lug". Overall scheme is #41 Olive Drab over #43 Neutral Gray.

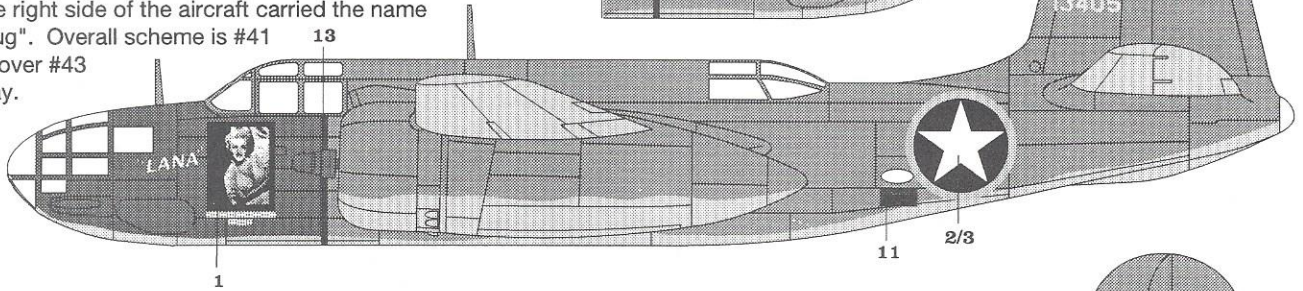

**D** **A-20B HAVOC "Lady Jean"** Serial No. 413171, from the 47th Bomb Group, 12th Air Force at Youks Les Baines, Algeria, in December, 1942. Overall scheme is #41 Olive Drab over #43 Neutral Gray.

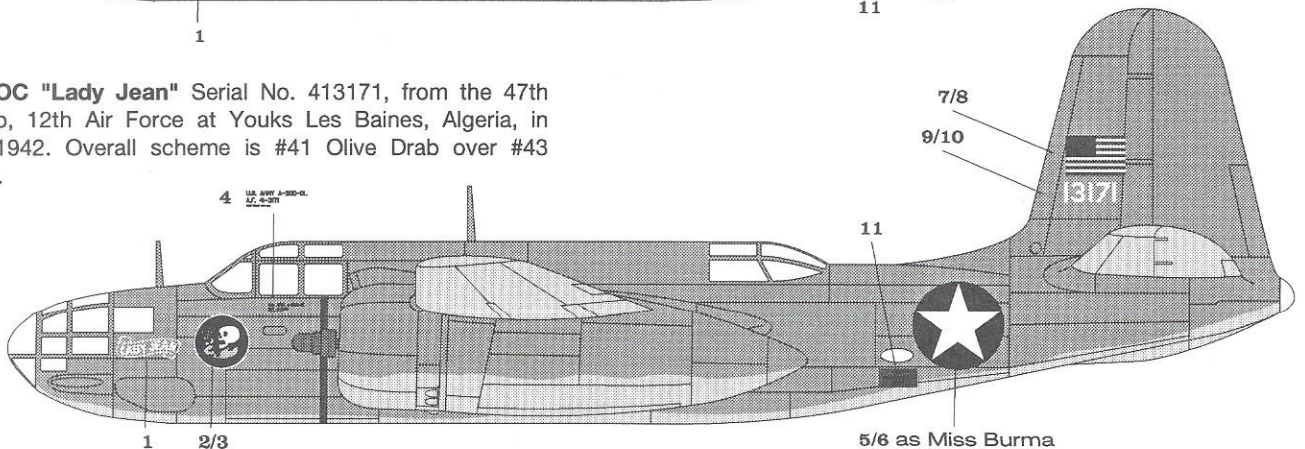



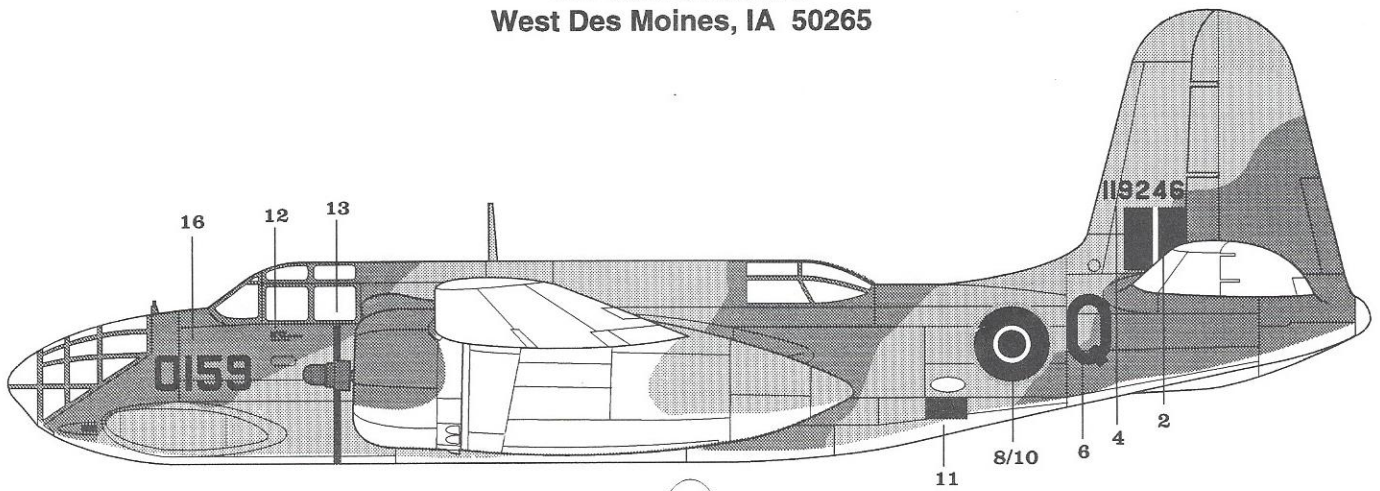

Artwork by **Raven™**  
SCALE REPRODUCTIONS

**A** **A-20C Havoc** Serial No. 41-19246.. Finished in Mid Stone, FS 30266 and Field Drab, FS 30118 over Azure Blue, FS 35231.

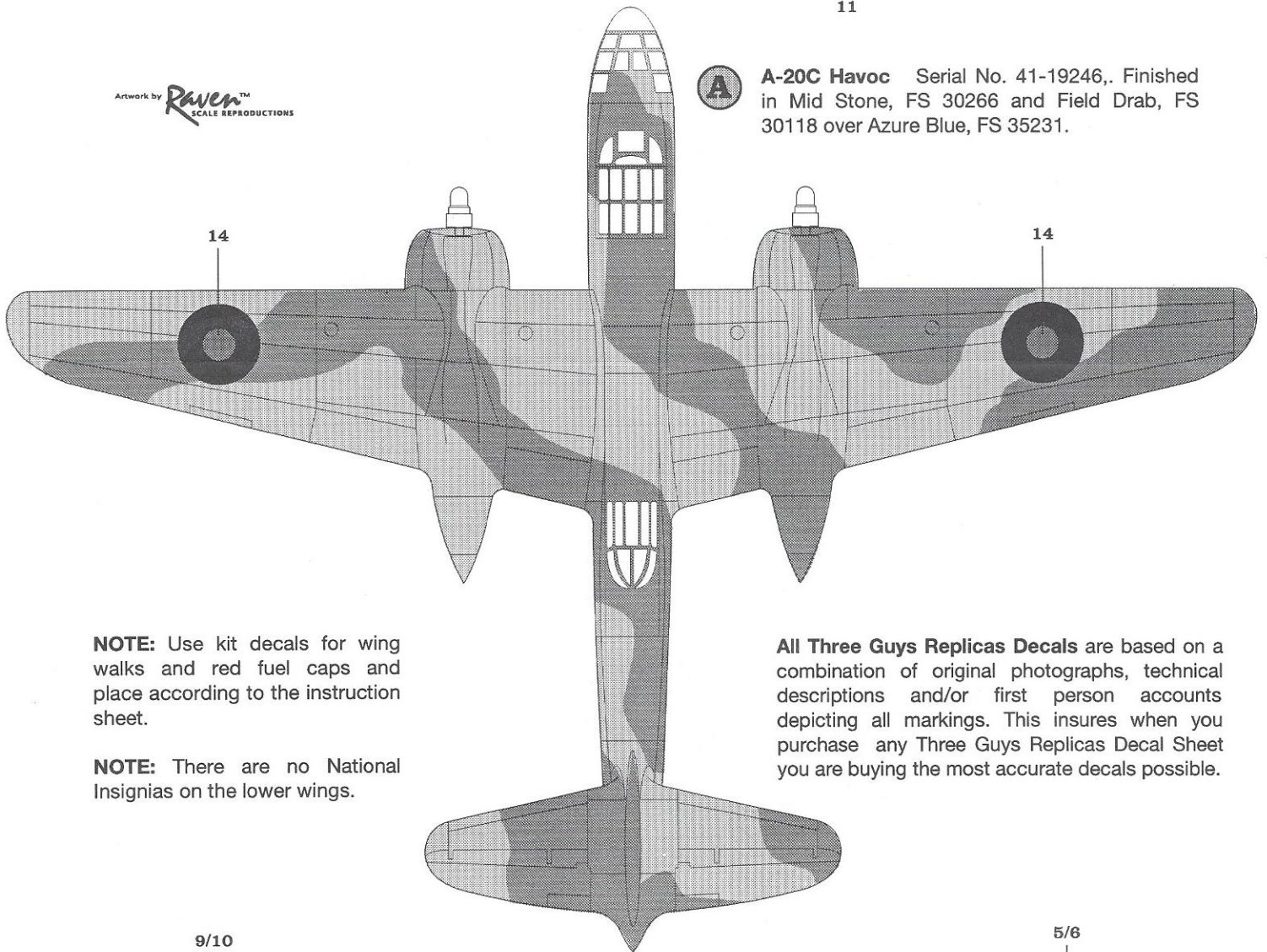

**NOTE:** Use kit decals for wing walks and red fuel caps and place according to the instruction sheet.

**NOTE:** There are no National Insignias on the lower wings.

**All Three Guys Replicas Decals** are based on a combination of original photographs, technical descriptions and/or first person accounts depicting all markings. This insures when you purchase any Three Guys Replicas Decal Sheet you are buying the most accurate decals possible.

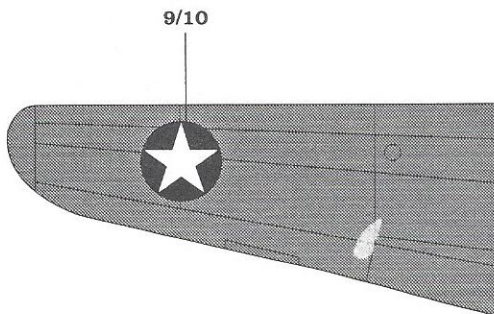

**D**

**A-20B HAVOC "Lady Jean"**  
Serial No. 413171, from the 47th Bomb Group, U.S. markings and American Flag appear on both upper and lower main wings.

