



Schwerer kleiner Pzkwfwg.



Booth2019

Vor dem Zusammenbau lesen!

DW35019

Attention · 取り扱い上のご注意 · 注意事項

1. Please read this manual through carefully before assembling and keep it for future reference.
2. WARNING: Kit contains small and sharp parts. Children under 14 years old should be supervised to ensure that they do not play with any parts.
3. WARNING: Keep plastic bags away from babies and small children to avoid the danger of suffocation.
4. Be sure to ventilate the work area and keep away from fire or flammable gas when using cement or paint.
5. It is highly recommended to do pre-assembling or dry-fitting before gluing. Test to ensure that the pieces will fit together properly or neatly.
6. Beware of personal injury that may be caused by sharp tools (such as Design Knife) & ensure that fingers are free from the path of the blade.

1. 組み立てを始める前に、この取扱説明書をよく読んで理解してから正しく使用してください。また必要ときに、参照できるように大切に保管してください。
2. 警告: 組み立て部品には鋭利な物、小さい部品がございます。14歳未満のお子様には与えないで下さい。ケガ防止を妨ぐため幼児の手の届かないところに保管し、十分ご注意ください。
3. 警告: 窒息の危険がございますので、パーツの入っていたビニール袋を幼児がかぶらないようご注意ください。開封後はすぐに捨ててください。
4. 接着剤やラッカー塗料エナメル塗料等をご使用の際は、必ず換気をし、火の気に十分ご注意ください。
5. 接着剤で貼り付ける前にまず仮組みをして、部品に間違いがないか、向きは合っているかを確認してください。
6. 制作時にはカッターナイフ等、鋭利な工具でケガをしないよう十分注意し、刃の進む先に手を置かないでください。

1. 請在組裝之前仔細閱讀本手冊，掌握組裝流程與要點，並妥善保管本手冊以供日後參考。
2. 警告: 套件包含細小與銳利部件，應照看好14歲以下幼童，確保他們不會玩耍任何部件，也不可將部件含在口中或者吞食。
3. 警告: 不要讓嬰兒或幼童接觸包裝盒內的塑膠袋，防止他們將塑膠袋套在自己的頭部而發生窒息的危險。
4. 在使用膠水黏接模型或者進行噴油作業時，應遠離火源或者易燃氣體，並使工作區域保持通風。
5. 在使用膠水黏合之前應先進行假組，檢查部件之間的配位是否正確或者合適。如有配位不適的情形發生，則可做修正工作。
6. 在製作時應小心勿被鋒利的工具（例如筆刀）刺傷，在切割部件時要確保手指避開刀鋒的運動方向。

Assembly Guide Icons · 組み立て指示記号について · 組裝指示符號

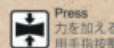
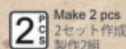
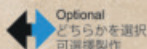
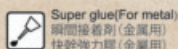
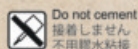
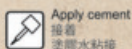

It depends on what type of glue being used. 2-3 mins for super glue to dry & 10-20 mins for Poly cement. Hair dryer is useful for quick hardening. 完全に乾くまでの時間は接着剤の種類によります。瞬間接着剤なら約2~3分、プラモデル用接着剤なら約10~20分です。ドライヤーを使えば乾きも早くなります。幹固の時間取決於膠水類型。強力膠或快幹膠需要2-3分鐘，塑膠模型膠水需要10-20分鐘，可使用電吹風加速幹固。

1

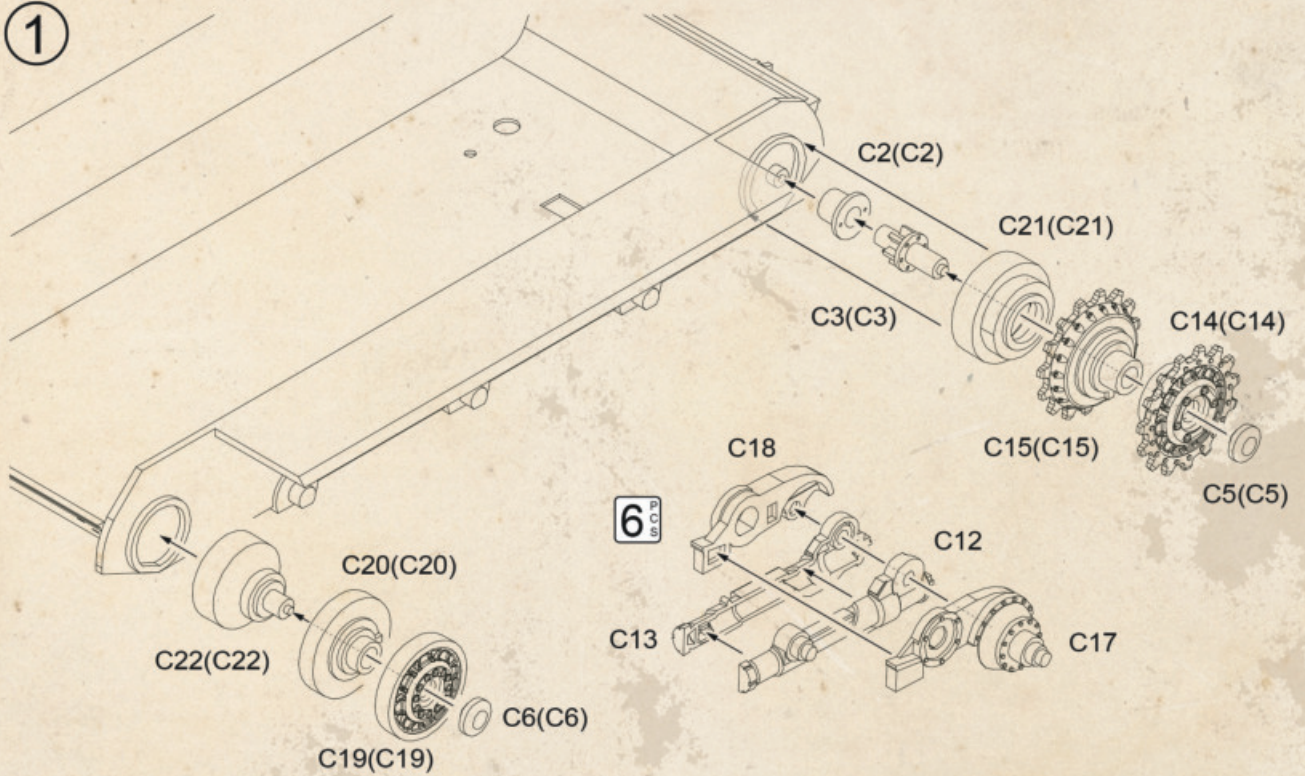

2

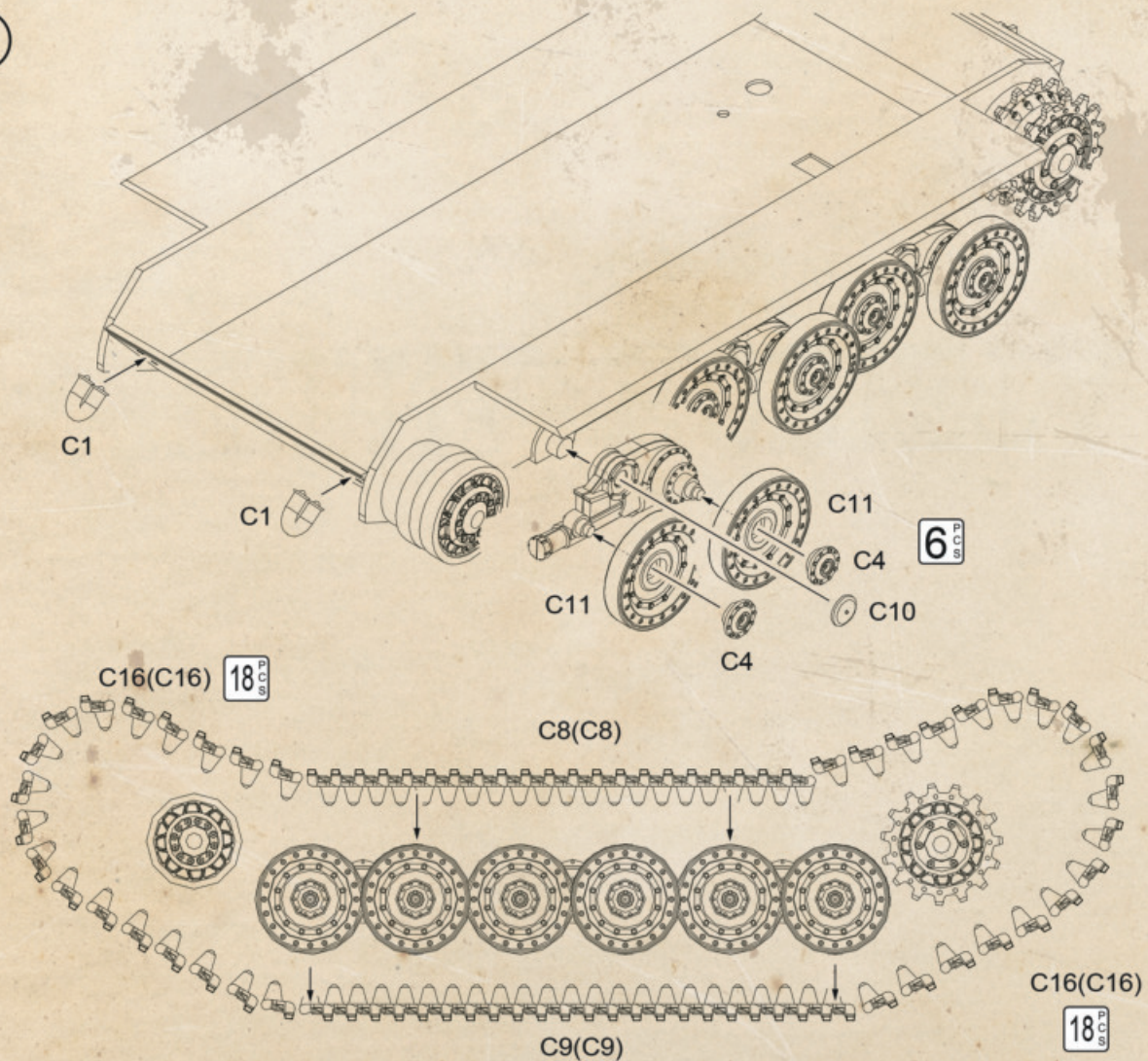

3

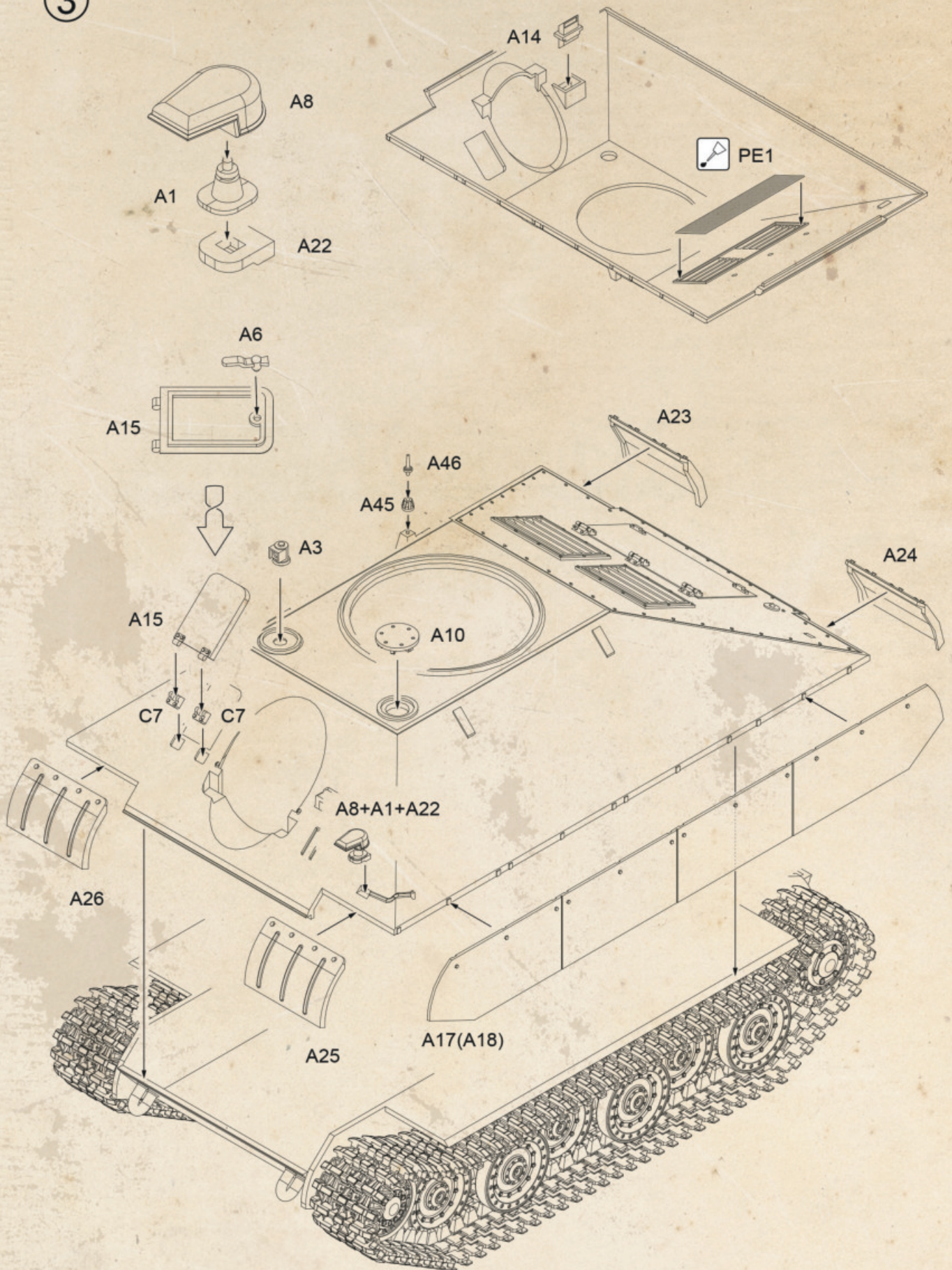

4

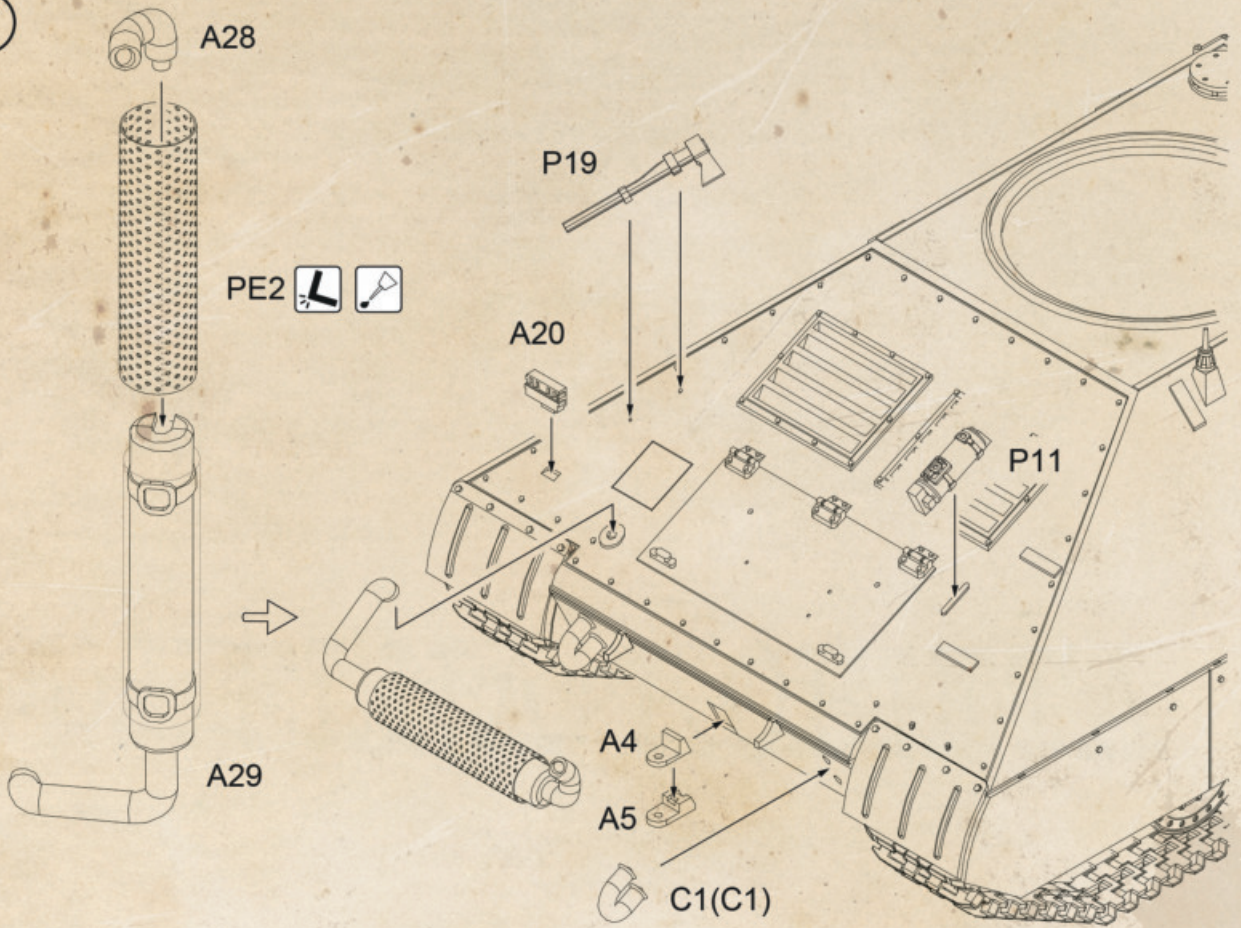

5

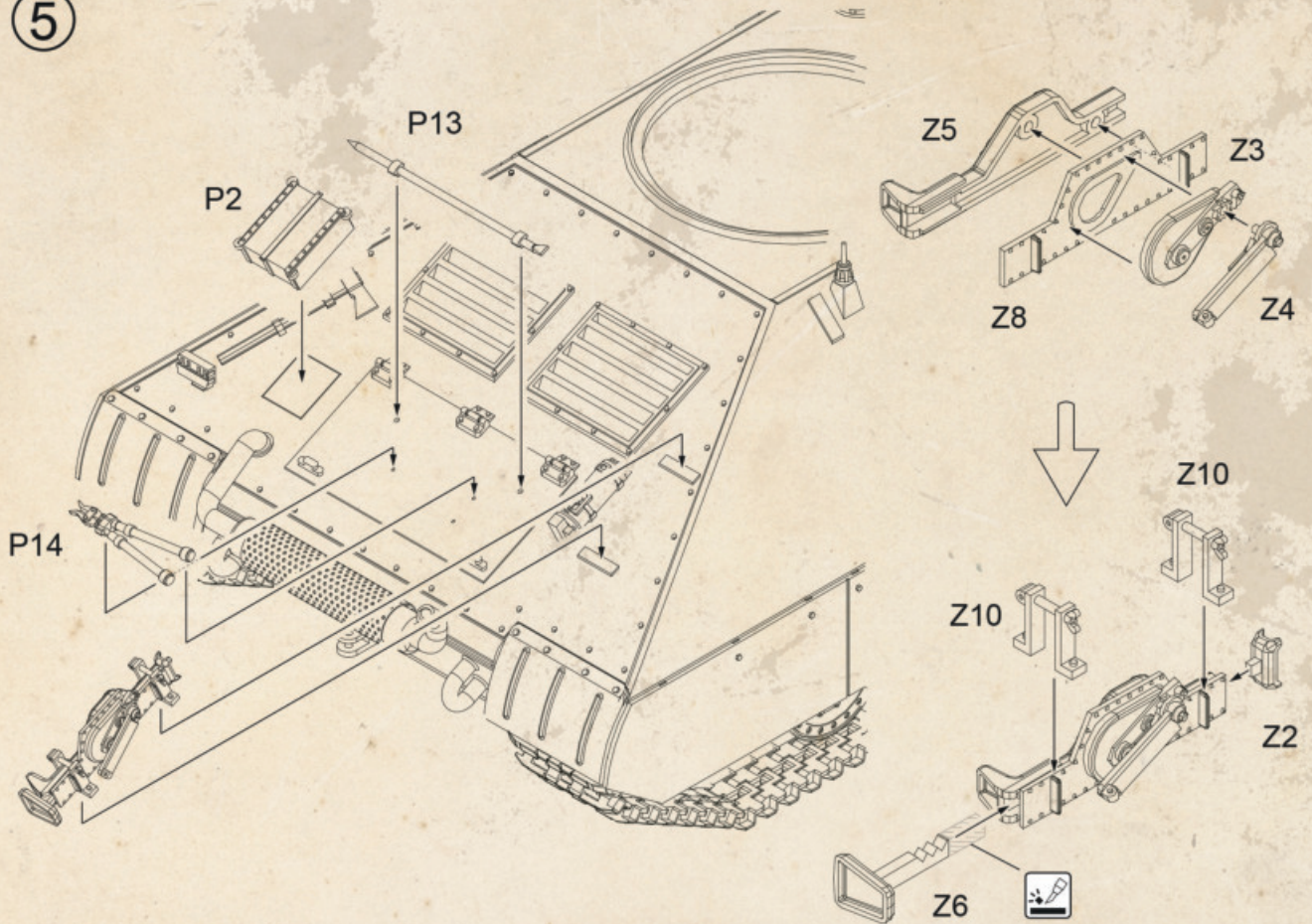

6

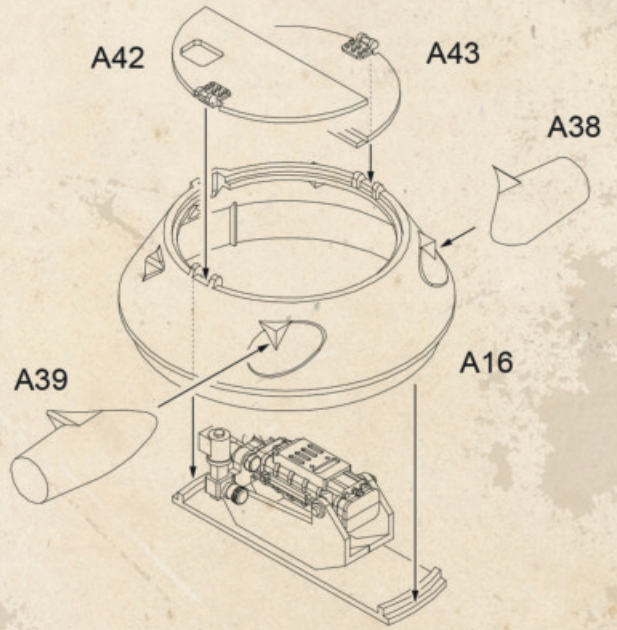
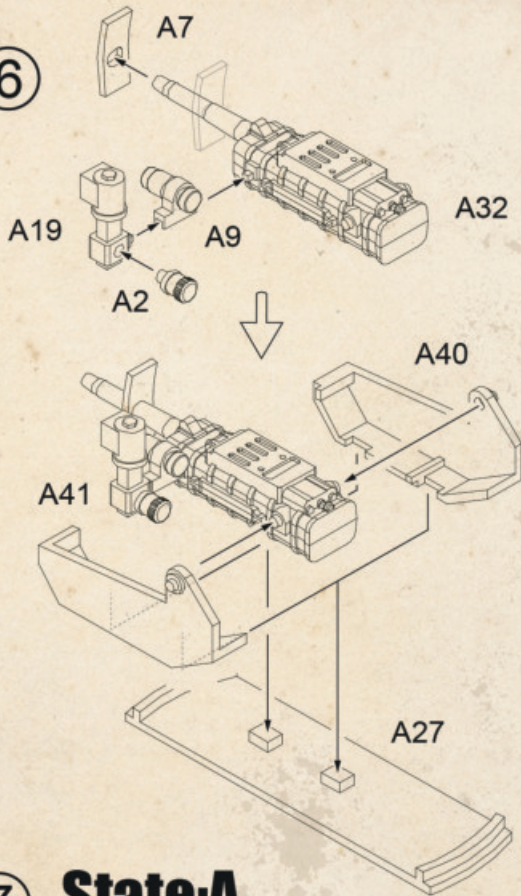

7



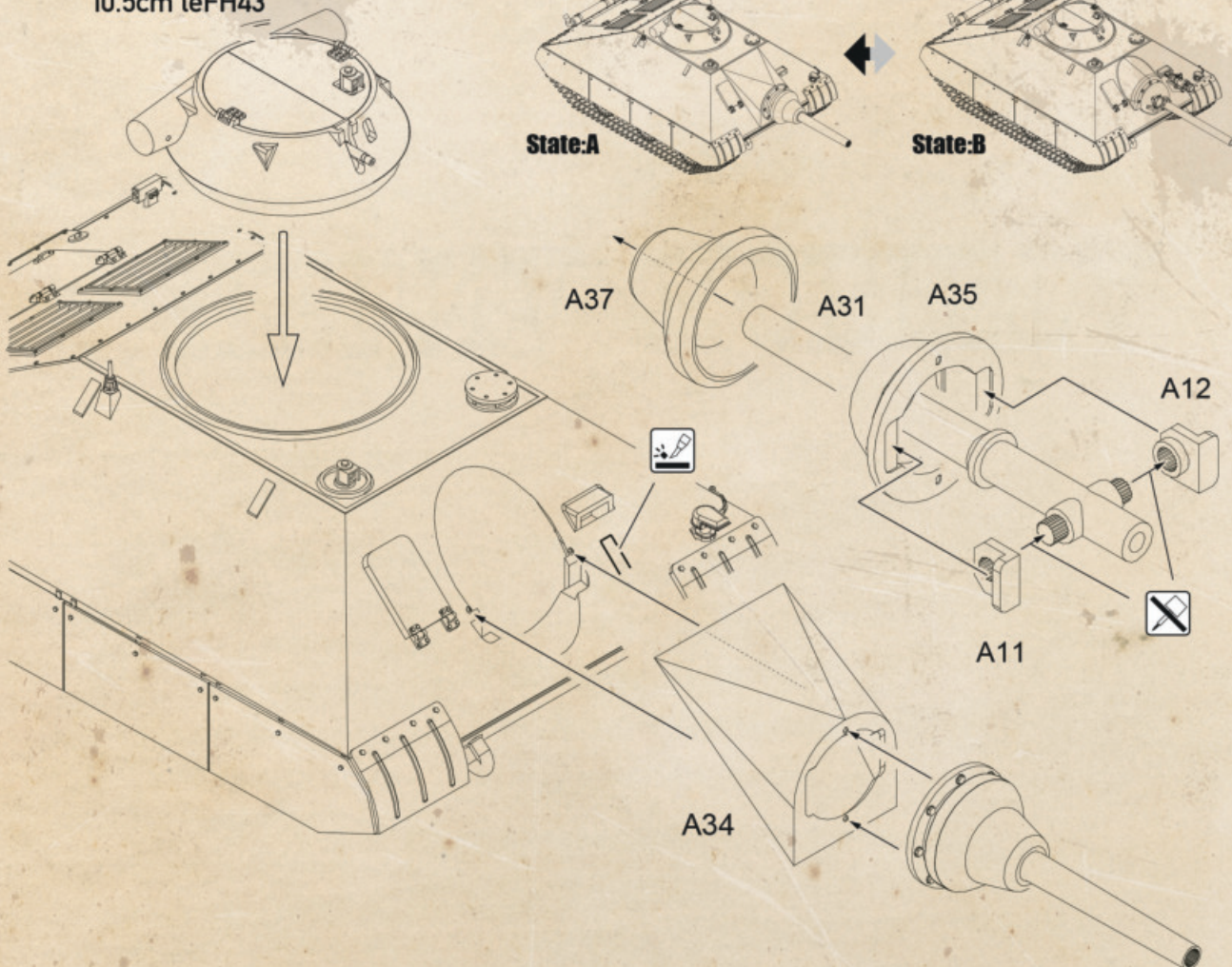
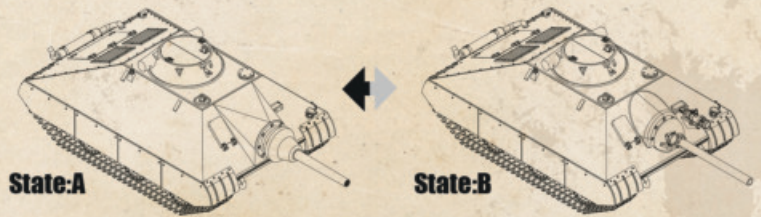

State:A
10.5cm leFH43

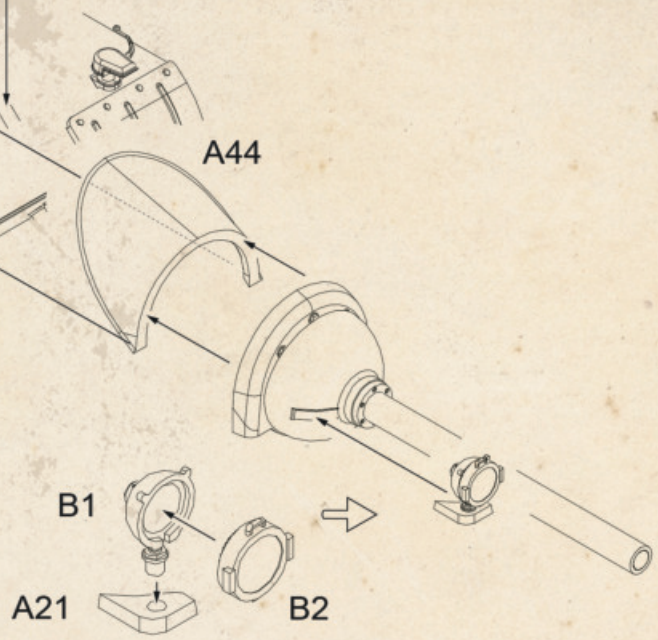
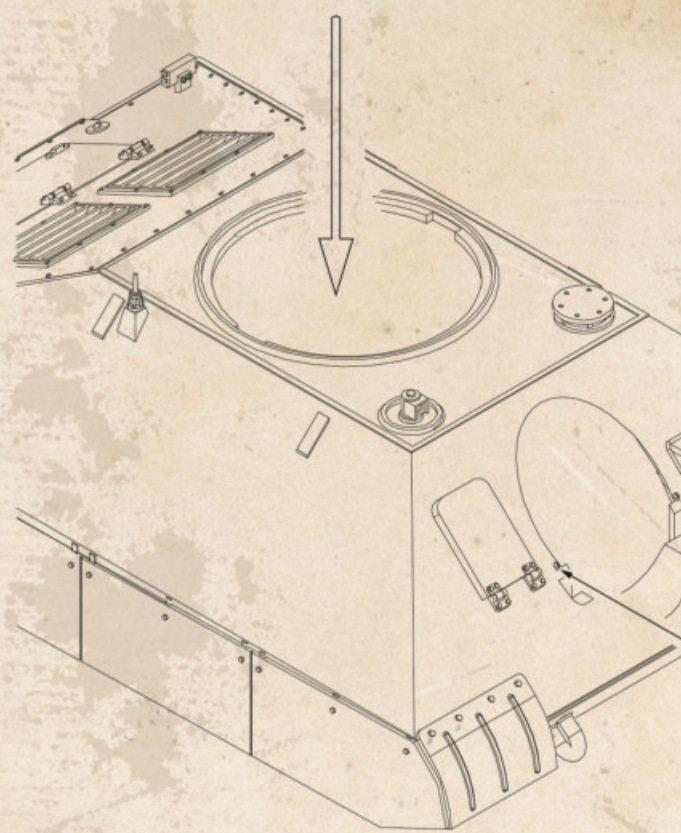
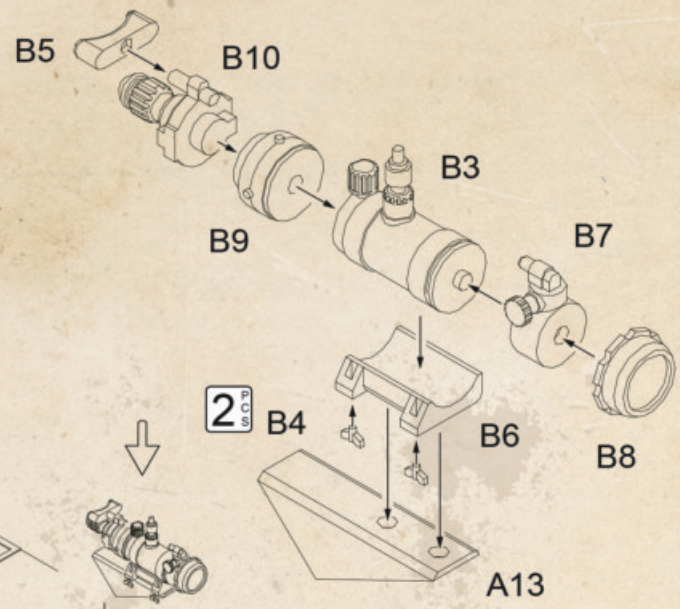
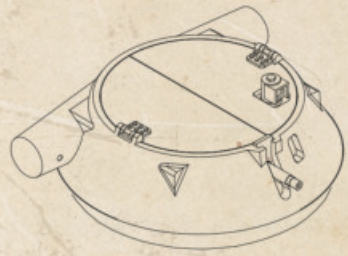
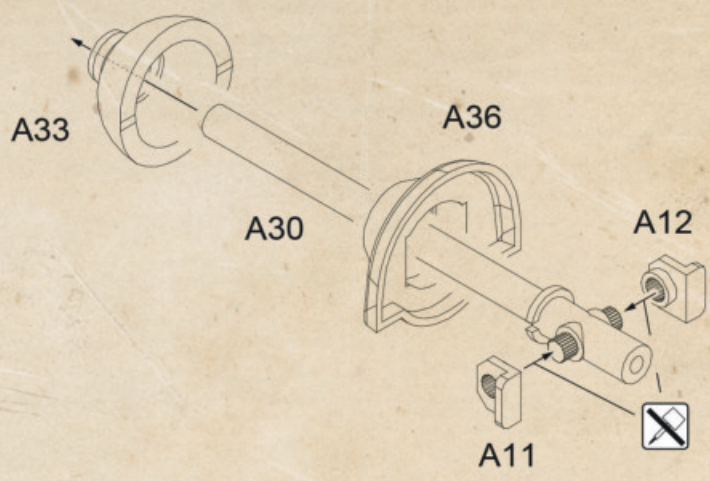

8 State:B
10cm PAW

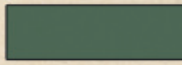

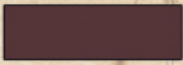
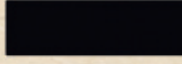
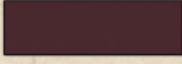
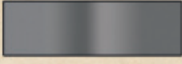

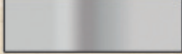

Painting and Marking Guide

	A.MIG-0004 RAL 6011B Resedagrün		A.MIG-0010 RAL 7028 Dunkelgelb (MID WAR)		A.MIG-0011 RAL 7028 Dunkelgelb Aus 44 DG I		A.MIG-0015 RAL 7028 Dunkelgelb Aus 44 DG I
	A.MIG-0035 Dark Tracks		A.MIG-0042 Old Rust		A.MIG-0045 Gun Metal		A.MIG-0096 Crystal Periscope Green
	A.MIG-0099 Crystal Black Blue		A.MIG-0010 Silver				

Unknown unit,
Germany 1945.

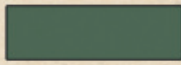

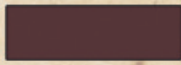
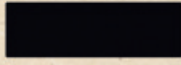
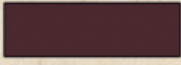
Painting and Marking Guide

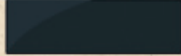
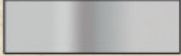
	A.MIG-0004 RAL 6011B Resedagrün		A.MIG-0010 RAL 7028 Dunkelgelb (MID WAR)		A.MIG-0012 RAL 7028 Dunkelgelb AUS '44 DG III		A.MIG-0015 RAL 7028 Dunkelgelb Aus '44 DG I
	A.MIG-0035 Dark Tracks		A.MIG-0042 Old Rust		A.MIG-0045 Gun Metal		A.MIG-0096 Crystal Periscope Green
	A.MIG-0099 Crystal Black Blue		A.MIG-0195 Silver				

Unknown unit,
Hamburg, Germany 1945.

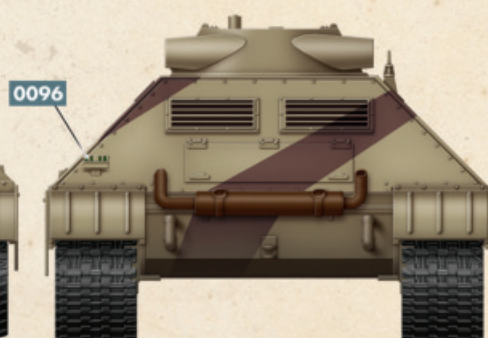
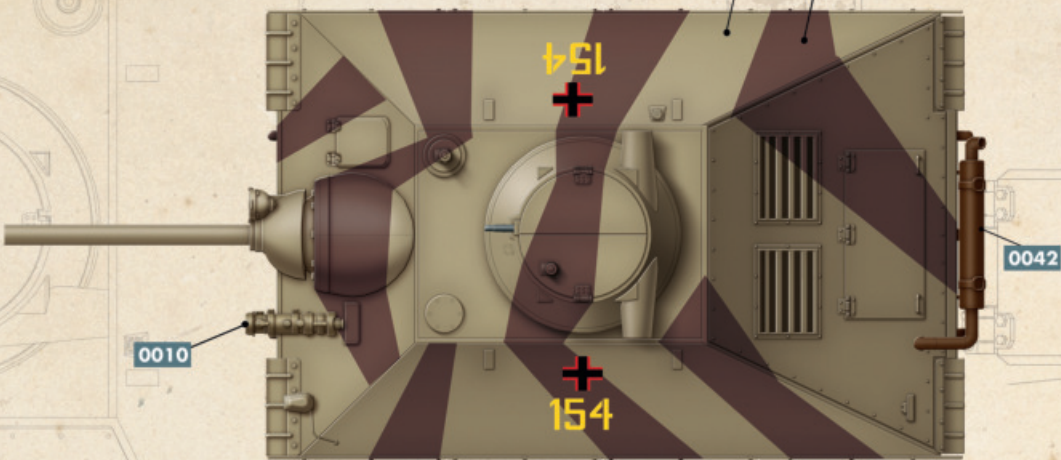

Painting and Marking Guide

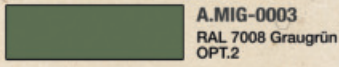

A.MIG-0003
RAL 7008 Graugrün
OPT.2

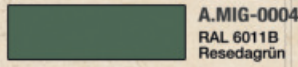

A.MIG-0004
RAL 6011B
Resedagrün



A.MIG-0012
RAL 7028 Dunkelgelb
AUS '44 DG III

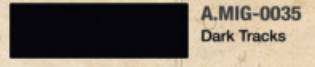

A.MIG-0035
Dark Tracks

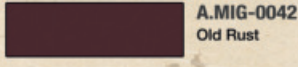

A.MIG-0042
Old Rust



A.MIG-0045
Gun Metal

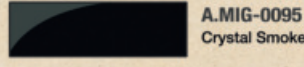

A.MIG-0095
Crystal Smoke

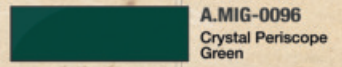

A.MIG-0096
Crystal Periscope
Green

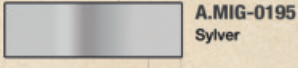



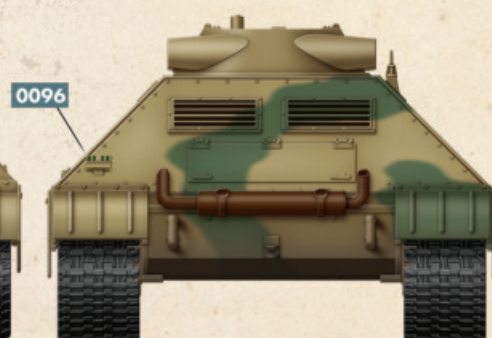
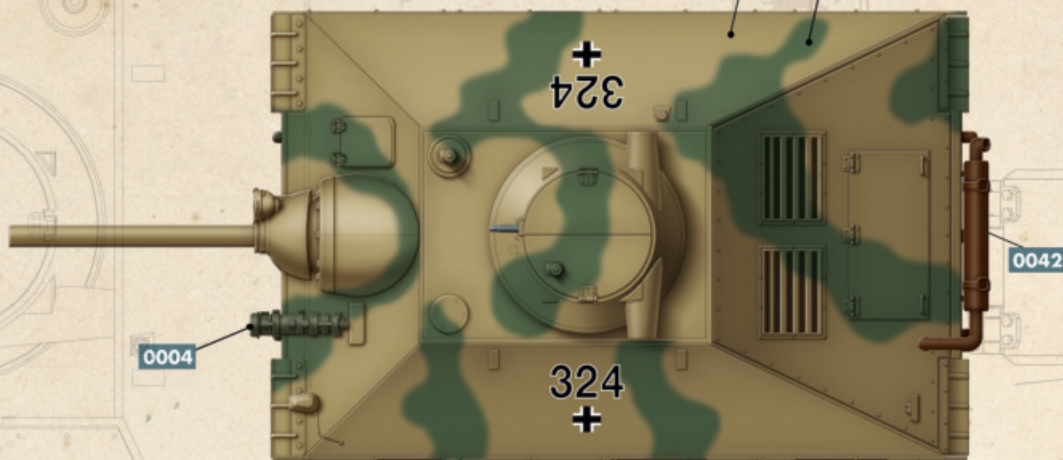

A.MIG-0195
Silver

Unknown unit,
Berlin, Germany 1945.

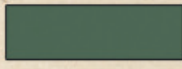
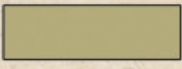

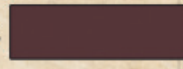
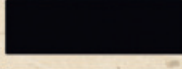
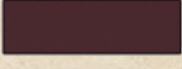
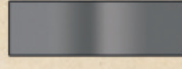
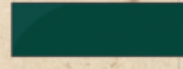
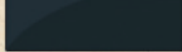

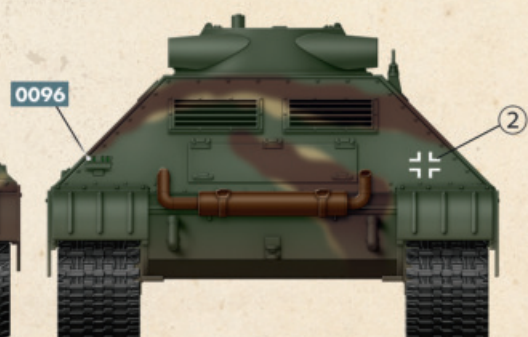

Painting and Marking Guide

	A.MIG-0004 RAL 6011B Resedagrün		A.MIG-0010 RAL 7028 Dunkelgelb (MID WAR)		A.MIG-0012 RAL 7028 Dunkelgelb AUS '44 DG III		A.MIG-0015 RAL 7028 Dunkelgelb Aus '44 DG I
	A.MIG-0035 Dark Tracks		A.MIG-0042 Old Rust		A.MIG-0045 Gun Metal		A.MIG-0096 Crystal Periscope Green
	A.MIG-0099 Crystal Black Blue		A.MIG-0195 Sylver				

Unknown unit,
Freudenstadt, Schwarzwald 1946.

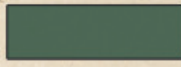
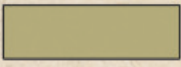
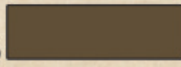
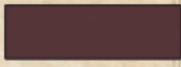
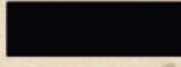
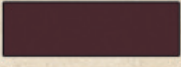

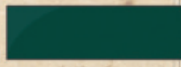
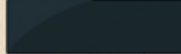
Painting and Marking Guide

	A.MIG-0004 RAL 6011B Resedagrün		A.MIG-0010 RAL 7028 Dunkelgelb (MID WAR)		A.MIG-0014 RAL 8012 Rotbraun		A.MIG-0015 RAL 7028 Dunkelgelb Aus'44 DG I
	A.MIG-0035 Dark Tracks		A.MIG-0042 Old Rust		A.MIG-0045 Gun Metal		A.MIG-0096 Crystal Periscope Green
	A.MIG-0099 Crystal Black Blue		A.MIG-0195 Silver				

Unknown unit,
Germany 1945

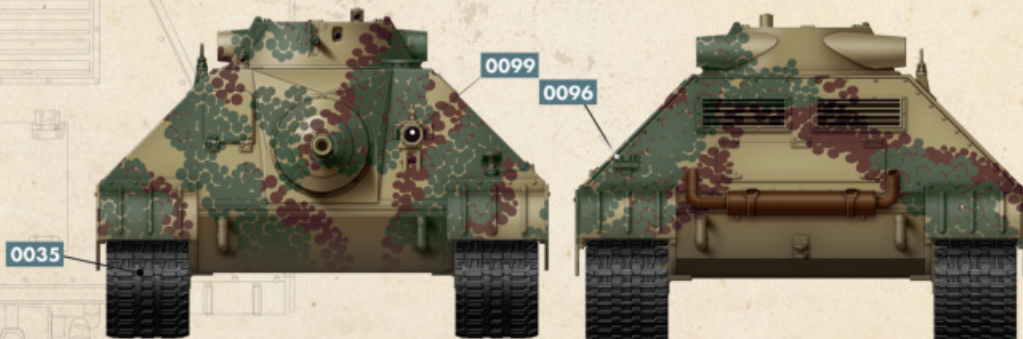
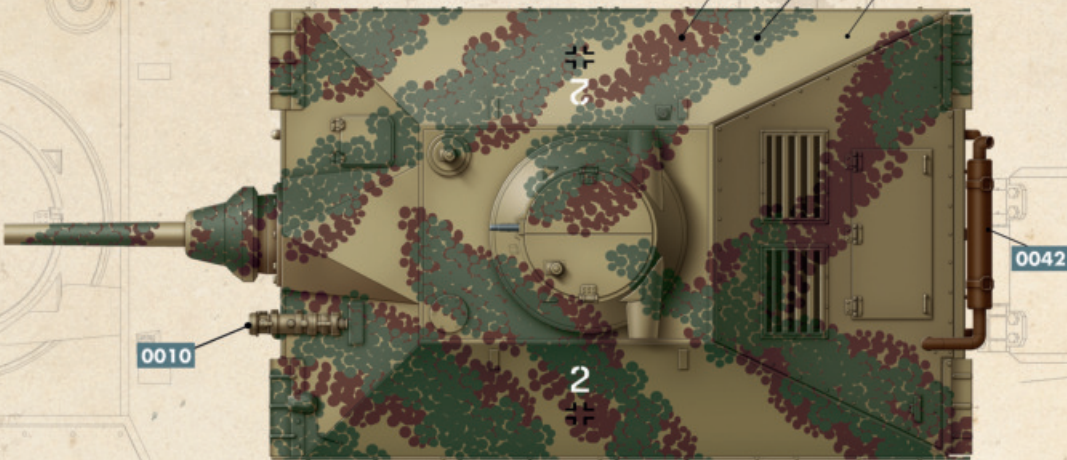

Painting and Marking Guide

	A.MIG-0004 RAL 6011B Resedagrün		A.MIG-0011 RAL 7028 Dunkelgelb AUS '44 DG 1		A.MIG-0014 RAL 8012 Rotbraun		A.MIG-0024 Washable White Camo
	A.MIG-0035 Dark Tracks		A.MIG-0042 Old Rust		A.MIG-0045 Gun Metal		A.MIG-0095 Crystal Smoke
	A.MIG-0096 Crystal Periscope Green		A.MIG-0195 Silver				

Unknown unit,
Germany Winter 1945/46

