

INSTRUCTIONS · BAUANLEITUNG · INSTRUCTIONS · INSTRUKTION · ISTRUZIONI  
 INSTRUCCIONES · MONTAGE ZOORSCHRIFTEN · KÄYTTÖOHJEET · BRUKSANVISNING

**SYMBOLS**

**SINNBILD**

**SYMBOLES**

**SYMBOL**

**SIMBOLI**

**SIMBOLOS**

**TEKEN**

**MERKKI**

**SYMBOLER**



Cement parts together.

Teile zusammenkleben.

Coller les pièces ensemble.

Limma ihop delarna.

Incollare le parti lúna con l'altra.

Pegue las partes.

Cementeer de delen samen.

Osat liimataan yhteen.

Sementer delene sammen.



Do not cement together.

Nicht zusammenkleben.

Ne pas coller ensemble.

Limma inte ihop delarna.

Non incollare le parti.

No pegue las partes.

Cementeer niet samen.

Osia ei liimata yhteen.

Ikke sementer delene sammen.



Make a choice.

Verschiedene baumöglichkeiten.

Choix de pièces fournies.

Dessa delar medföljer för valfri användning.

Diverse possibilità di montaggio.

Opcional.

Keuze van beschikbare onderdelen.

Osien käyttö valinnanvaraista.

Treff et valg.



Black · Schwarz · Noir · Svart · Nero · Negro · Zwart · Musta · Svart



Olive Green · Khaki · Grün · Vert-Olive · Olivgrön · Verde Oliva · Verde Oliva · Olijfgroen · Oliivivihreä · Olivengrönt



Brown · Braun · Brun · Brun · Marrone · Marron · Bruin · Ruskea · Brunt



Flesh · Hell Rosa · Couleur Chair · Hudfärg · Color Carne · Color de Piel · Huidkleur · Ihoväri · Kjød · Kjøtt



Light Blue · Hell Blau · Bleu Clair · Ljus Blå · Azzurro Luce · Azul Claro · Lichtblau · Vaalean Sininen · Lyseblått



Dark Blue · Dunkelblau · Couleur Bleu Foncé · Mörkblå · Bleu Scuro · Azul Oscuro · Donker Blauw · Tumman Sininen · Mørkeblå



Silver · Silber · Couleur Argent · Silver · Argento · Plate · Zilver · Hopeanvärinen · Sølv

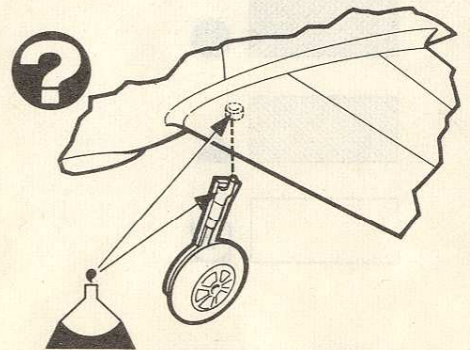
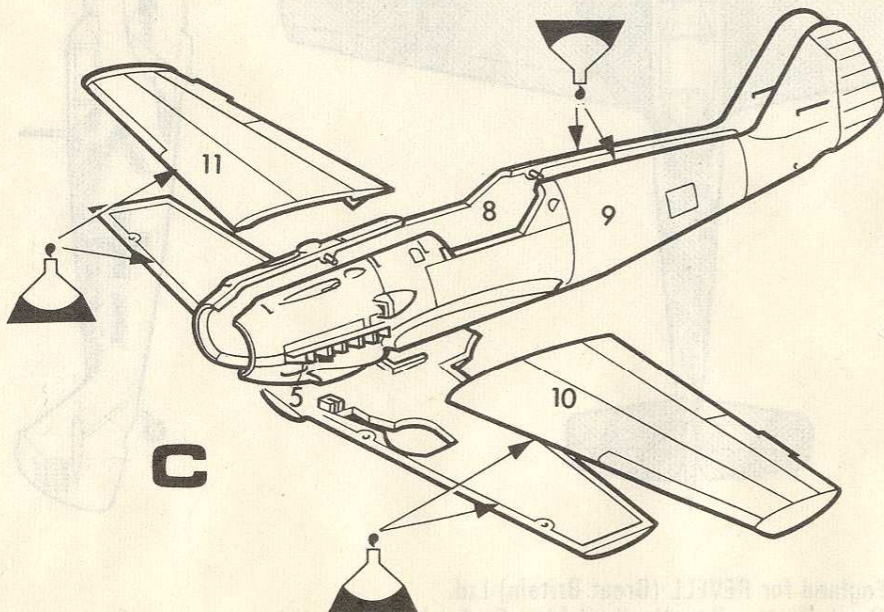
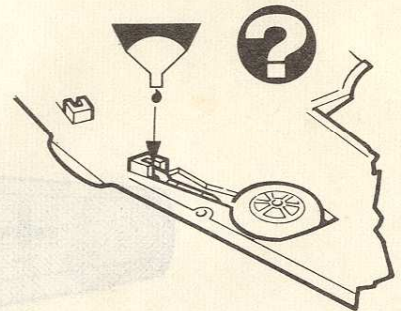
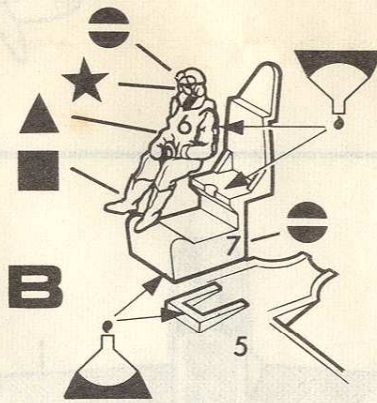
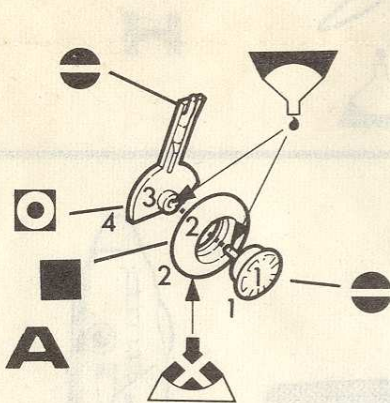



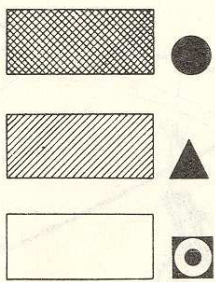
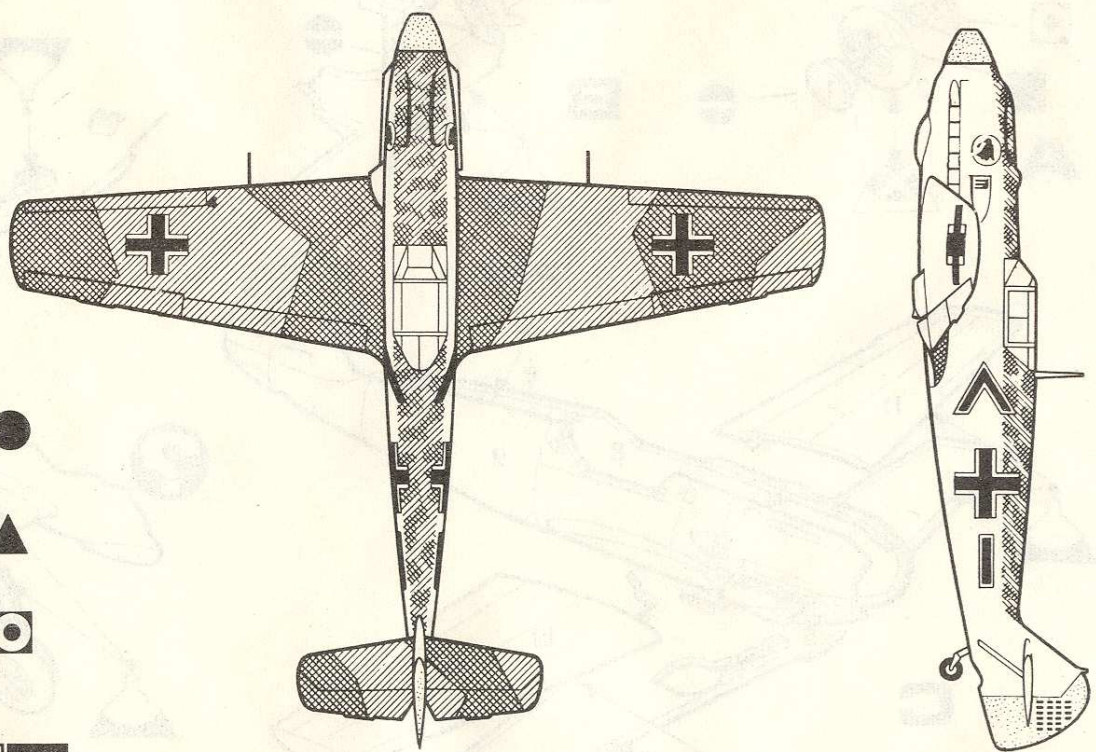
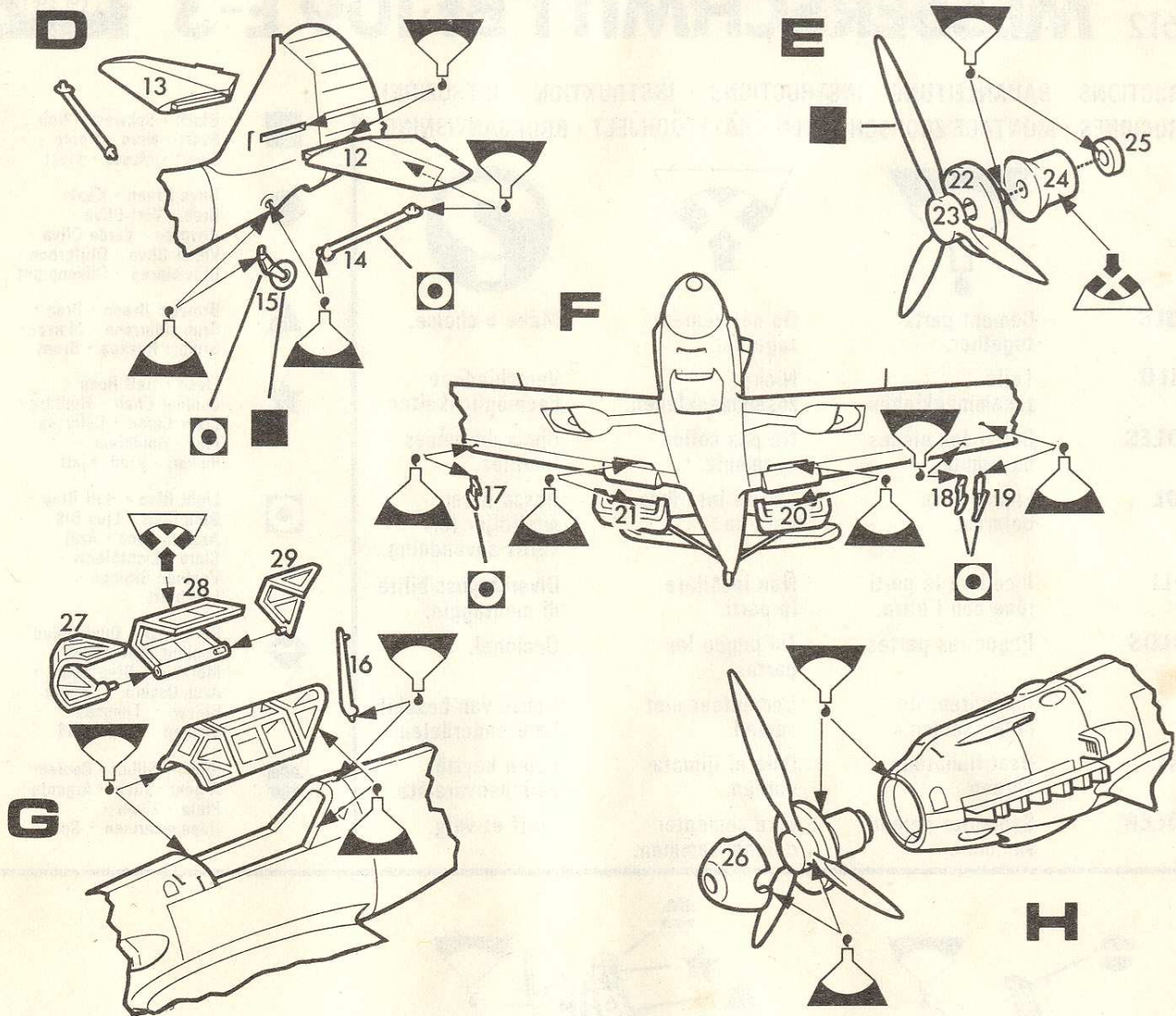

Printed in England for REVELL (Great Britain) Ltd.  
Cranborne Road, Potters Bar, Hertfordshire, England.