

MISTER
Hobby kits CRAFT



1:72

ART BY ADAM MARCINIAK

イラク空軍 ミグMiG-21MF

C-16

MiG-21MF 'Tomcat Killer'

Brief History of MiG-21: In the mid 60s there has been held further development recon version to typical to MiG-21 fighter purpose. In this time most modern soviet radar "Saphir" was placed into its nose starting third generation of MiG-21s. First batch named MiG-21S powered by R-11F2S-300 was soon replaced by MiG-21SM powered by R-13 F-300 engine and added underbelly canon GSz-23L. MiG-21S was exported under designation MiG-21M and MiG-21SM as MiG-21MF. Third generation MiGs-21 were the most numerous of total 10000 MiG-21 being build. Airplanes were operated by over 30 nations and 4000 of them remain still in service. Last version of MiG-21SM was MiG-21SMT having the biggest "hangbag" created by enlarging its fuselage fuel tanks. Licenced MiG-21M was build in India under designation HAL MiG-21M and MiG-21MF in China as J-7(III).

Technical data (MiG-21MF): Wingspan 7.15m. Length 15.76m, Height: 4.13m, Wing Area: 23m². Max Weight 9,800kg. Engine-R-13F-300 64,8kN. Fixed Armament: 1 X GSz 23mm two barrel cannons, External stores: 4x AA-2 missiles, non-guided rockets and bombs. Performance: Max speed: 2230 km/h (M=2,1). Range: 1440km, Service ceiling: 18 200m.

D. Geschichte des Jagdflugzeuges MiG-21: Mitte den 60-ten Jahren man begant die Produktion der dritte Generation die Flugzeugen MiG-21 in den erkenntnissen Versionen unter der Markierung "R" und "RF". Dann man anpasse ihm zu den Jagdanfgaben durch die Anwendung der neusten Radarstation "Saphir". MiG-21 S protuziert in der geringen Anzahl mit dem Motor R-11 wurde gefänscht gegen Version SM mit dem Motor R-13. Die Exportnamen der MiG-21 SM mind MiG-21 M mit dem Motor R-11 und MiG-21 MF mit dem Motor R-13. Die Fortsetzung des flugzeug MiG-21 SM ist MiG-21 SMT wer hat der großer Buskel von allen MiG-21. Die Flugzeug MiG-21M man produzierte in Indien unter der Markierung HAL MiG-21 M, und auch in China unter der Markierung J-7(III). Modernization der tschechen MiG sind MiG-21 MA und MiG-21 MFN. Die MiG-21 Flugzeuge nahmen in dem verschieden Kriege teil, das sind in Vietnam, in den arabischen-izraelischen Kriegeen und in den viele konflikten im Afrika.

tait lui à des tâches cynétiques à travers l'emploi de la plus modern station de radiolocation "Saphir". Est fabriqué dans plutôt petit nombre MiG-21S avec le moteur R-11 est resté change à la version "SM" pourvue dans les moteur R-13. Les nomes d'exportation MiG-21 SM ça MiG-21 M avec le moteur R-11, et MiG-21 MF avec le moteur R-13. Prolongment de l'avion MiG-21SM est MiG-21 SMT la possédante bosse le plus grande avec tous MiG-ce 21. L'avions MiG-21 M on produisait en Indes sous la qualification HAL MiG-21 M et anssi en Chines sous la qualification J-7(III). Les modernisations des tcheques MiG-ce ça MiG-21 MA et MiG-21 MiG-21 MFN. L'avions MiG-21 prenaient part à beaucoup guerres c'est en Vietnam, a guerres arabiques-izraeliers et beoucoup conflicts en Afrique en étant sur l'équipement audeussus 30 d'etats.

Caractéristiques techniques: Envergure: 7,44m, Longuer 15,76, Hauteur: 4,125, Vitesse maximale 2330 km/h (M=2,1), Plafond 17300m, Distance franchissable 1440 km. Armement fixe: de deux doubles canons GSz-23L 23 mm sous son fuselage, 4 x missile R-3S.

PL. Historia MiG-21. W polowie lat 60-ych rozpoczęto produkcję trzeciej generacji samolotów MiG-21 w wersjach rozponawczych tj. R, RF. Następnie przystosowano go do zadań myśliwskich poprzez zastosowanie najnowocześniejszej stacji radiolokacyjnej Saphir. Wyprodukowany w niewielkiej ilości MiG-21S z silnikiem R-11F2S-300 został zamieniony wersją SM wyposażoną w silnik R-13 F-300 i umieszczonym pod kadłubem na stałe działkiem GSz-23L. Nazwy eksportowe MiG-21SM to MiG-21M z silnikiem R-11 oraz MiG-21MF z silnikiem R-13F-300. Kontynuacją samolotu MiG-21SM to SMT posiadający największy garb z MiGów-21. Samoloty MiG-21M produkowano w Indiach pod oznaczeniem HAL MiG-21M, a także w Chinach gdzie był oznaczony J-7(III).

Dane lotno-techniczne: Rozpiętość: 7,15 m. Długość: 15,76 m. Wysokość: 4,13 m. Pow skrzydła: 23m². Max. masa startowa: 9,800kg. Silnik R-13F-300 o ciągu max. 64,8 kN. Uzbrojenie stałe: działko Gsh-23 23 mm. Uzbrojenie podwieszane: 4 rakiety R-13, niekierowane pociski rakietowe lub bomby. Prędkość max 2230km/h Pułap 18200m. Zasięg:

Numbers of parts • Numerung der Teile
 • Numeracja części • Číslování částí
 • Numérotation du pièces

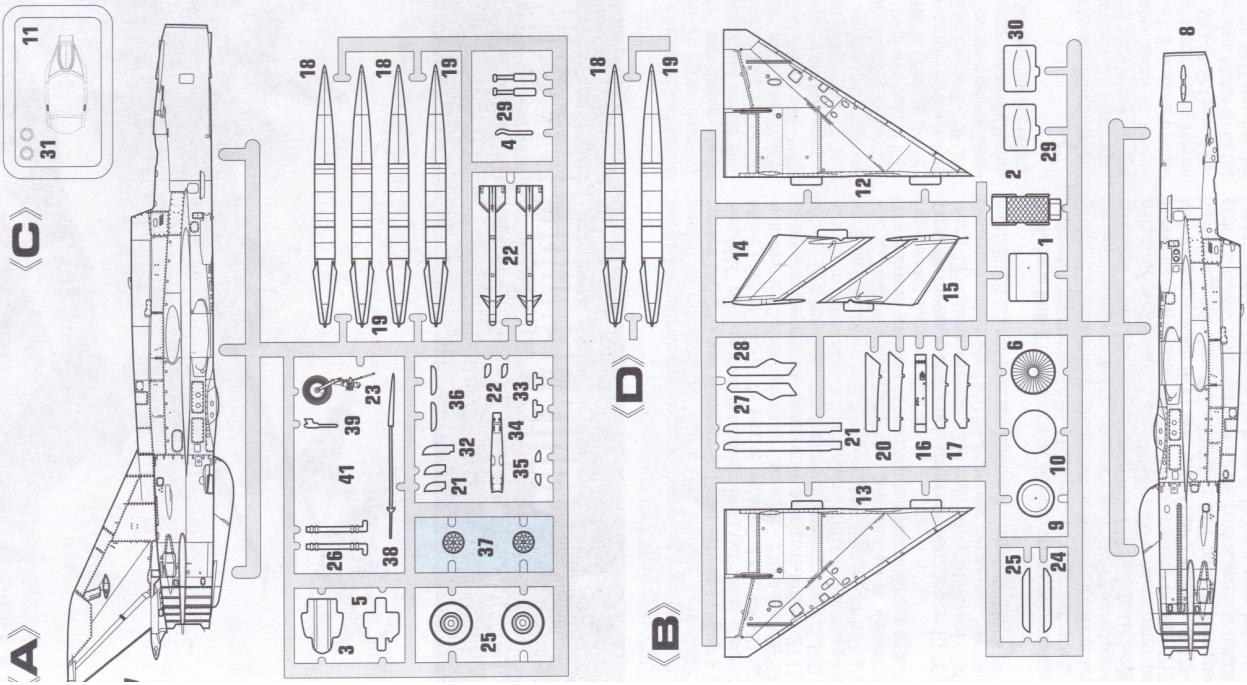

Parts not for use.
 Teile werden nicht verwendet.
 Pieces a ne pas utiliser.
 Parti non per uso.
 Darfoc nã se utiliza.

“WARNING” FUNCTIONAL SHARP POINTS
“WARNING” SCHARFE ECKEN UND KANTEN
“VERTICE” POINTS ESSENTIELS DE FONCTIONNEMENT
“ATTENZIONE” PARTI MOLTO ACUMINATE

Assembly Instruction

• Instrukcja montażu
 • Baunleitu
 • Montage
 • Stavební

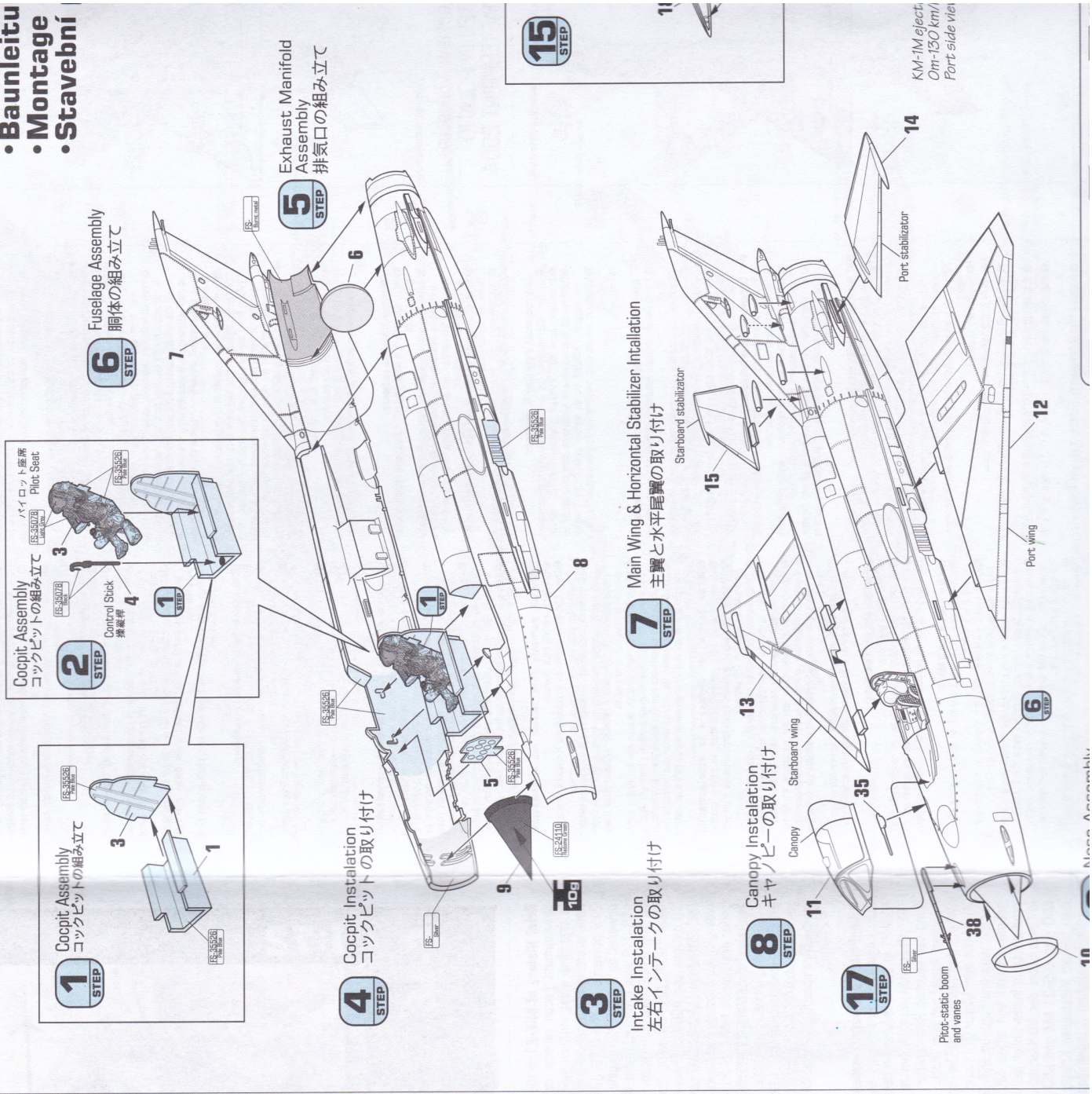

KM-1M eject
 Om-130 km/
 Port side vie

II. Serie 1/72 airplanes:

1. Yak-1 "Soviet aces"
2. Yak-1 "Luftwaffe"
3. Yak-1 "Normandie"
4. Yak-1 "Yak-1b"
5. Il-2 "Gorbati" -5001
6. Il-2 "Luftwaffe" -5001
7. Il-2M "Sturmovik"
8. Il-2m3 "Der Schwarz Tod"
9. AH-1G "Vietnam War"
10. AH-1G "Plazboy"
11. AH-1G "Soogar Scoop"
12. AH-1G "Marines"

III. Serie 1/72 airplanes:

13. Fw-190 A-4
14. Fw-190 A-5 "Channel Coast"
15. Fw-190 A-6 "Grün Hertz"
16. Fw-190 A-7 "JG-1"
17. Fw-190 A-8 "Rammiäger"
18. Fw-190 A-8R8 "Sturmbock"
19. Fw-190 F-2 "Schlachtflugzeuge"
20. Fw-190 F-8
21. Fw-190 D-9 "Michaelisk"
22. Fw-190 D-9 "Rudel"
23. Fw-190 D-9 "Papegein Staffel"
24. Fw-190 D-9 "Langrasen"
25. MiG-21S "Czechoslowakia '68"
26. MiG-21SM "303 GAD"
27. MiG-21M "German MiG" -5001
28. MiG-21MA "Pin up girl"
29. MiG-21MF "F-14 Killer"
30. MiG-21MF "Grey MiG" -5001
31. P-51B-1 "Bull Frog"
32. P-51B-1 "The Diakon"
33. P-51B-5 "Ding Hao"
34. P-51B-5 "Bee"
35. P-51B-7 "Shangri-La"
36. P-51B-15 "Bald Eagle"
37. P-51C-1 "Lopez Hope"
38. P-51C-10 "Glady's"

IV. Serie 1/72 airplanes:

39. Su-17M2 "Ural Guardian" -5001
40. Su-17M3 "Afghanistan War" -5001
41. Su-17M3R "Recon Fitter"
42. Su-17M4 "Fitter K"
43. Su-17/22UM-3K
44. Su-20/R "Last Flight"
45. Su-22M2 "Los Tigres"
46. Su-22M3 "Gulf of Sora Conflict"
47. Su-22M4 "77 JBG"
48. Su-22M4/R "Desert Storm"
49. PZL P-37A "Loś II"
50. PZL P-37A bis "Los Luftwaffe"
51. PZL P-37B "Loś II"
52. PZL P-37A "VVS & FARR"

Ejection Seat KM-1M

RESTRAINT OF HAND

FAIRING HANDLE



10 STEP Main Landing Gear Assembly 主脚の組み立て



10 STEP
Cut and bend
Naczej i zgięć

12 STEP Nose Gear Installation 前脚の取り付け

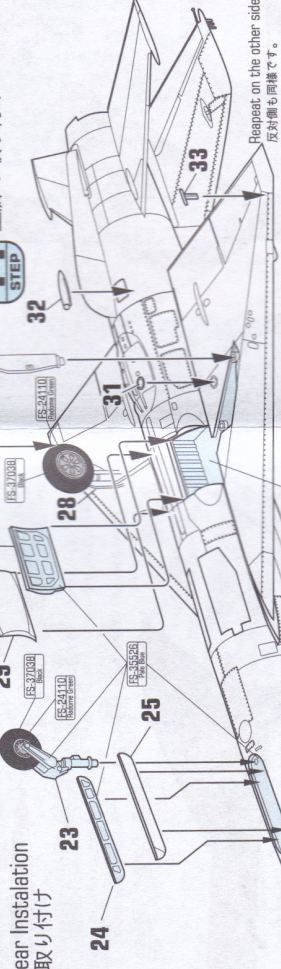

10 STEP Repeat on the other side
反対側も同様です。

11 STEP Main Gear Installation 主脚の取り付け

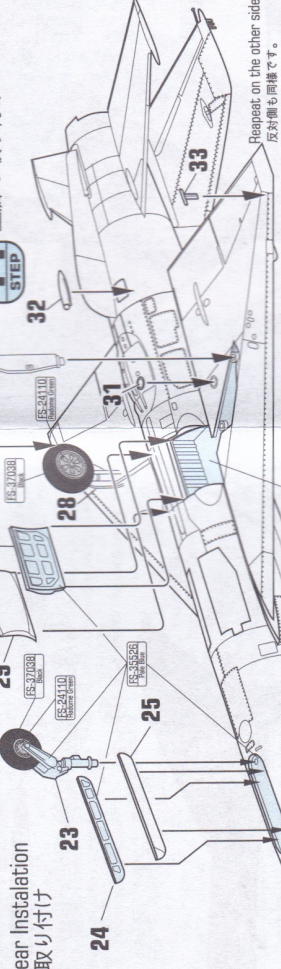

Repeat on the other side
反対側も同様です。

2x NUMBER OF WORKING STEPS
ANZAHL DER ARBEITSSTÄNDE
NOMBRE DE PASSES
NUMERO DI PASSAGGI
NUMERO DE OPERACIONES DE TRABAJO
ILUSK, TANCH, SAMWICH OPERACI
HET AANTAL DER BOUWHANDLINGEN
OPAKOVANI OPERACE

16 STEP Auxiliary Fuel Tank PTB-490 Assembly 増槽タンクの組み立て

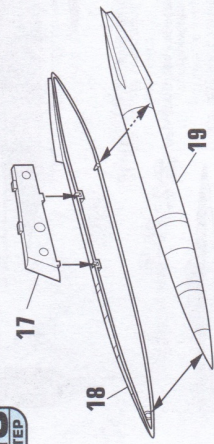

17 STEP Auxiliary Fuel Tank PTB-490 Assembly 増槽タンクの組み立て

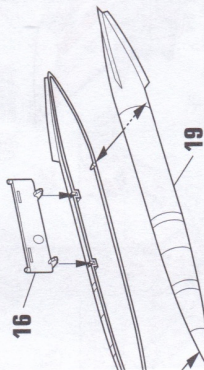

14 STEP R-3S Missile Installation ミサイルの取り付け

2x NUMBER OF WORKING STEPS
ANZAHL DER ARBEITSSTÄNDE
NOMBRE DE PASSES
NUMERO DI PASSAGGI
NUMERO DE OPERACIONES DE TRABAJO
ILUSK, TANCH, SAMWICH OPERACI
HET AANTAL DER BOUWHANDLINGEN
OPAKOVANI OPERACE

R-3S IR guided AAM
Port-side view
scale 1/72nd

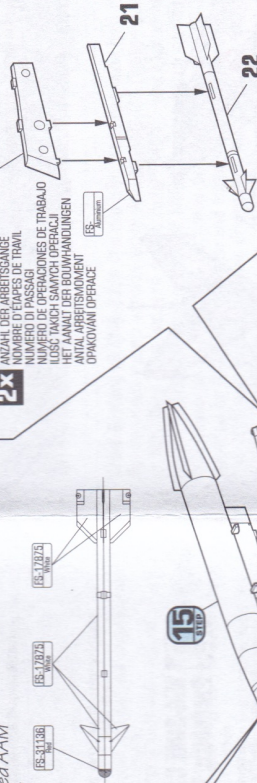

17 STEP Auxiliary Fuel Tank Installation 増槽タンクの取り付け

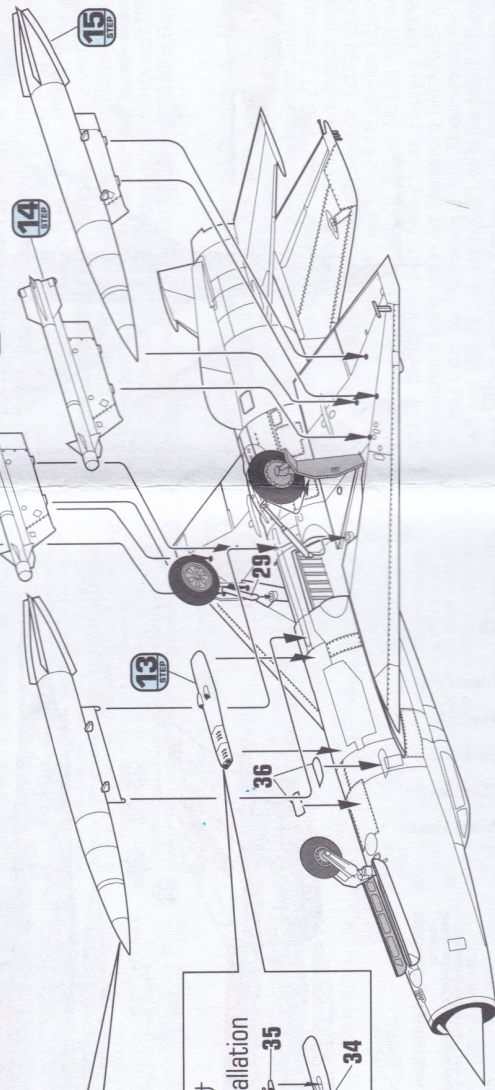

13 STEP Various Parts Installation 各部品の取り付け

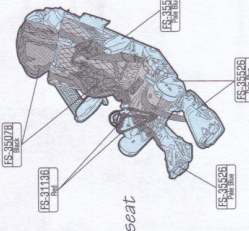
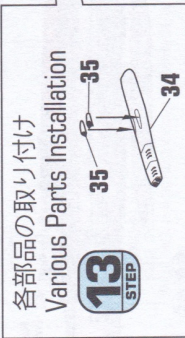

Marking & Painting

Markierungen und Bemalung Decoracion et Peinture Marchio & Pittura

Decoracion z Pintura Malowanie i Oznakowanie Označení a Kamufliá

Luftwaffe 23 + 15 (ex 5101) a/no.8615 Holzdorf A.B. Germany 1990.

1 MiG-21MF Iraqi Air Force (F-14 killer) Iraqi-Iran War, Iraq 1984

■ Airplane v/n 712 in desert camouflage painting scheme.
■ Airplane v/n 712 is recognized to shoot down one F-14A Tomcat during Iran-Iraq War.

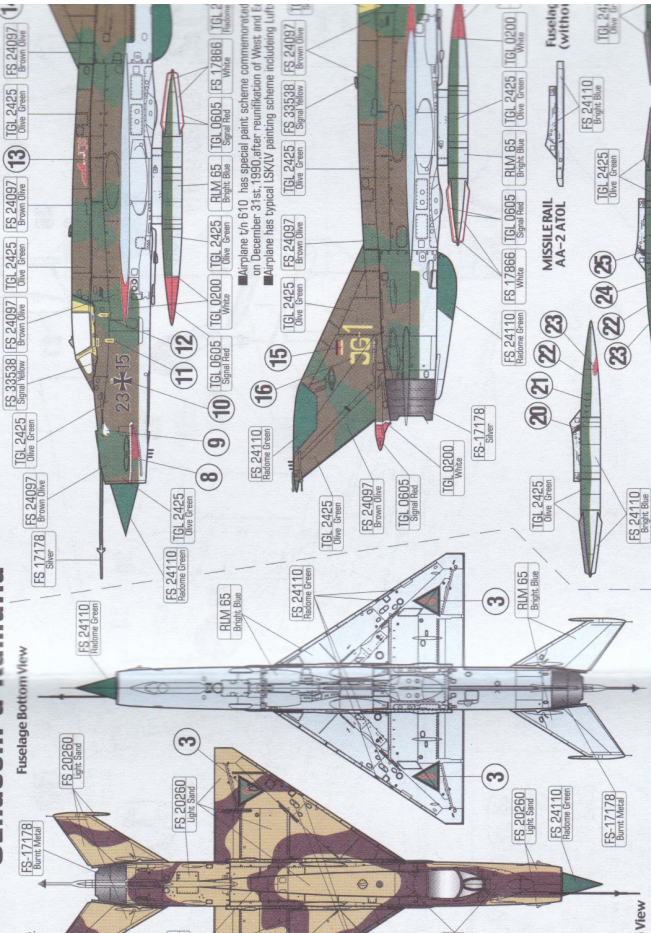

2 MiG-21MF 4th Fighter Reg. Polish Air Force Malbork A.B., Poland, 1984

■ Left side fuselage (без крыла)
■ Right side fuselage (без крыла)

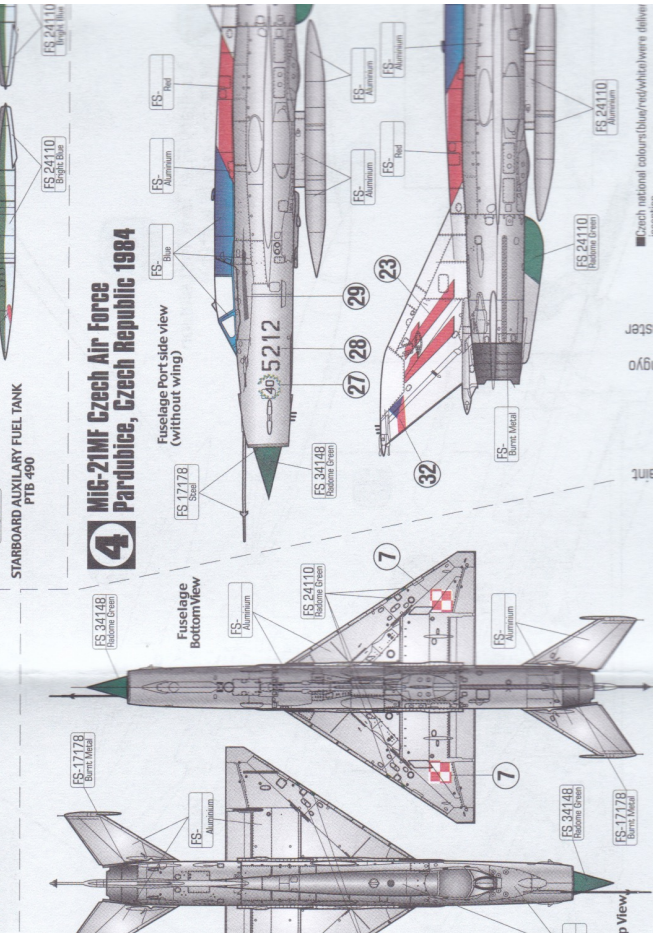

4 MiG-21MF Czech Air Force Pardubice, Czech Republic 1984

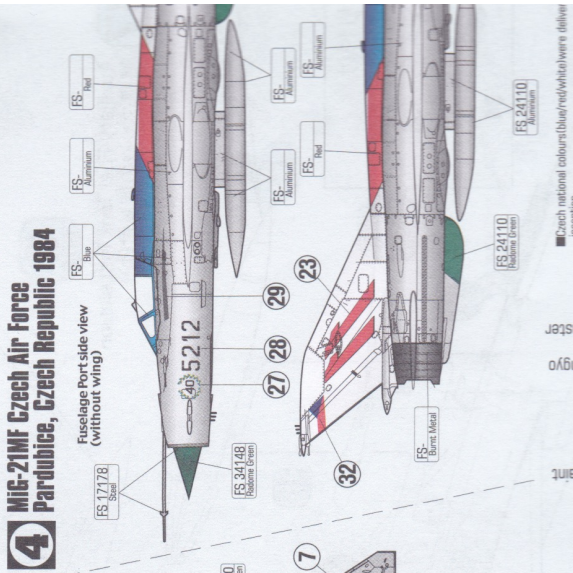

■ Airplane v/n 9110 in natural metal.
■ Regimental badge of 41 Fighter Regiment. ® - painted on both sides of fuselage.

FS	PL	CZ	GB	D	F	ESP	JAP	PL	CZ	GB
Master Paint	Humbrol	Gunze Sangyo	Model Master	PL	BIALY	WHITE	WEISS	BIANCO	BLANC	BIANCO
FS	PL	CZ	GB	D	F	ESP	JAP	PL	CZ	GB
Master Paint	Humbrol	Gunze Sangyo	Model Master	PL	BIALY	WHITE	WEISS	BIANCO	BLANC	BIANCO
FS	PL	CZ	GB	D	F	ESP	JAP	PL	CZ	GB
Master Paint	Humbrol	Gunze Sangyo	Model Master	PL	BIALY	WHITE	WEISS	BIANCO	BLANC	BIANCO
FS	PL	CZ	GB	D	F	ESP	JAP	PL	CZ	GB
Master Paint	Humbrol	Gunze Sangyo	Model Master	PL	BIALY	WHITE	WEISS	BIANCO	BLANC	BIANCO

Correct Assembly Instruction

GB Correct assembly instruction
 D Korrekte Montageanleitung
 PL Prawidłowa instrukcja montażu
 F Instructions de montage correctes
 Nl. Correcte montage instructie
 ESP Instrucciones de montaje correctas
 POR Instrução de montagem correta
 I Istruzioni di montaggio corrette
 S Korrekt monteringsanvisning
 Fin Oikea asennusohje
 DK Korrekt monteringsvejledning
 Nor Riktig monteringsanvisning
 Rus Правильная инструкция по сборке
 GR Σωστή οδηγία συναρμολόγησης
 Tur Doğru montaj talimatı
 Cz Správný montážní návod
 H Helyes összeszerelési utasítás
 Sk Správny montážny návod
 Rom Instrucțiunile de asamblare corecte
 Bg Правилна инструкция за монтаж
 UA Правильна інструкція по збірці
 Jap 正しい組み立て手順

GB Correct assembly instruction
 D Korrekte Montageanleitung
 PL Prawidłowa instrukcja montażu
 F Instructions de montage correctes
 Nl. Correcte montage instructie
 ESP Instrucciones de montaje correctas
 POR Instrução de montagem correta
 I Istruzioni di montaggio corrette
 S Korrekt monteringsanvisning
 Fin Oikea asennusohje
 DK Korrekt monteringsvejledning
 Nor Riktig monteringsanvisning
 Rus Правильная инструкция по сборке
 GR Σωστή οδηγία συναρμολόγησης
 Tur Doğru montaj talimatı
 Cz Správný montážní návod
 H Helyes összeszerelési utasítás
 Sk Správny montážny návod
 Rom Instrucțiunile de asamblare corecte
 Bg Правилна инструкция за монтаж
 UA Правильна інструкція по збірці
 Jap 正しい組み立て手順

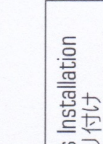
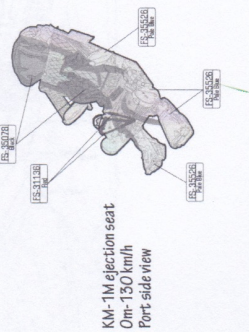
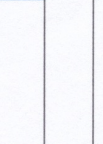
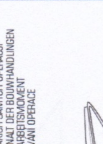
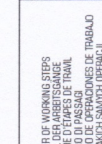
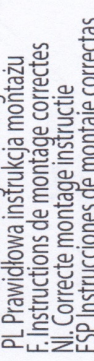
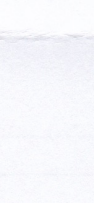
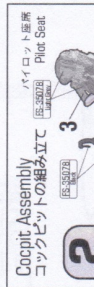
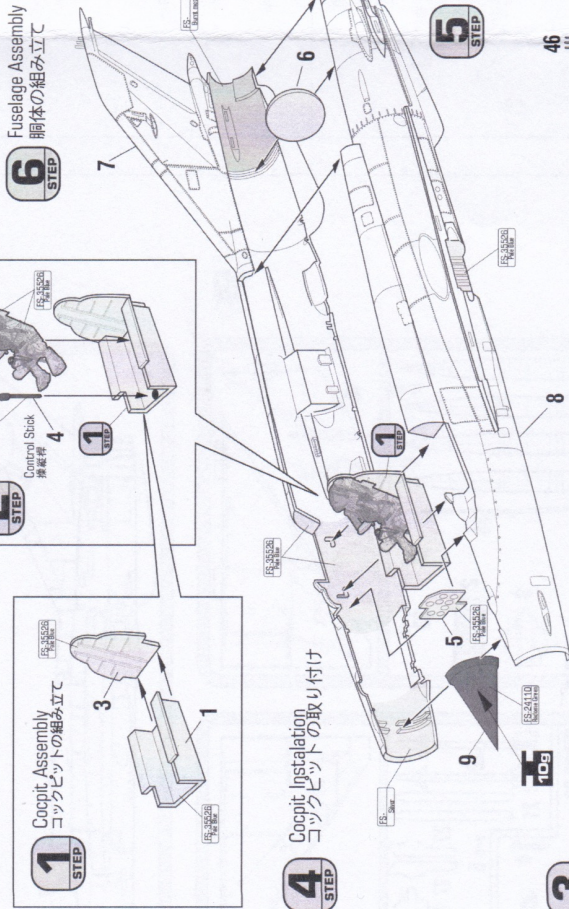
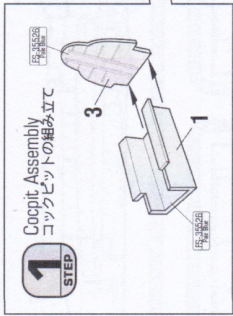
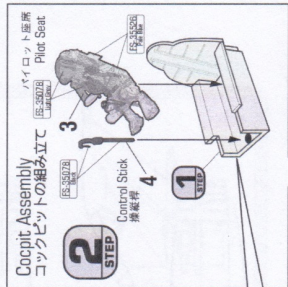

GB Correct assembly instruction
 D Korrekte Montageanleitung
 PL Prawidłowa instrukcja montażu
 F Instructions de montage correctes
 Nl. Correcte montage instructie
 ESP Instrucciones de montaje correctas
 POR Instrução de montagem correta
 I Istruzioni di montaggio corrette
 S Korrekt monteringsanvisning
 Fin Oikea asennusohje
 DK Korrekt monteringsvejledning
 Nor Riktig monteringsanvisning
 Rus Правильная инструкция по сборке
 GR Σωστή οδηγία συναρμολόγησης
 Tur Doğru montaj talimatı
 Cz Správný montážní návod
 H Helyes összeszerelési utasítás
 Sk Správny montážny návod
 Rom Instrucțiunile de asamblare corecte
 Bg Правилна инструкция за монтаж
 UA Правильна інструкція по збірці
 Jap 正しい組み立て手順

GB Correct assembly instruction
 D Korrekte Montageanleitung
 PL Prawidłowa instrukcja montażu
 F Instructions de montage correctes
 Nl. Correcte montage instructie
 ESP Instrucciones de montaje correctas
 POR Instrução de montagem correta
 I Istruzioni di montaggio corrette
 S Korrekt monteringsanvisning
 Fin Oikea asennusohje
 DK Korrekt monteringsvejledning
 Nor Riktig monteringsanvisning
 Rus Правильная инструкция по сборке
 GR Σωστή οδηγία συναρμολόγησης
 Tur Doğru montaj talimatı
 Cz Správný montážní návod
 H Helyes összeszerelési utasítás
 Sk Správny montážny návod
 Rom Instrucțiunile de asamblare corecte
 Bg Правилна инструкция за монтаж
 UA Правильна інструкція по збірці
 Jap 正しい組み立て手順

CORRECT MIG-21 NUMBERING OF PARTS

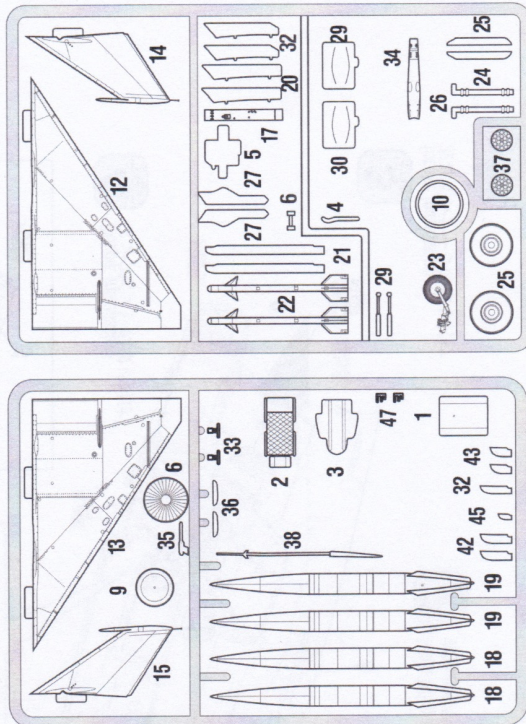
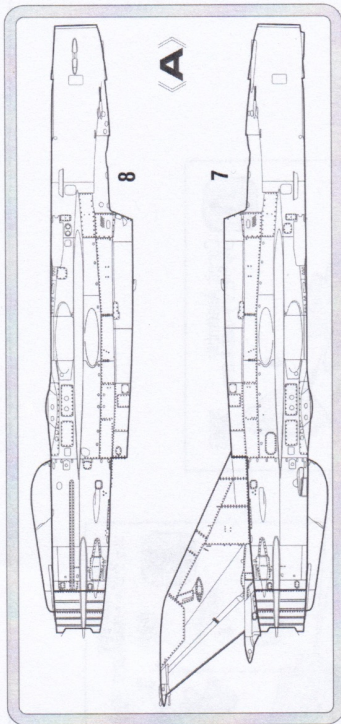

C
MisterCraft
Michał Maleszka
Nowica 1E
56-410 Dobroszyce
POLAND

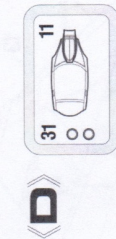

Parts not used
Nicht benutzte Teile
Elementy niepotrzebne
Piese non utilizzate
Niet benodigde onderdelen
Pezas no utilizadas
Parti non usate
Itele anevindate debar
Tarpometom ost
Ilike noovervridge dele
Deler som ikke er nødvendige
Неиспользуемые детали
Geneks parczal
Nepotrebne diely
Teil nem hasznalt
Neni obuzano
Части, които не се използват
Частини не використовуються

UK: Please note the enclosed safety advice and keep safe for later reference.
D: Bitte lesen Sie die Sicherheitsanweisungen und bewahren Sie sie für den Notfall auf.
E: Please read the enclosed safety advice and keep safe for later reference.
F: Veuillez lire attentivement les instructions de sécurité et les conserver précieusement.
G: Please read the enclosed safety advice and keep safe for later reference.
H: Veuillez lire attentivement les instructions de sécurité et les conserver précieusement.
I: Please read the enclosed safety advice and keep safe for later reference.
J: Please read the enclosed safety advice and keep safe for later reference.
K: Please read the enclosed safety advice and keep safe for later reference.
L: Please read the enclosed safety advice and keep safe for later reference.
M: Please read the enclosed safety advice and keep safe for later reference.
N: Please read the enclosed safety advice and keep safe for later reference.
O: Please read the enclosed safety advice and keep safe for later reference.
P: Please read the enclosed safety advice and keep safe for later reference.
Q: Please read the enclosed safety advice and keep safe for later reference.
R: Please read the enclosed safety advice and keep safe for later reference.
S: Please read the enclosed safety advice and keep safe for later reference.
T: Please read the enclosed safety advice and keep safe for later reference.
U: Please read the enclosed safety advice and keep safe for later reference.
V: Please read the enclosed safety advice and keep safe for later reference.
W: Please read the enclosed safety advice and keep safe for later reference.
X: Please read the enclosed safety advice and keep safe for later reference.
Y: Please read the enclosed safety advice and keep safe for later reference.
Z: Please read the enclosed safety advice and keep safe for later reference.

GB Correct assembly instruction
D: Korrekte Montageanleitung
PL Prawidłowa instrukcja montażu
F: Instructions de montage correctes
Nl: Correcte montage instructie
ESP Instrucciones de montaje correctas

