

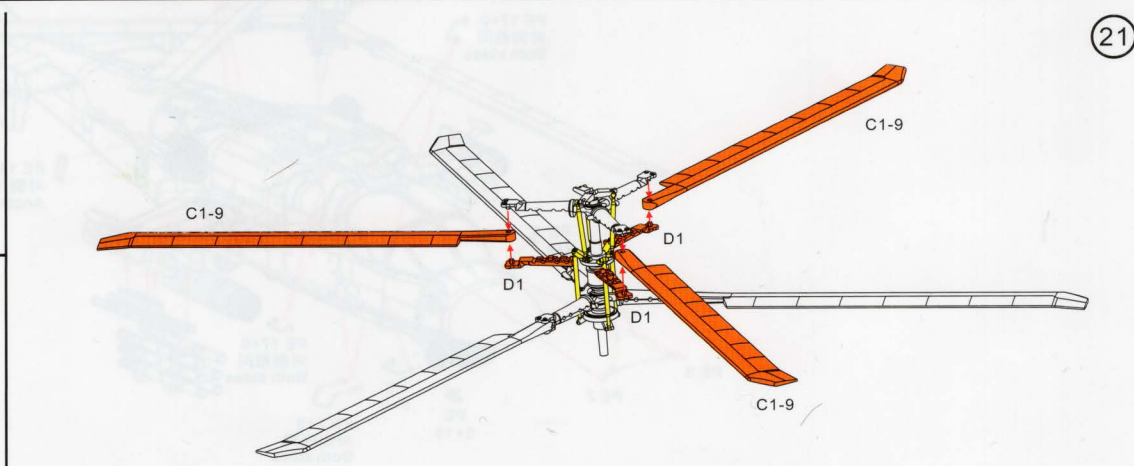

Russia Attack Helicopter Ka-52

俄罗斯 Ka-52 攻击直升机

DM 720024

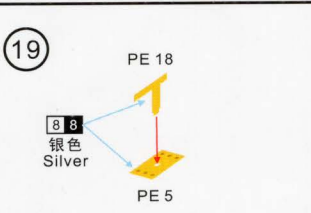
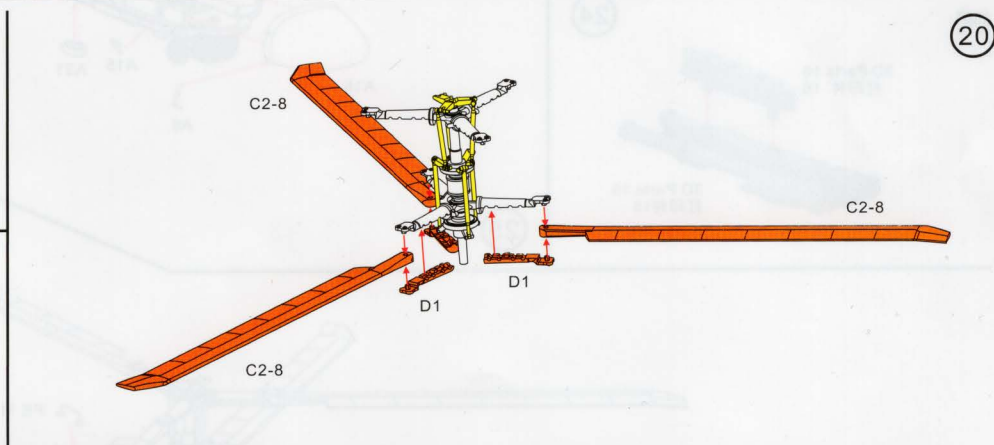
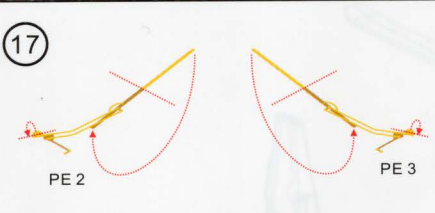
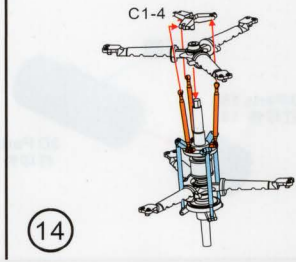
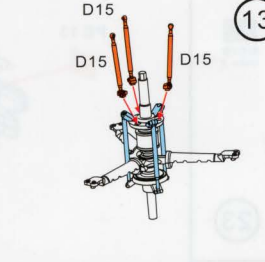
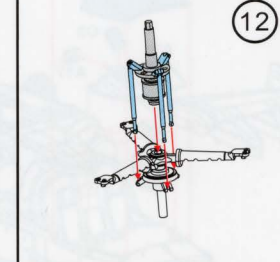
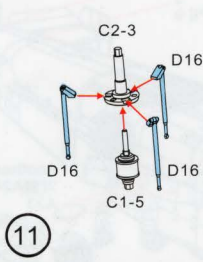
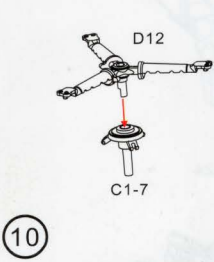
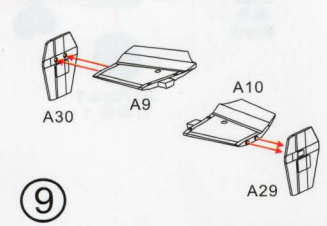
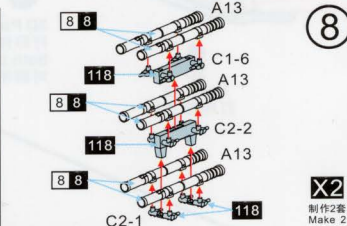
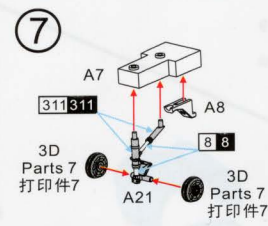
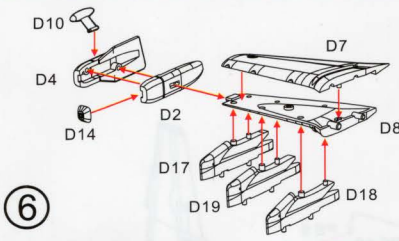
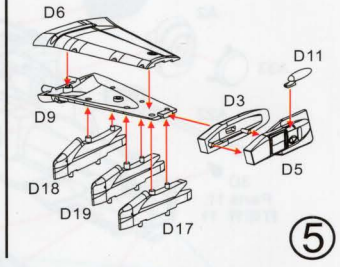
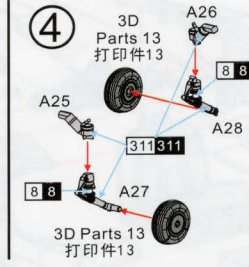
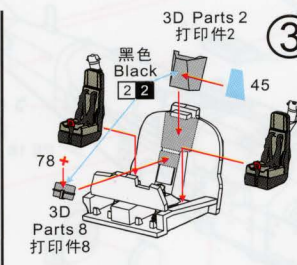
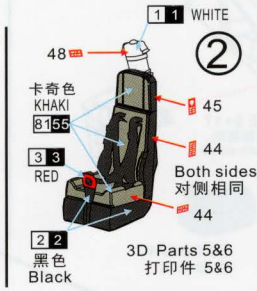
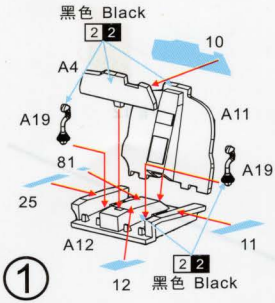

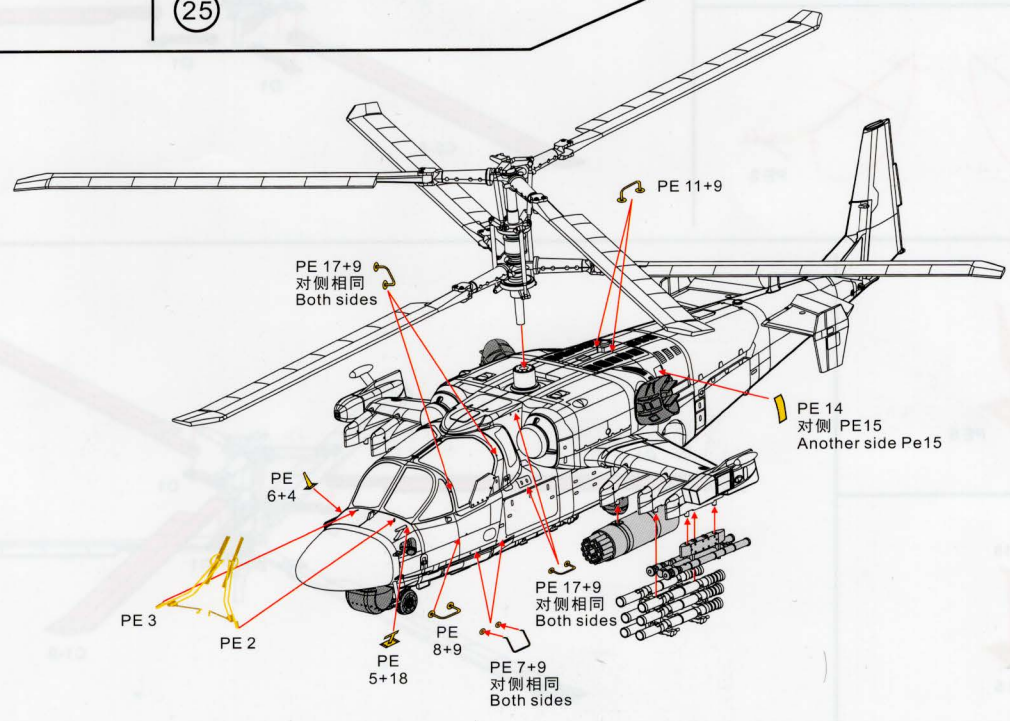
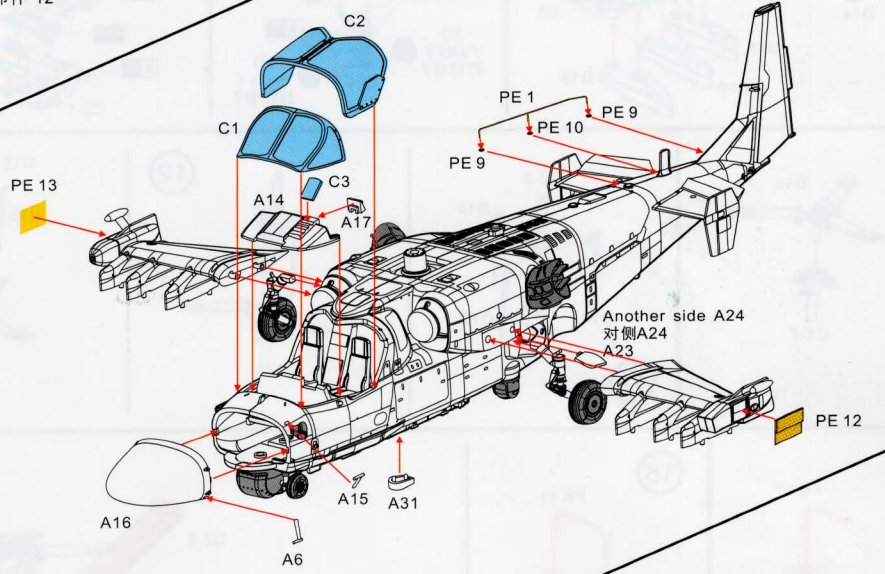
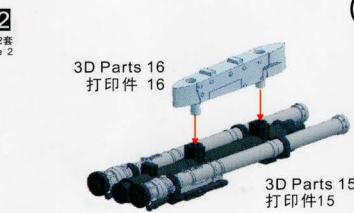
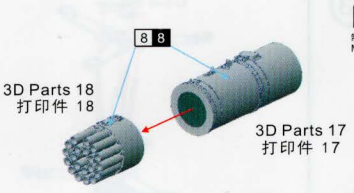
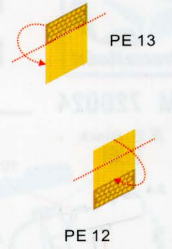
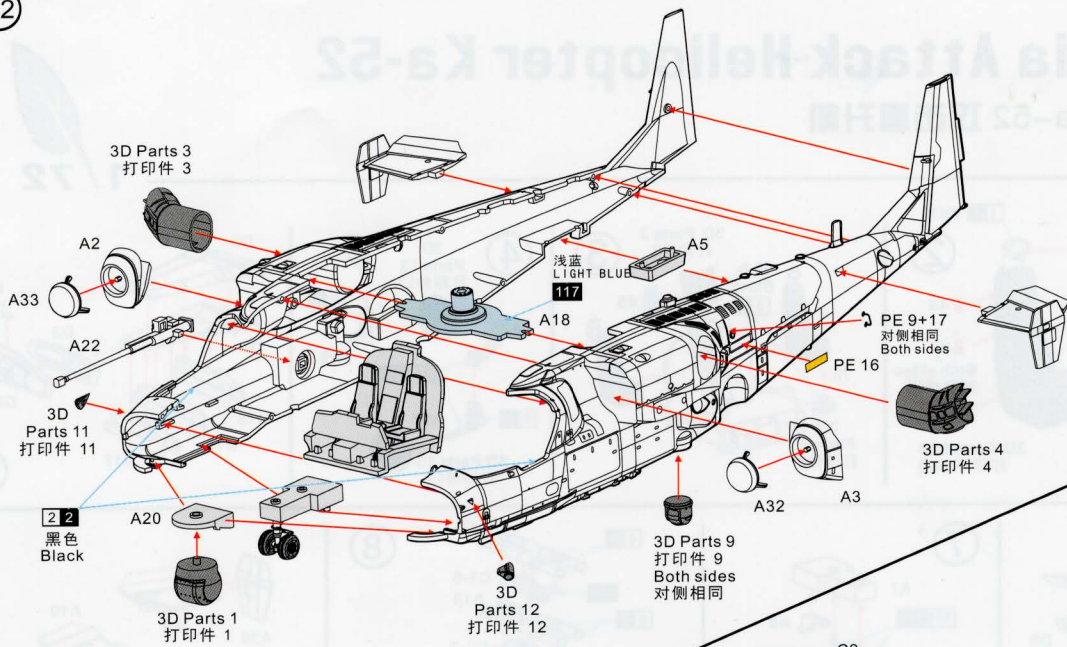

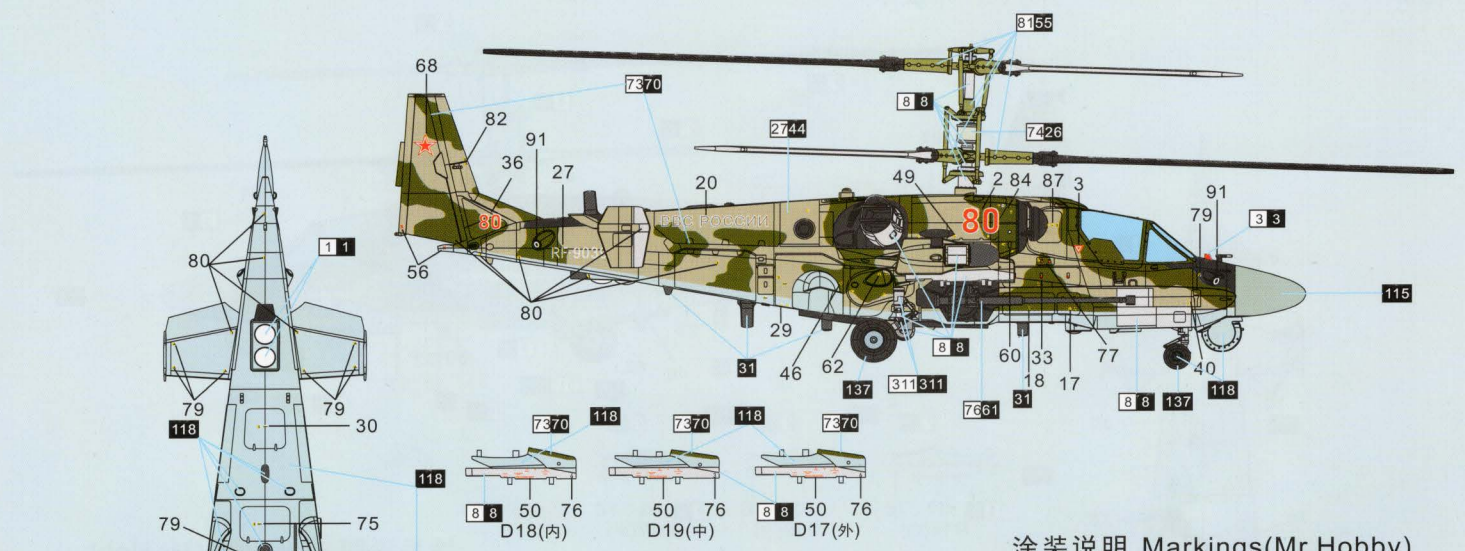

涂装说明 Markings(Mr.Hobby)

1 1	White 白色	8545	SAIL 帆布色	8155	KHAKI 卡奇色
2 2	Black 黑色	7661	BURNT IRON 烧蚀色	375	DEEP SEABLUE 深海蓝
3 3	Red 红色	7370	DARK GREEN 暗绿色	118	RLM78 浅蓝
8 8	Silver 银色	2744	TAN 浅棕黄	67 115	RLM65 浅蓝
31	DARK GRAY 深灰色	137	TIRE BLACK 胎黑	311 311	Fs36622 灰色
7426	DUCK EGG 鸭蛋绿	117	RLM76 浅蓝		

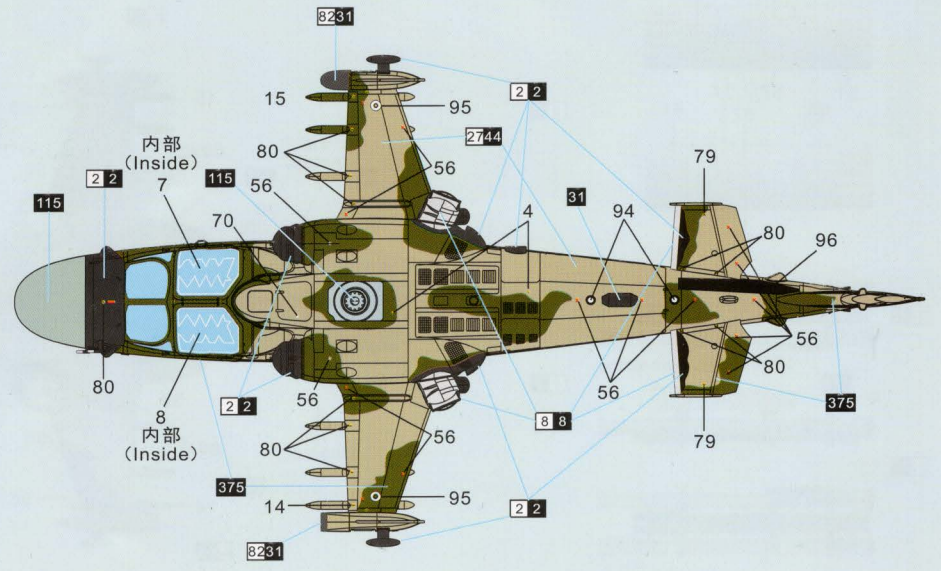
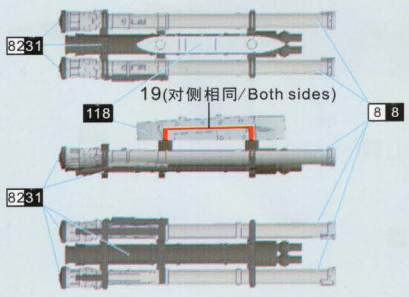
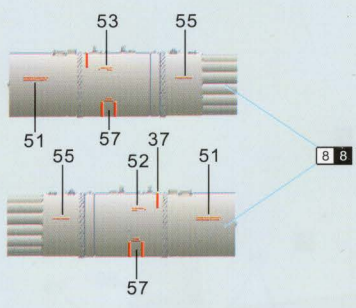
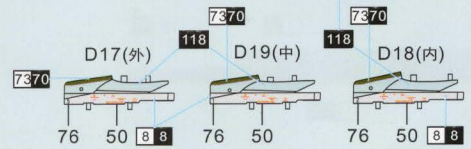
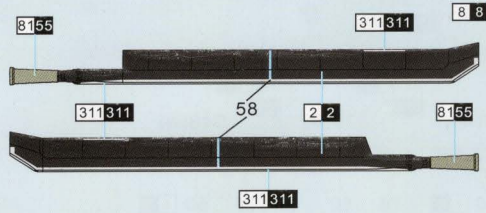
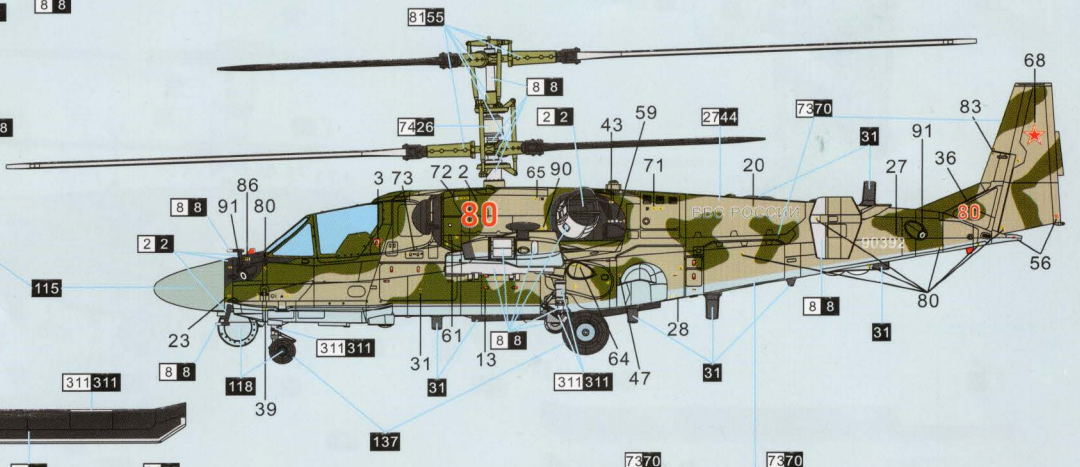
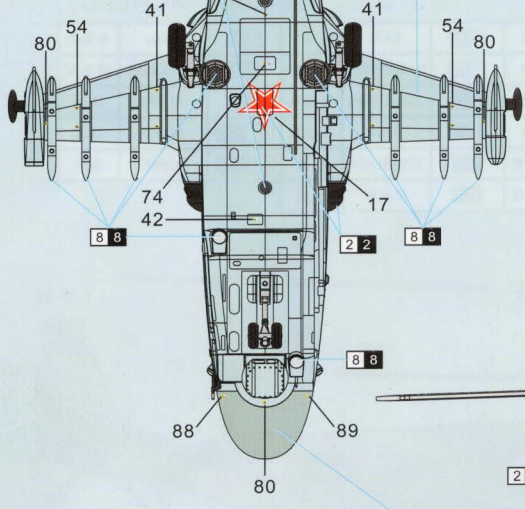

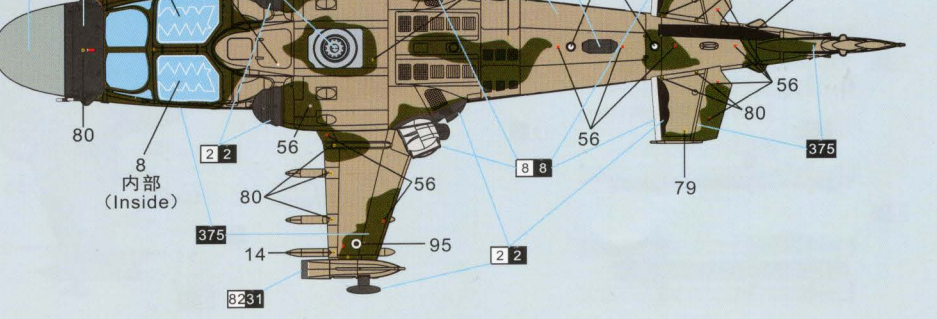
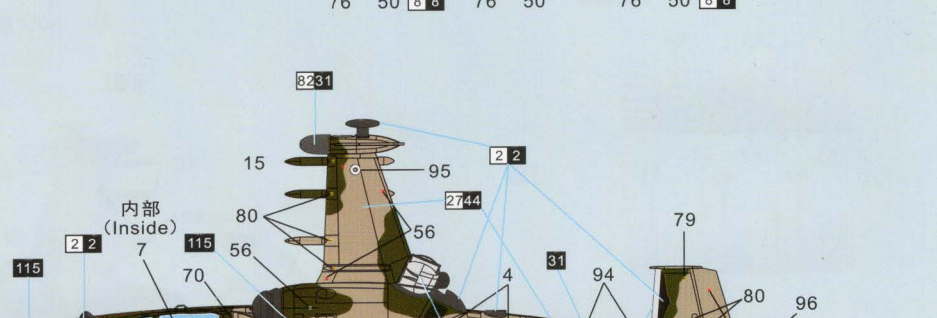
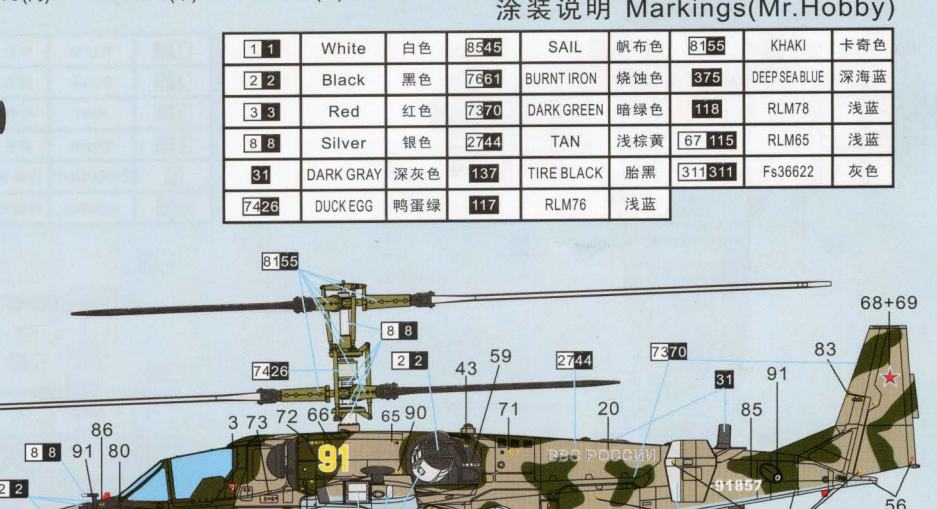
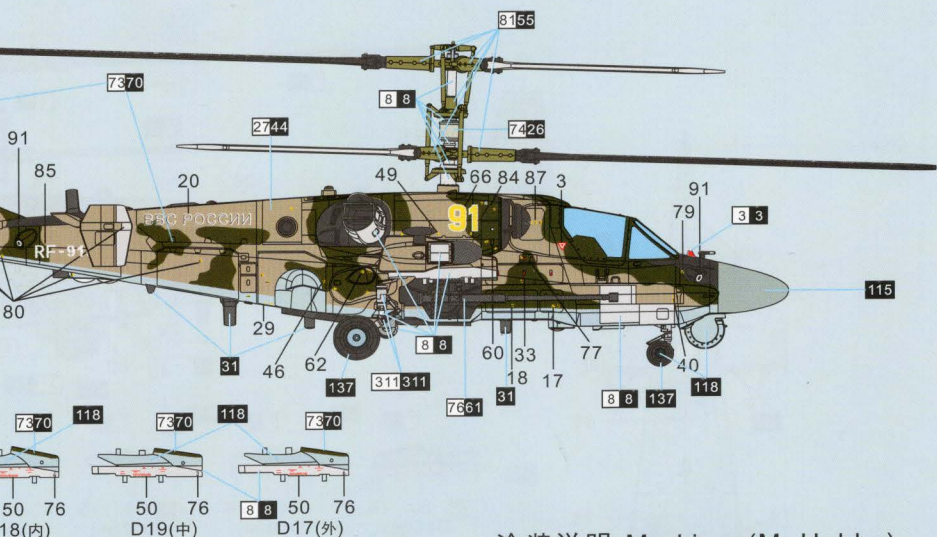
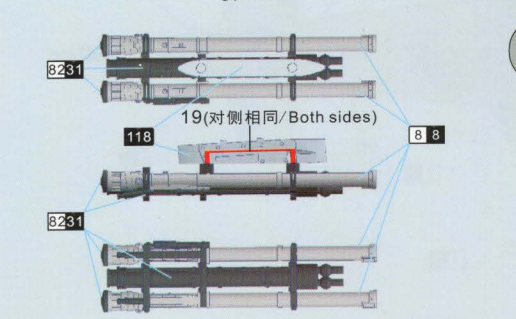
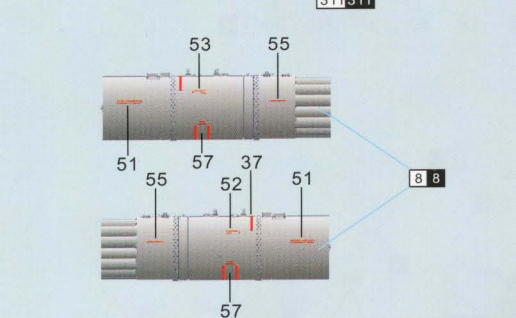
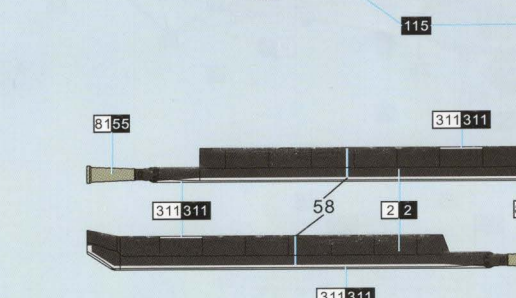
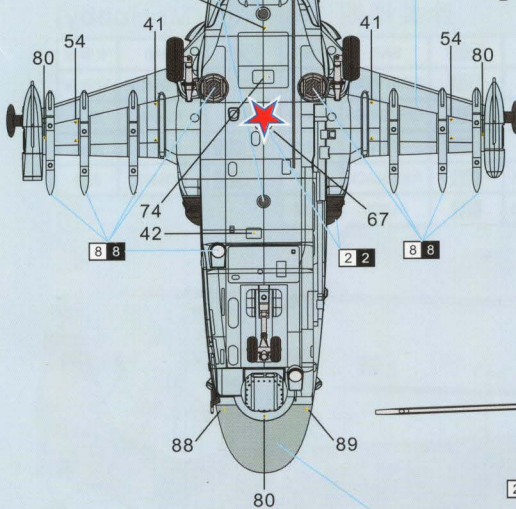
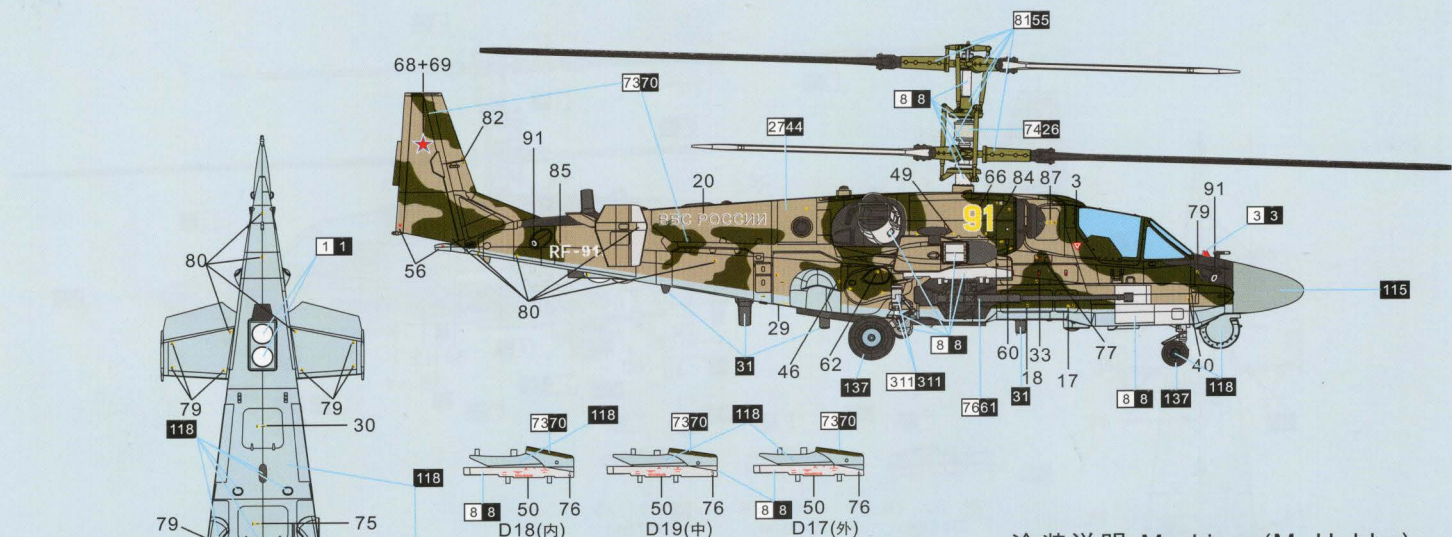

涂装说明 Markings(Mr.Hobby)

1 1	White 白色	8645	SAIL 帆布色	8155	KHAKI 卡奇色
2 2	Black 黑色	7661	BURNT IRON 烧蚀色	375	DEEP SEABLUE 深海蓝
3 3	Red 红色	7370	DARK GREEN 暗绿色	118	RLM78 浅蓝
8 8	Silver 银色	2744	TAN 浅棕黄	67 115	RLM65 浅蓝
31	DARK GRAY 深灰色	137	TIRE BLACK 胎黑	311 311	Fs36622 灰色
7426	DUCK EGG 鸭蛋绿	117	RLM76 浅蓝		

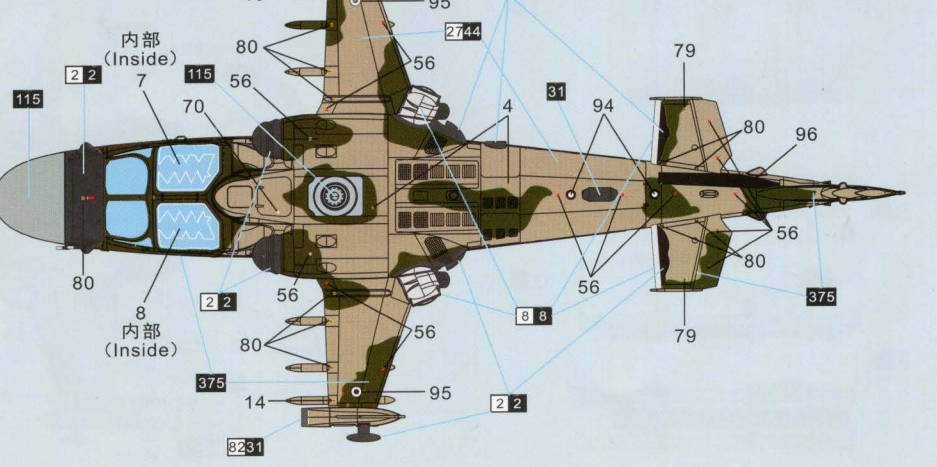
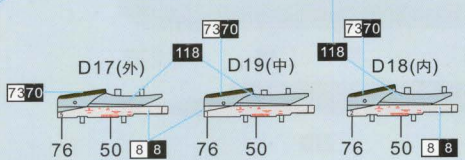
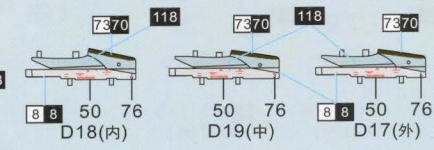

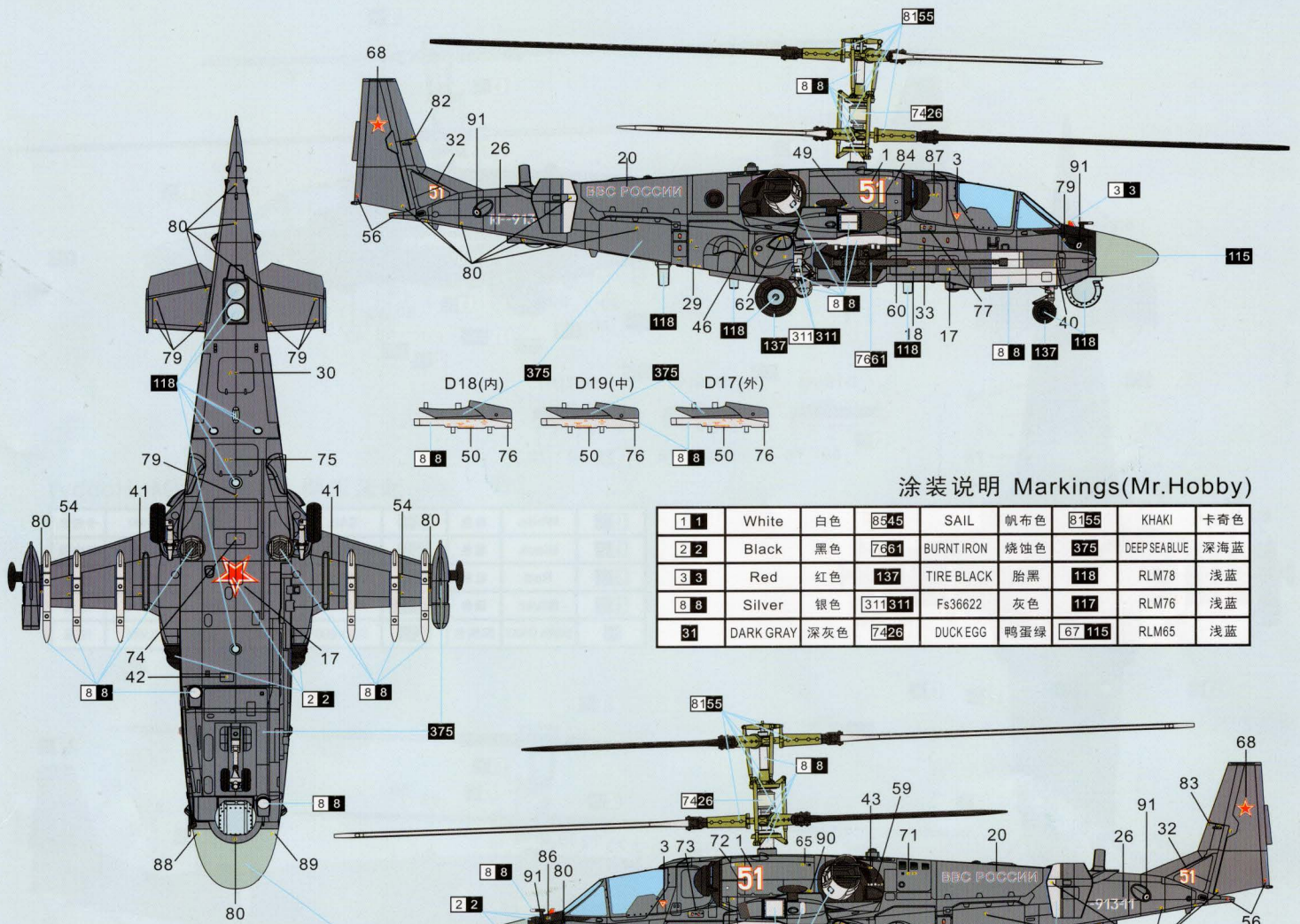

涂装说明 Markings(Mr.Hobby)

1 1	White 白色	8545	SAIL 帆布色	8155	KHAKI 卡奇色
2 2	Black 黑色	7661	BURNT IRON 烧蚀色	375	DEEP SEABLUE 深海蓝
3 3	Red 红色	137	TIRE BLACK 胎黑	118	RLM78 浅蓝
8 8	Silver 银色	311 311	Fs36622 灰色	117	RLM76 浅蓝
31	DARK GRAY 深灰色	7426	DUCK EGG 鸭蛋绿	67 115	RLM65 浅蓝

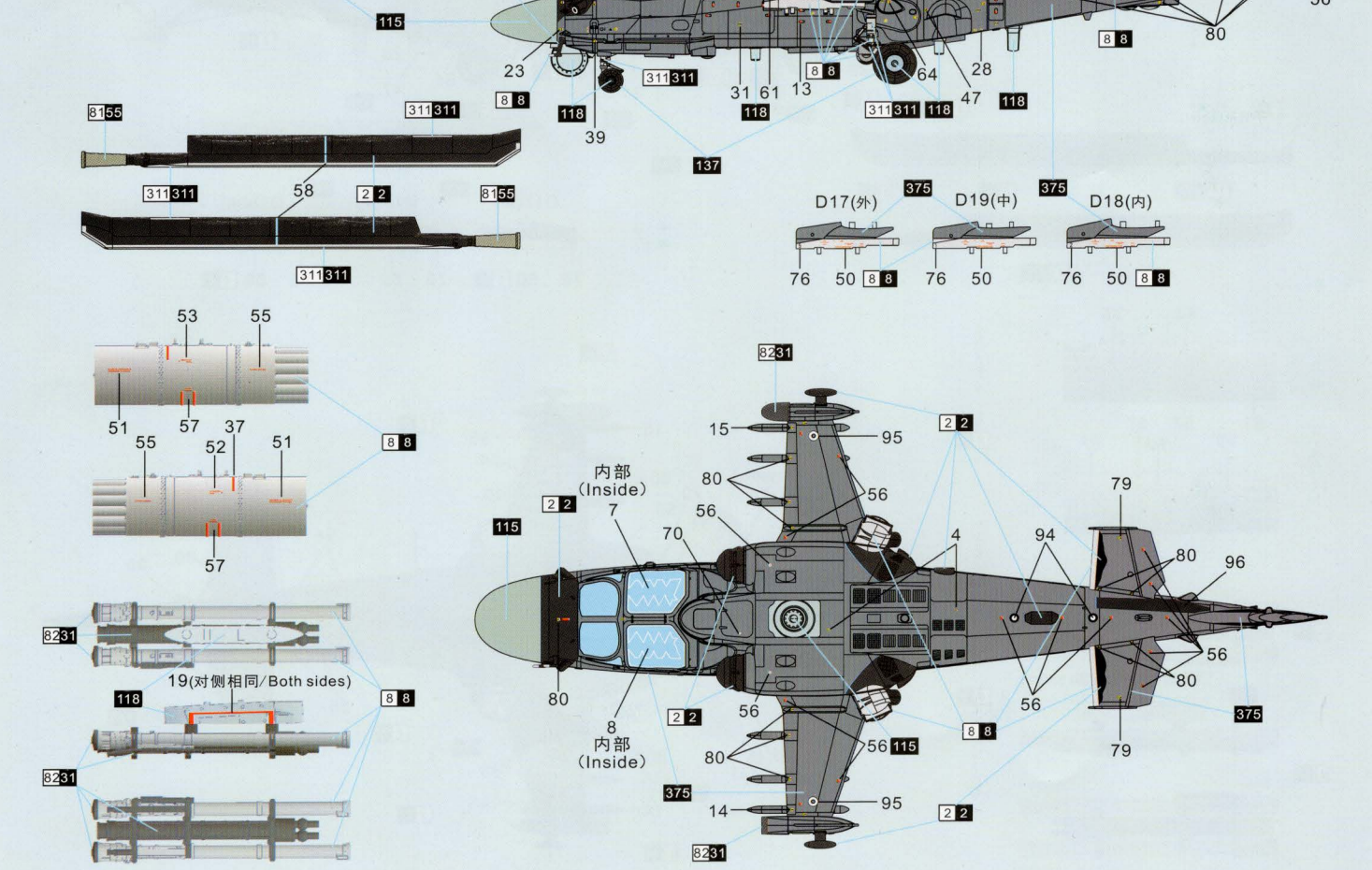

D17(外)	375	D19(中)	375	D18(内)	375
76 50 8 8		76 50		76 50 8 8	

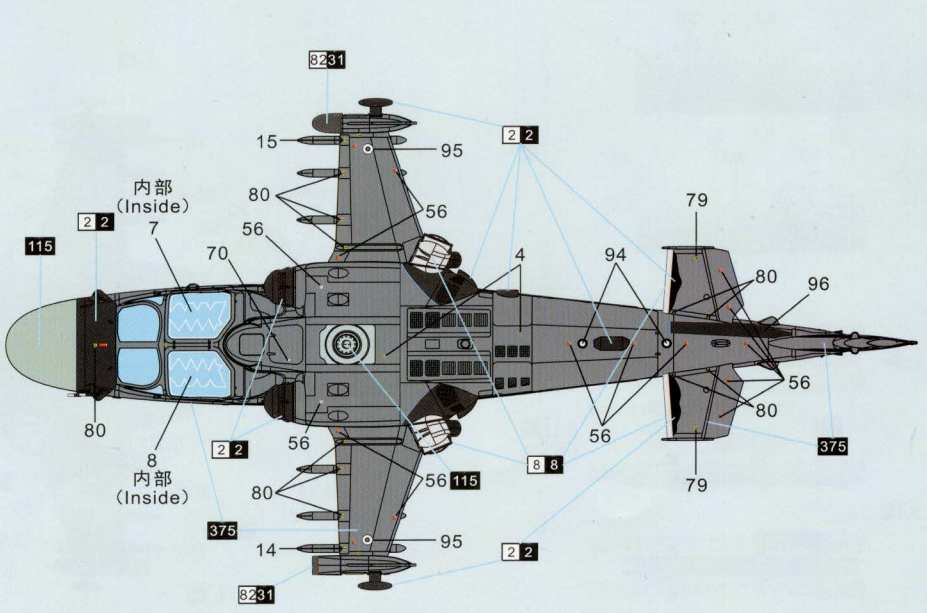
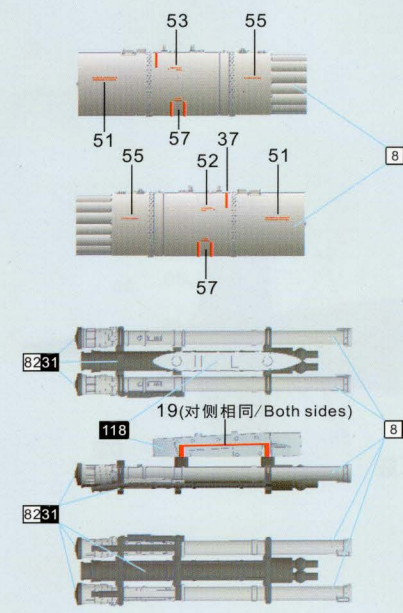

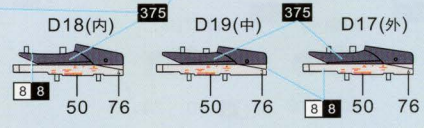
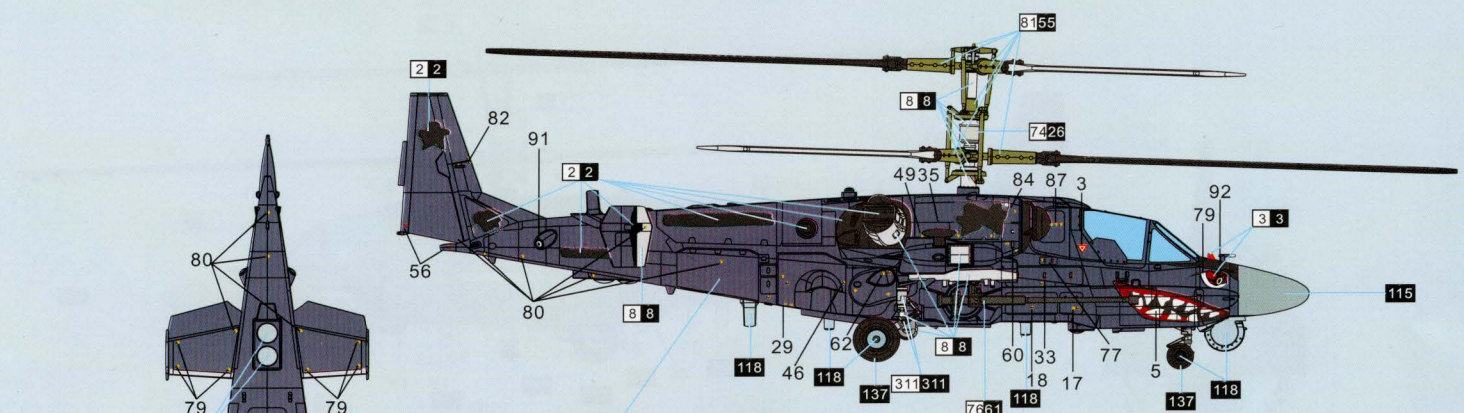

涂装说明 Markings(Mr.Hobby)

1 1	White 白色	8545	SAIL 帆布色	8155	KHAKI 卡奇色
2 2	Black 黑色	7661	BURNT IRON 烧蚀色	375	DEEP SEA BLUE 深海蓝
3 3	Red 红色	137	TIRE BLACK 胎黑	118	RLM78 浅蓝
8 8	Silver 银色	311 311	Fs36622 灰色	117	RLM76 浅蓝
31	DARK GRAY 深灰色	7426	DUCK EGG 鸭蛋绿	67 115	RLM65 浅蓝

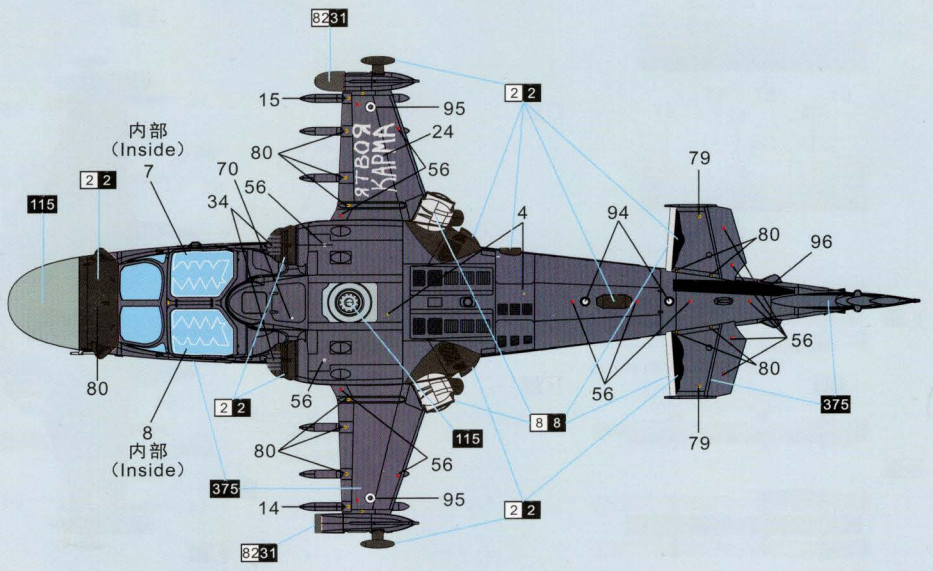
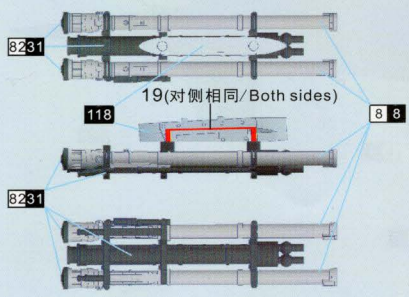
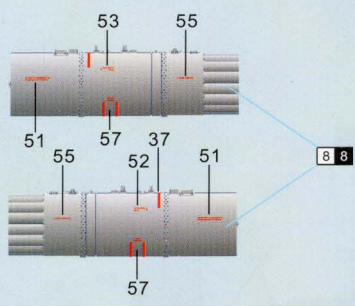
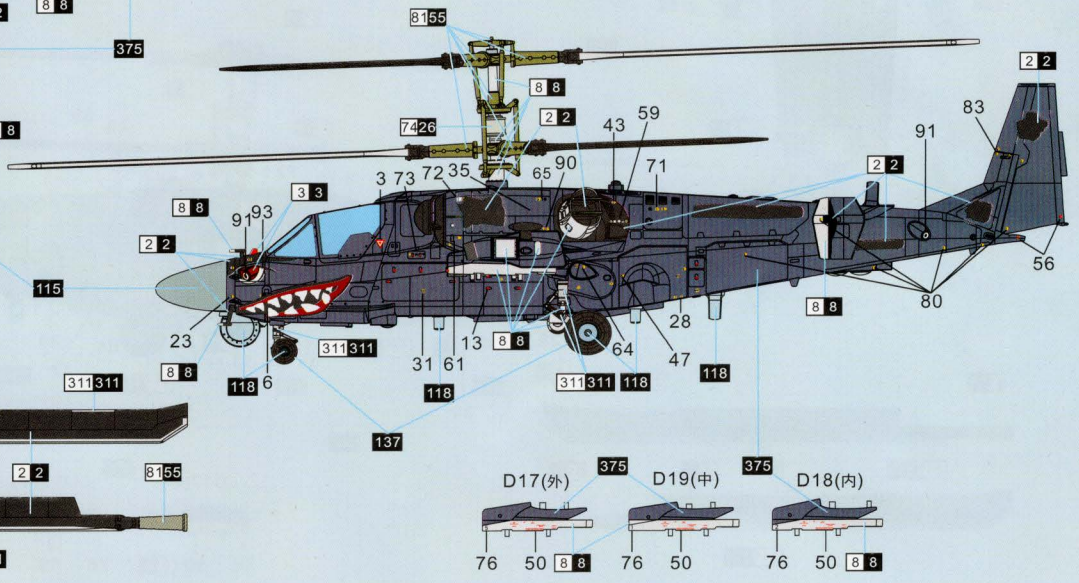
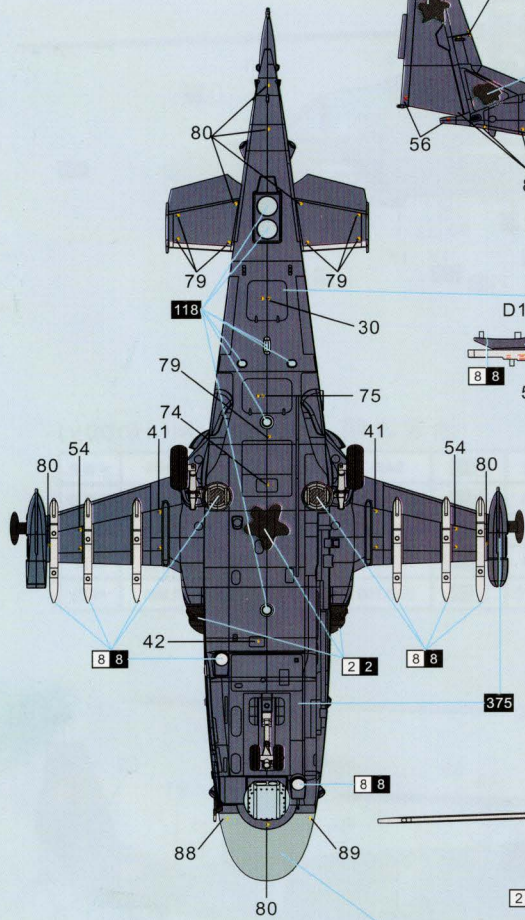

内部 (Inside)

内部 (Inside)