

**XTRADECAL**

X48212

## RAF Harrier GR.3s

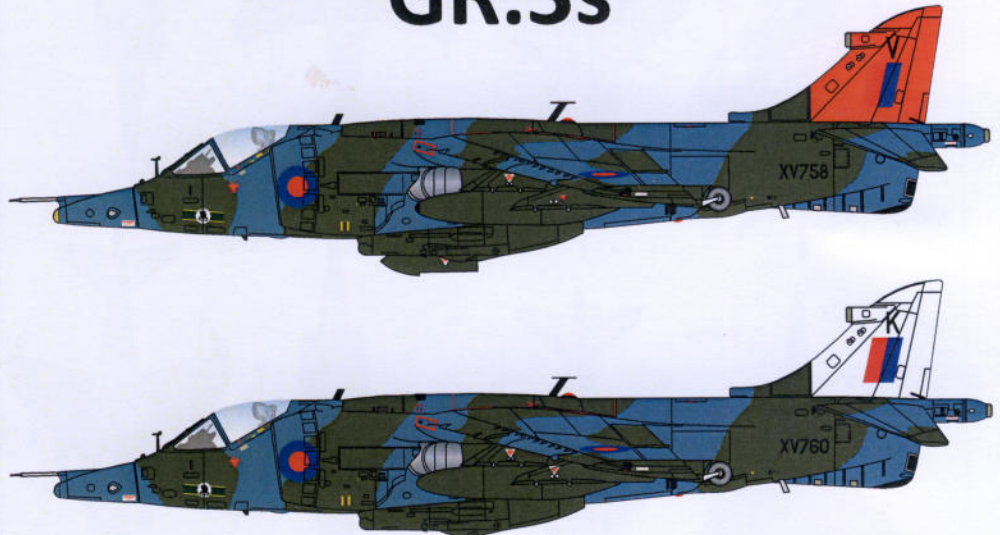

For the best results these decals should be applied to a gloss surface such as provided by either Xtracolor or Xtracrylix paints. Cut out the decal required and soak in warm water until the decal is released from the backing paper. Wet the area to be decaled with MICRO SET which will help to eliminate air trapped under the decal and position the decal.

After 5 or 10 minutes wet the decal with MICRO SOL which will soften the decal and ensure that it settles down over any surface detail. Allow the decal to dry for at least 12 hours. During this time some wrinkling of the decal may occur, this is normal. Do not touch the decal at this time.

Carefully check for small air bubbles and if there are any prick with a needle and apply a drop of MICRO SOL. After all air bubbles have been eliminated and the decals are dry wash the entire model with water to remove any excess decal adhesive.

When completely dry the whole model should be sprayed with a coat of Xtracolor or Xtracrylix with a coat of Flat, Satin or Gloss varnish depending on the finish required.

Store in a cool dry place, avoid sunlight, dampness or extremes of temperature and/or humidity.

**HANNANTS**

[www.hannants.co.uk](http://www.hannants.co.uk)

Harbour Road, Oulton Broad, Lowestoft, Suffolk, NR32 3LZ

Phone +44 1502 517444

Fax +44 1502 500521

XZ967  
ZD668  
XZ972  
XZ971  
XV760  
XV758  
XV787

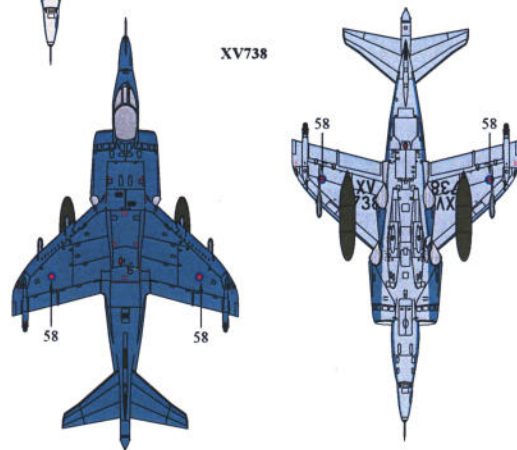
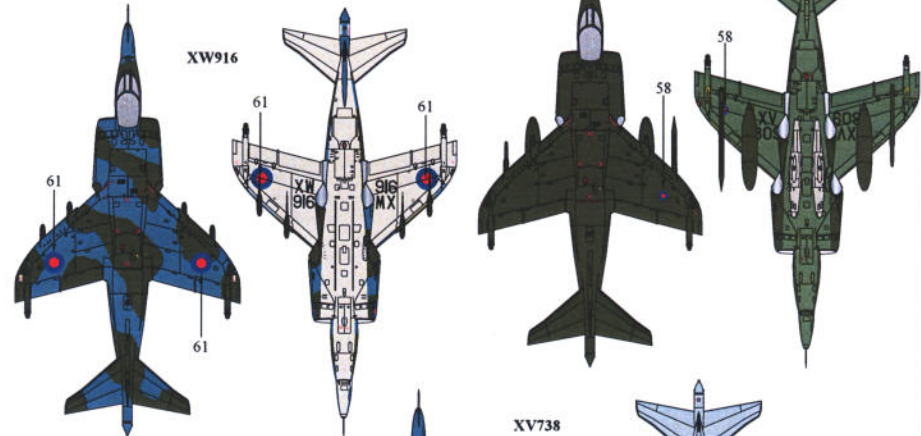
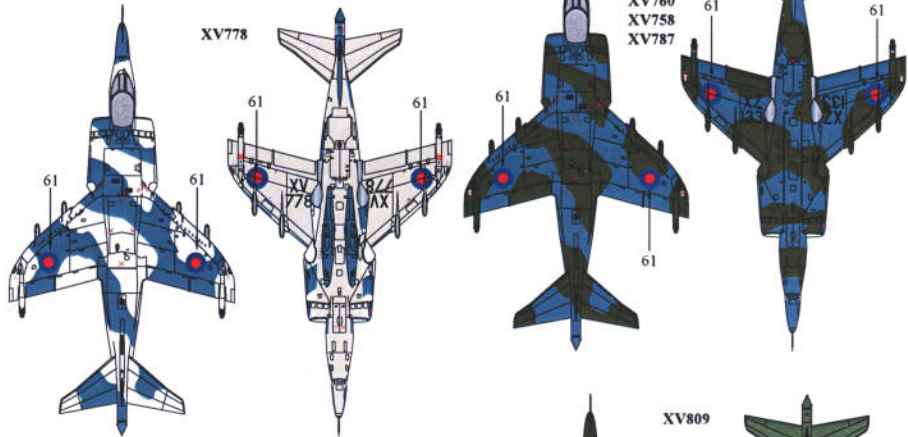

Hawker Siddeley Harrier GR.3,  
XV787, 'V' of  
1453 Flight, RAF,  
RAF Port Stanley,  
Falkland Islands,  
1983.

XV787 was finished in the then standard RAF wraparound  
camouflage of BS381C:241 Dark Green and BS381C:638 Dark Sea Grey.

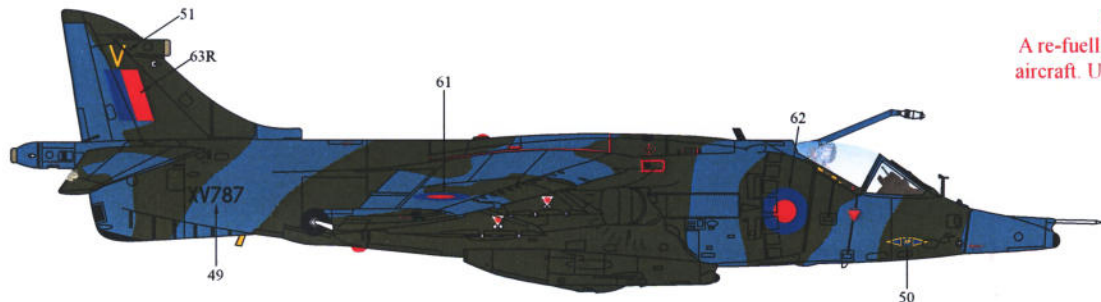
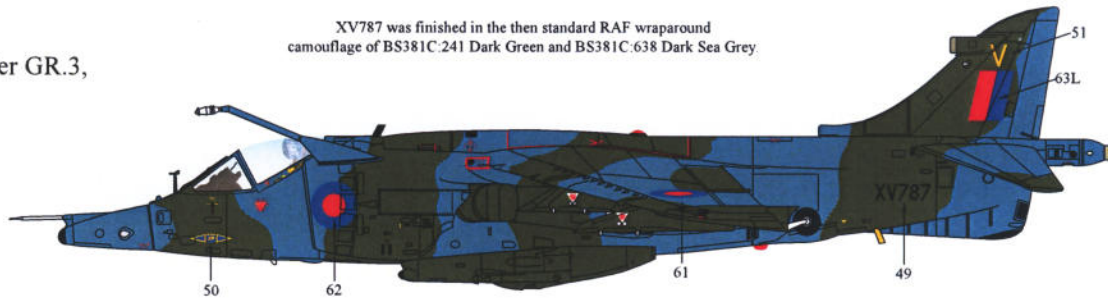

**Modellers Note:**  
A re-fuelling probe was fitted to this  
aircraft. Use the kit supplied stencils.

Outrigger Arms



Hawker Siddeley Harrier GR.3,  
XW916, 'CW' of  
IV Squadron, RAF,  
RAF Gutersloh,  
Germany  
1981.

XW916 was finished in the early RAF camouflage  
of BS381C:241 Dark Green and BS381C:638 Dark Sea Grey with  
BS381C:627 Light Aircraft Grey undersides.

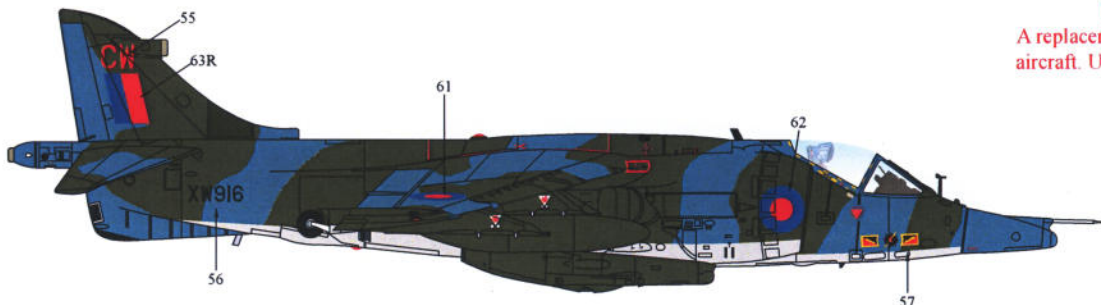
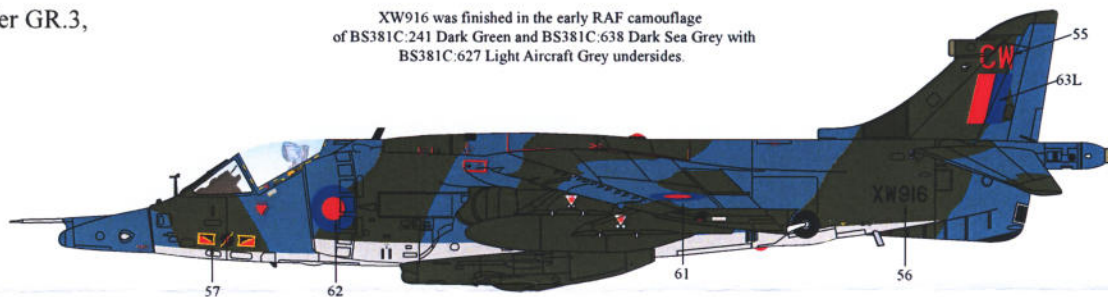

**Modellers Note:**  
A replacement nose was fitted to this  
aircraft. Use the kit supplied stencils.

Outrigger Arms

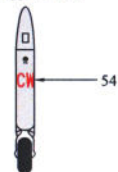

**Position of  
underwing serials**

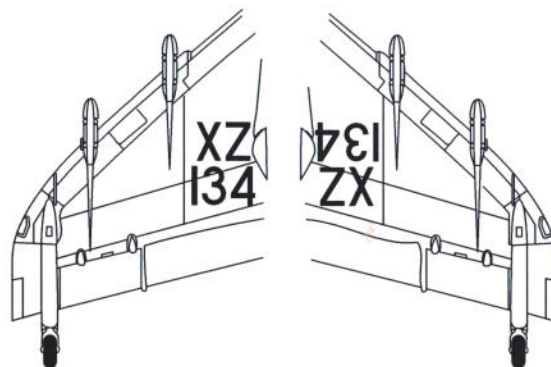

**Paints:**

The colours used on these aircraft can be found in the  
Xtracolor (prefix number with X) and Xtracrylix  
(prefix number with XA1) range of paints.

**Xtracolor Paints**

- X001 RAF Dark Green
- X004 RAF Dark Sea Grey
- X012 RAF Night Black
- X015 RAF Light Aircraft Grey
- X015 NATO Green
- X024 Lichen Green
- X501 Silver
- X504 Exhaust

**Xtracrylix Paints**

- XA1001 RAF Dark Green
- XA1004 RAF Dark Sea Grey
- XA1012 RAF Night Black
- XA1015 RAF Light Aircraft Grey
- XA1015 NATO Green
- XA1024 Lichen Green

Hawker Siddeley Harrier GR.3,  
 XV758, 'V' of 3 Squadron,  
 RAF, RAF Gutersloh,  
 West Germany,  
 April,  
 1989.

XV758 was finished in the then standard RAF wraparound camouflage of BS381C:241 Dark Green and BS381C:638 Dark Sea Grey with a Red-Orange temporary painted vertical fin.

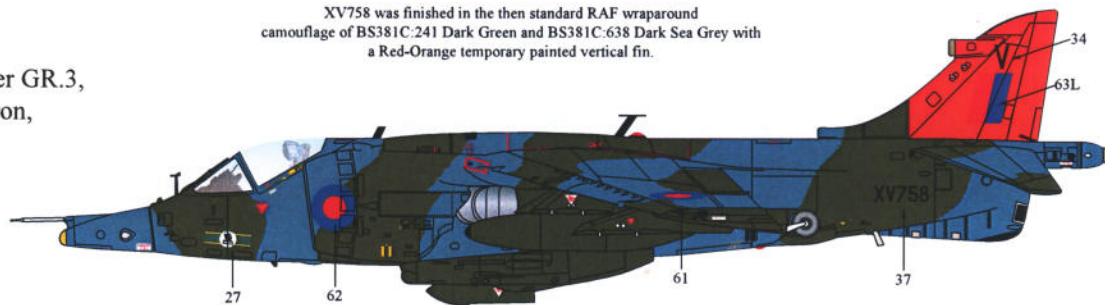

**Modellers Note:**  
 The 'T Shaped' antenna on the spine will need to be scratchbuilt. Use the kit supplied stencils.

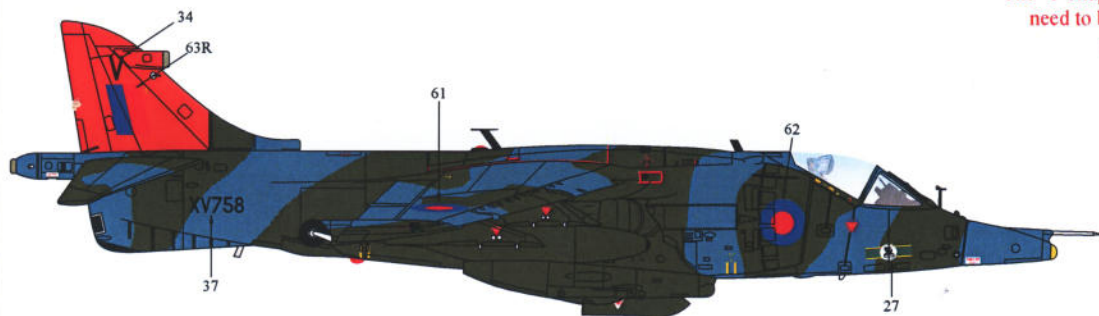

**Outrigger Arms**



Hawker Siddeley Harrier GR.3,  
 XV778, '16' of  
 1(F) Squadron, RAF,  
 during Exercise 'Cold Winter'  
 deployed to Tromso,  
 Norway,  
 1979.

XV778 was finished in the early RAF camouflage of BS381C:241 Dark Green and BS381C:638 Dark Sea Grey with BS381C:627 Light Aircraft Grey undersides. For 'Exercise Cold Winter' the BS381C:241 Dark Green areas were overpainted with temporary White distemper paint.

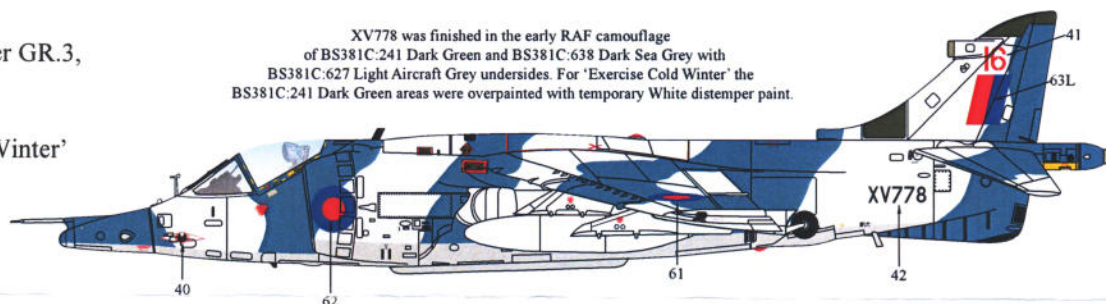

**Modellers Note:**  
 No LMTS was fitted to the nose.  
 Use the kit supplied stencils.

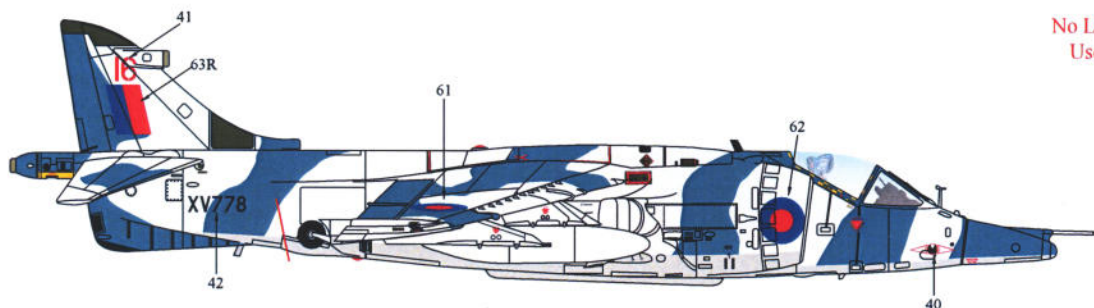

**Outrigger Arms**

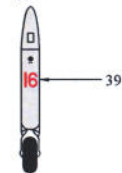

Hawker Siddeley Harrier GR.3,  
 XV809, 'AF' of  
 3 Squadron, RAF,  
 during Exercise  
 'Match-Coat' 1984.

XV809 was finished in an experimental finish of BS381C:285 NATO Green upper surfaces with 12-B-25 Lichen Green undersides. Aden gun packs were BS381C:627 Light Aircraft Grey.



**Outrigger Arms**

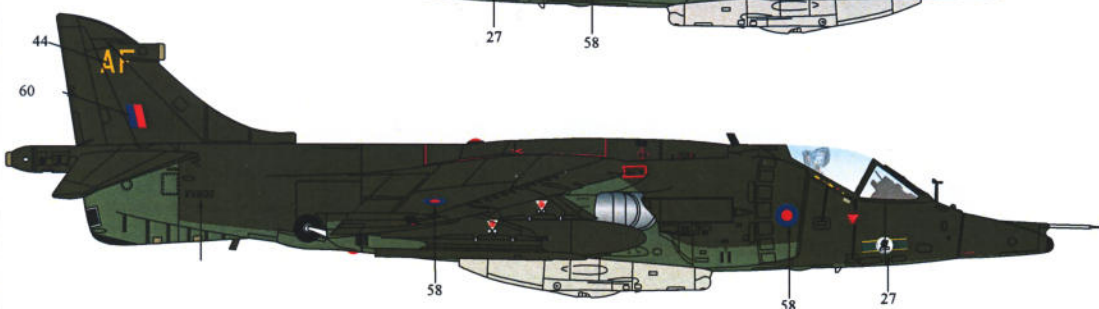

Hawker Siddeley Harrier GR.3,  
 XZ971, 'G', 'Hod Carrier' of 1473  
 Flight, RAF,  
 RAF Belize,  
 Belize,  
 1993.

XZ971 was finished in the then standard RAF wraparound  
 camouflage of BS381C:241 Dark Green and BS381C:638 Dark Sea Grey.  
 BS381C:637 Medium Sea Grey wing mounted fuel tanks.

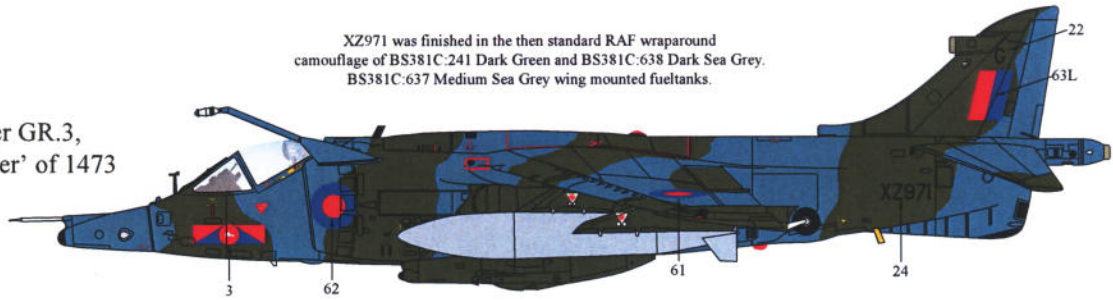

**Modellers Note:**  
 A re-fuelling probe was fitted to this  
 aircraft. Use the kit supplied stencils.

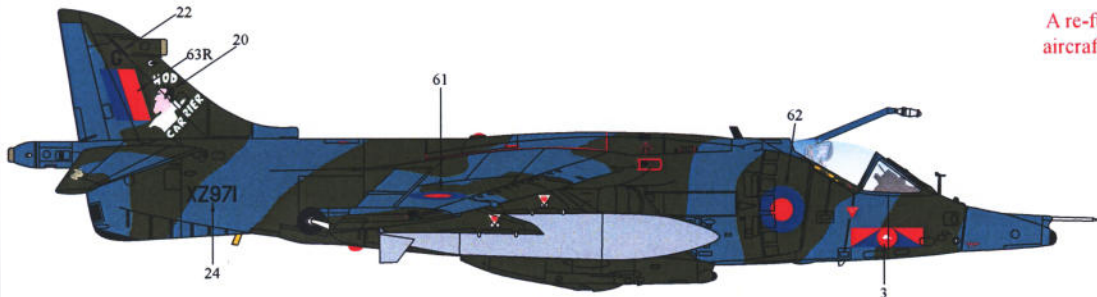

**Outrigger Arms**

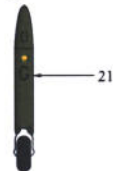

Hawker Siddeley Harrier GR.3,  
 XV760, 'K' of 3 Squadron,  
 RAF, RAF Gutersloh,  
 West Germany,  
 April  
 1989.

XV760 was finished in the then standard RAF wraparound  
 camouflage of BS381C:241 Dark Green and BS381C:638 Dark Sea Grey with  
 a White temporary painted vertical fin.

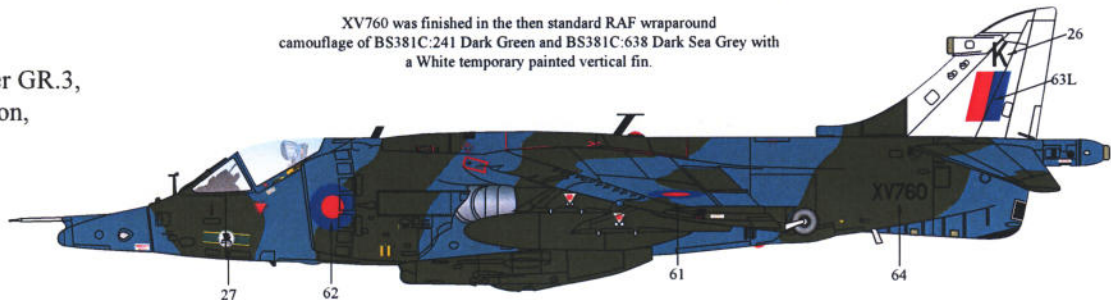

**Modellers Note:**  
 The 'T Shaped' antenna on the spine will  
 need to be scratchbuilt. Use the kit  
 supplied stencils.

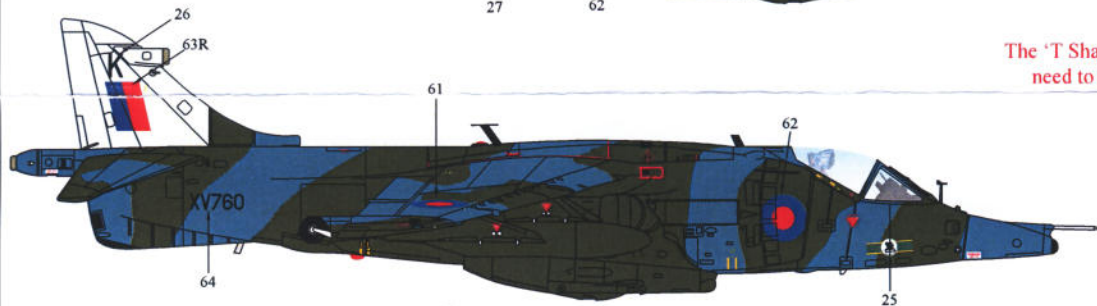

**Outrigger Arms**

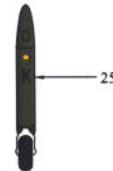

Hawker Siddeley Harrier GR.3,  
 XV738, 'B'  
 of No.IV (AC) Squadron,  
 during 'Operation Matchcoat',  
 RAF Gutersloh,  
 West Germany,  
 1984.

XV738 was finished in a experimental finish of BS381C:638 Dark Sea Grey uppersurfaces with  
 BS381C:637 Medium Sea Grey undersides. Dielectric panels were BS381C:241 Dark Green.

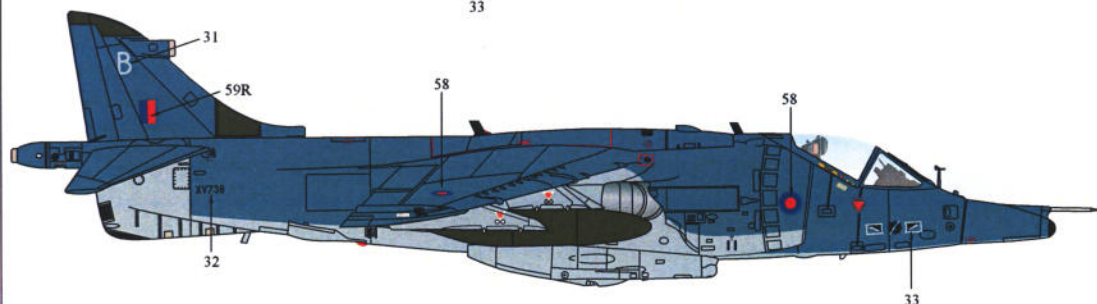
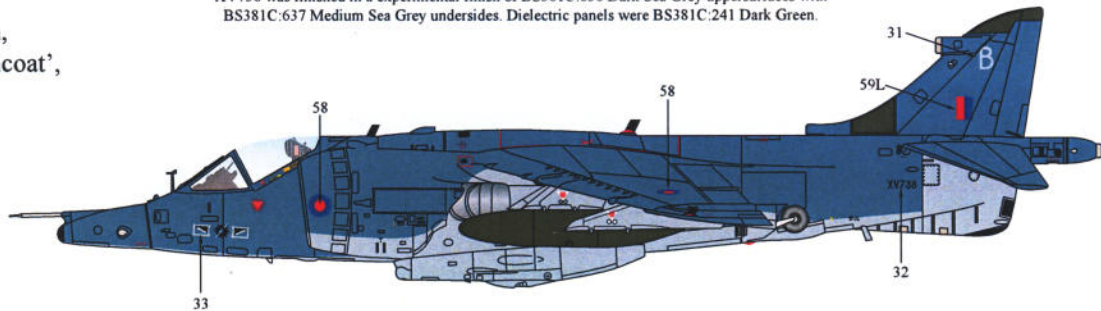

Hawker Siddeley Harrier GR.3,  
 XZ967, 'D', 'Donatello' of  
 1473 Flight, RAF,  
 RAF Belize,  
 Belize,  
 1993.

XZ967 was finished in the then standard RAF wraparound  
 camouflage of BS381C:241 Dark Green and BS381C:638 Dark Sea Grey.

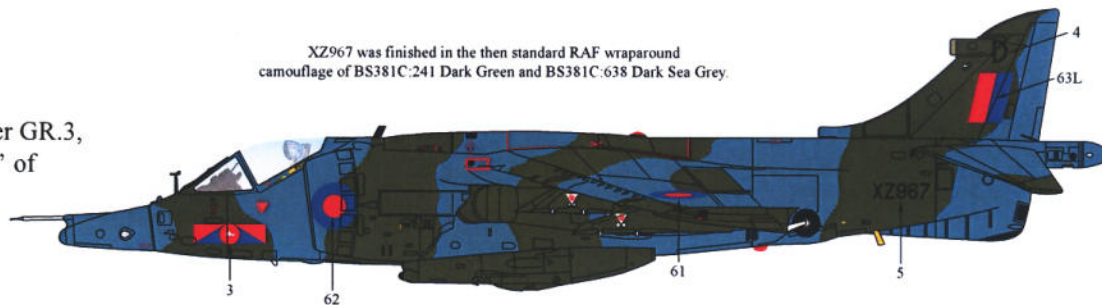

**Modellers Note:**  
 No LMTS was fitted to the nose.  
 Use the kit supplied stencils.

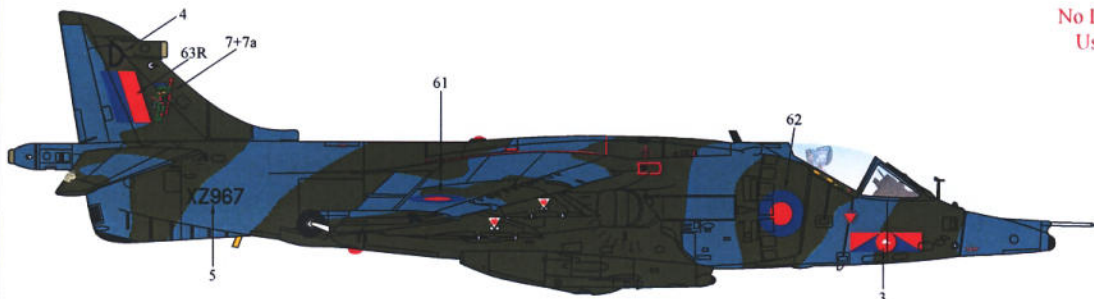

**Outrigger Arms**



Hawker Siddeley Harrier GR.3,  
 ZD668, '3E' of 20(R) Squadron/233 OCU,  
 RAF, RAF Laarbruch,  
 West Germany,  
 30 March 1993.

ZD668 was finished in the then standard RAF wraparound  
 camouflage of BS381C:241 Dark Green and BS381C:638 Dark Sea Grey.

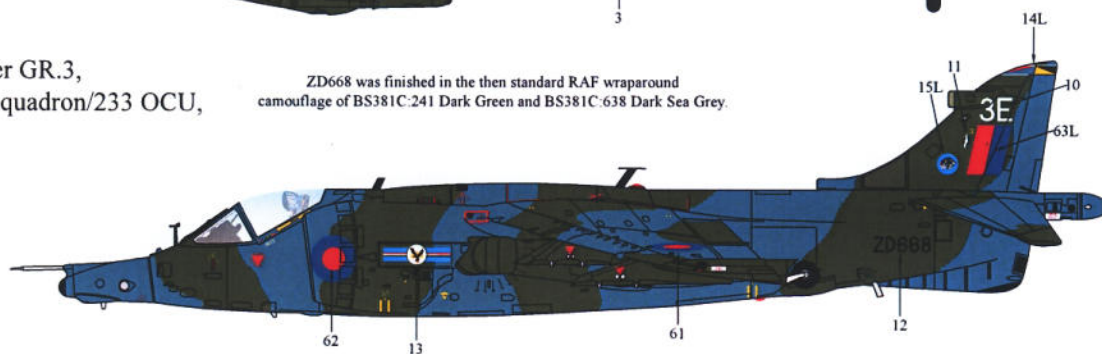

**Modellers Note:**  
 The 'T Shaped' antenna on the spine will  
 need to be scratchbuilt. Use the kit  
 supplied stencils.

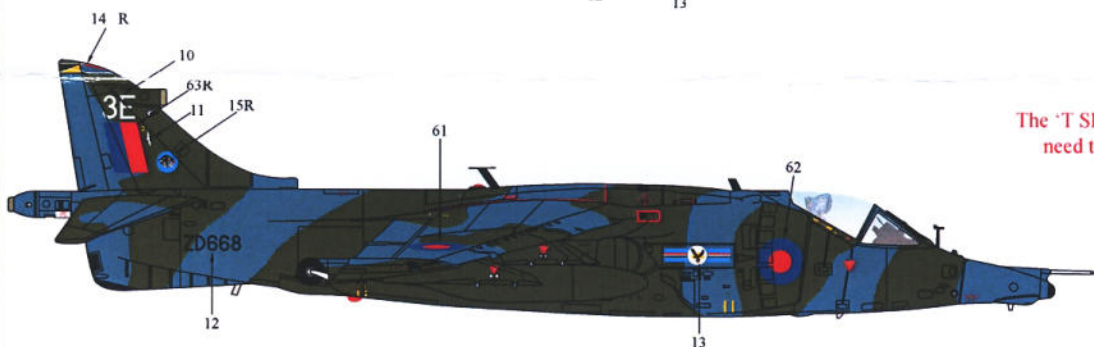

Hawker Siddeley Harrier GR.3,  
 XZ972, 'Red 33' flown by Flight Lieutenant  
 Jeff Glover of 1(F) Squadron, RAF  
 aboard HMS Hermes, during  
 'Operation Corporate,  
 South Atlantic,  
 21 May 1982.

XZ972 was finished in the then standard RAF wraparound  
 camouflage of BS381C:241 Dark Green and BS381C:638 Dark Sea Grey.

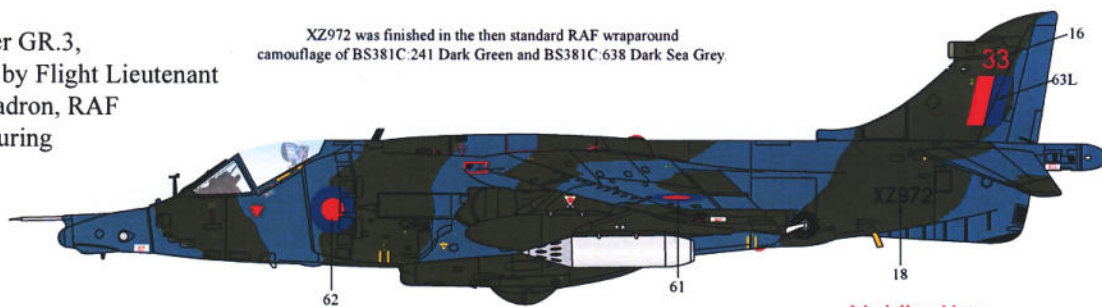

**Modellers Note:**  
 The Blue Eric ECM blade fitted onto the  
 starboard Aden cannonpack will need to  
 be scratchbuilt as will the LMTS fit on  
 the nose. Use the kit supplied stencils.

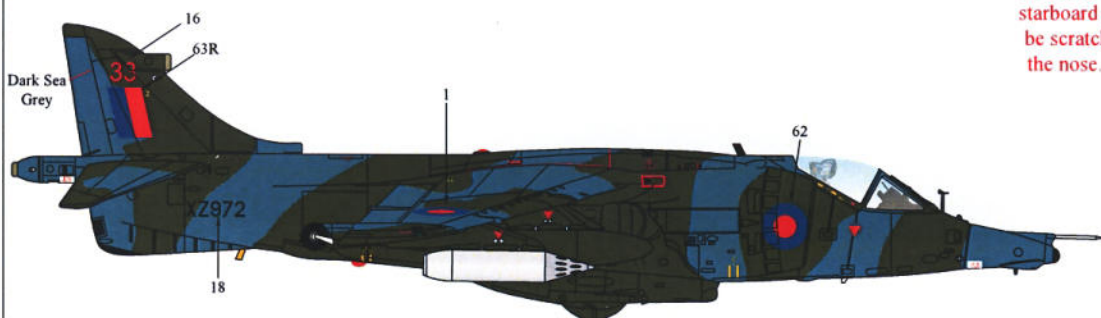

**Outrigger Arms**

