

Item No.:

科学忍者隊ガッチャマン ゴッドフェニックス

Tatsunoko
PRODUCTION

© Tatsunoko Production

- > 本製品は対象年齢14歳以上の組立キットです。組立前に説明書を読み、必要な工具類は別途お買い求めください。
- > 尖った部品や小さな部品が含まれています。取扱にご注意のうえ、小さなお子様の手の届かない所に保管してください。
- > 高温多湿および直射日光が当たることでの劣化は避け、品質の低下をまねきますので、お控えください。
- > パッケージイラストは完成後の製品と異なる表現がてさいです。



科学忍者隊

ガッチャマン

GOD PHOENIX

ACADEMY

HOBBY MODEL KITS

1

* Assemble in numerical order starting with ①
①から番号順に組み立ててください

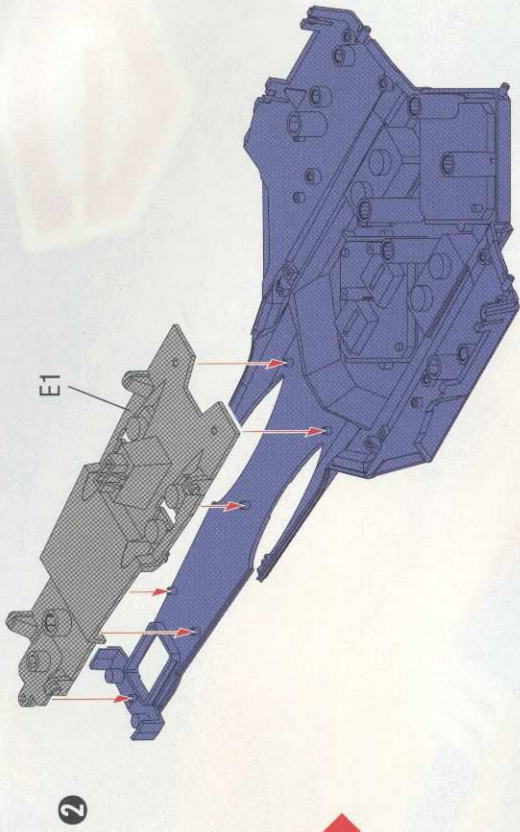
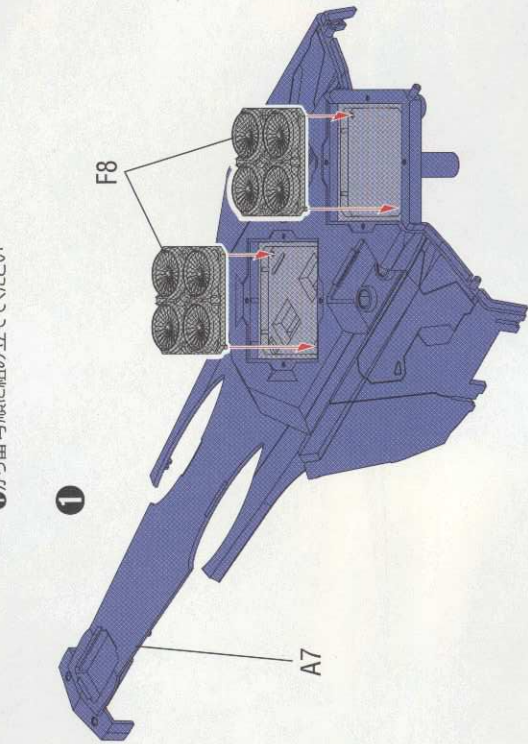

3

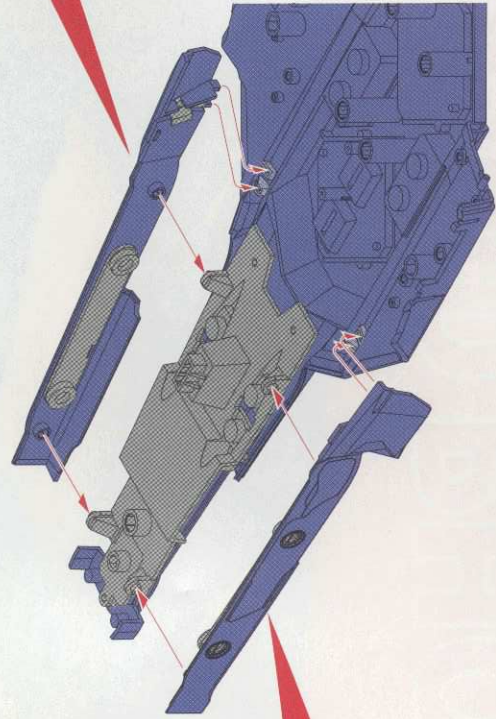
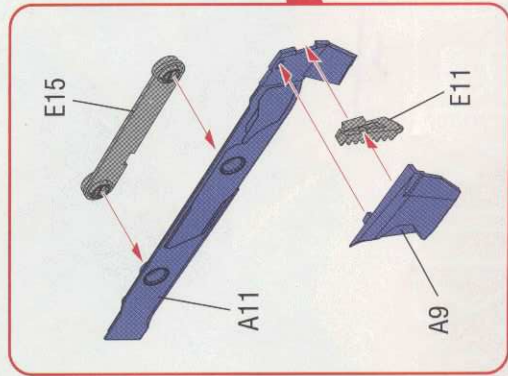

4

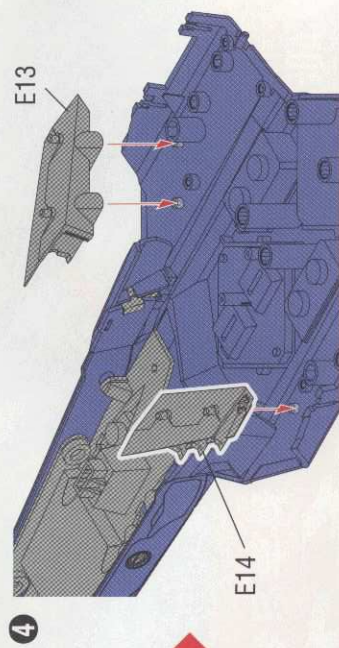
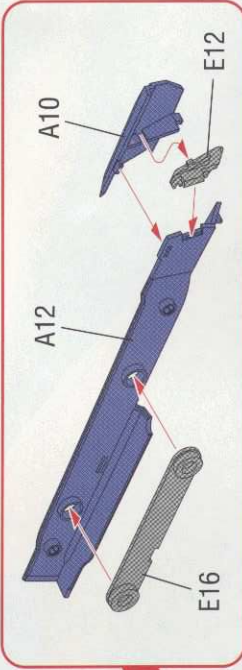

2

1

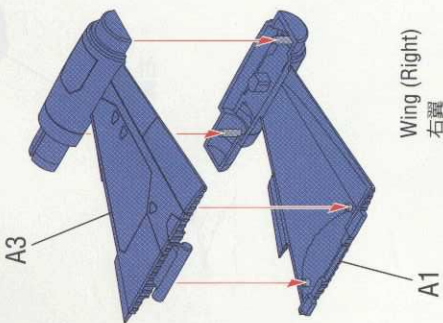

2

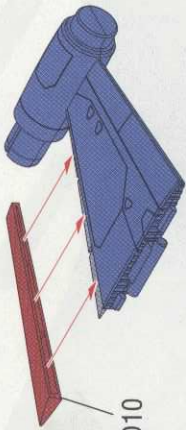

3

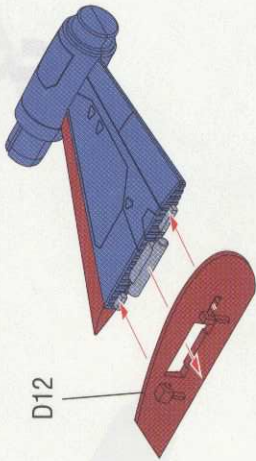

4

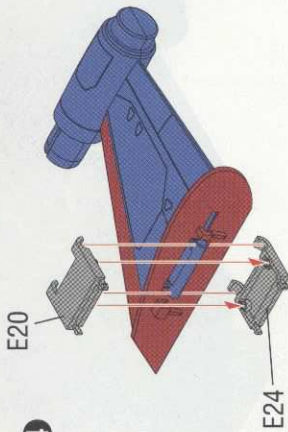

5

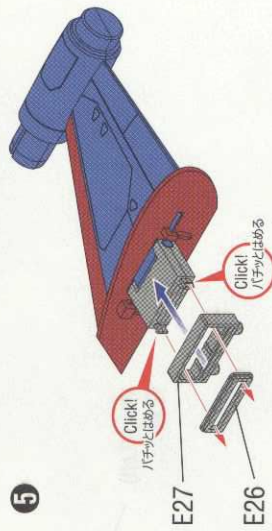

1

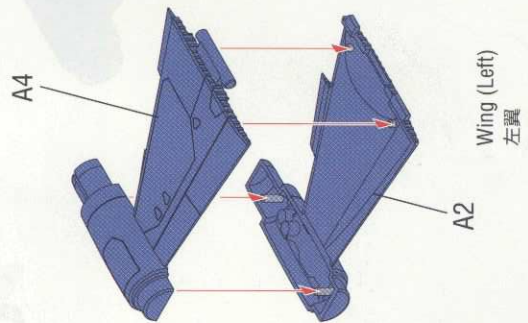

2

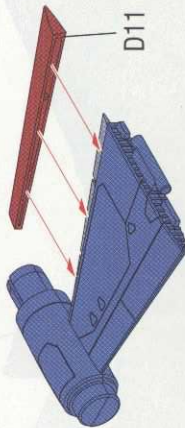

3

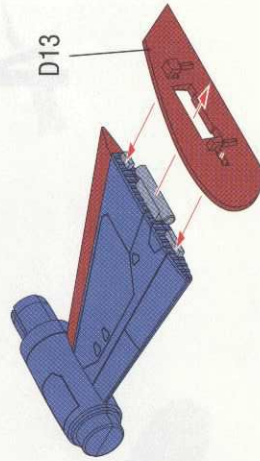

4

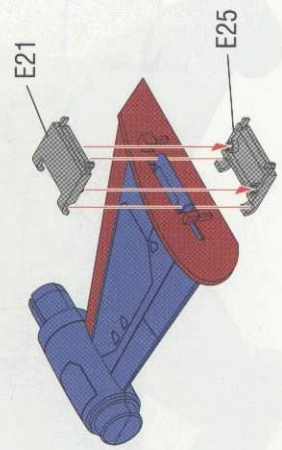

5

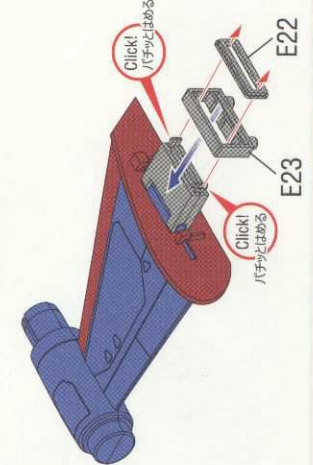

3

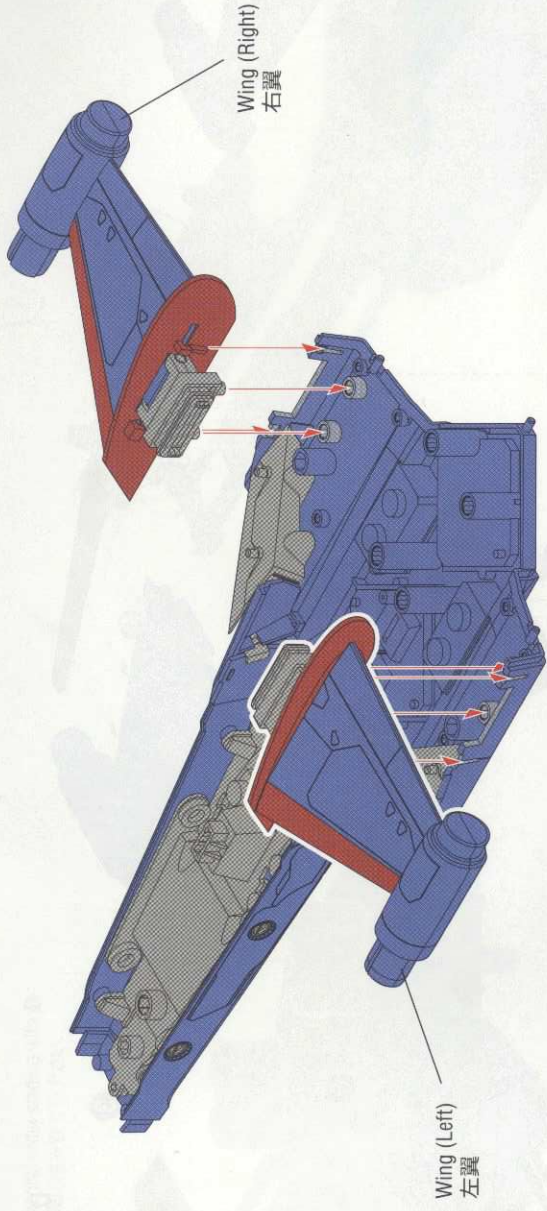

4

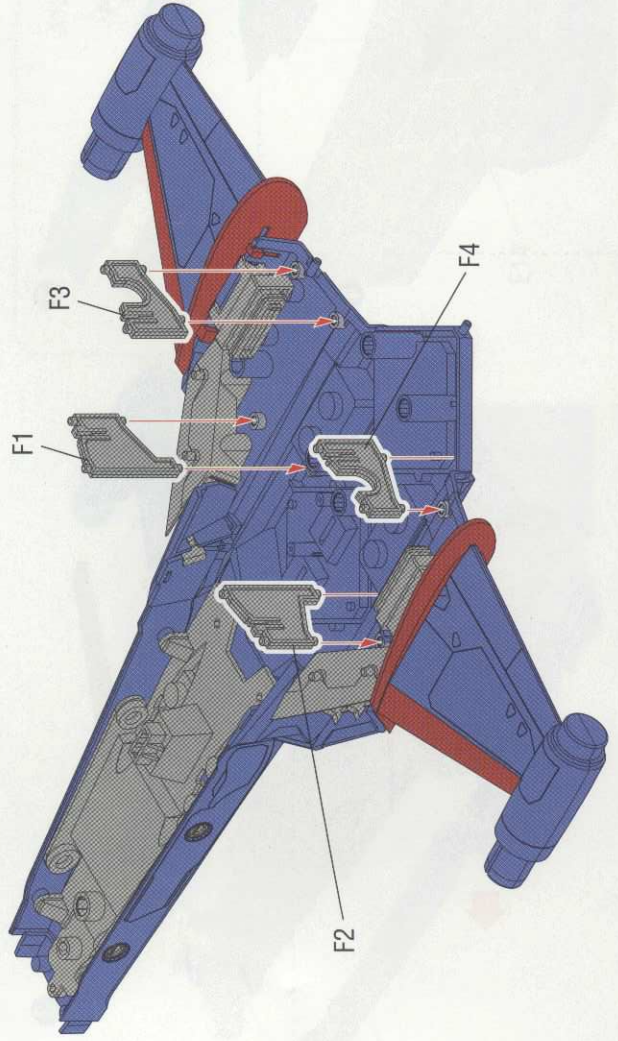

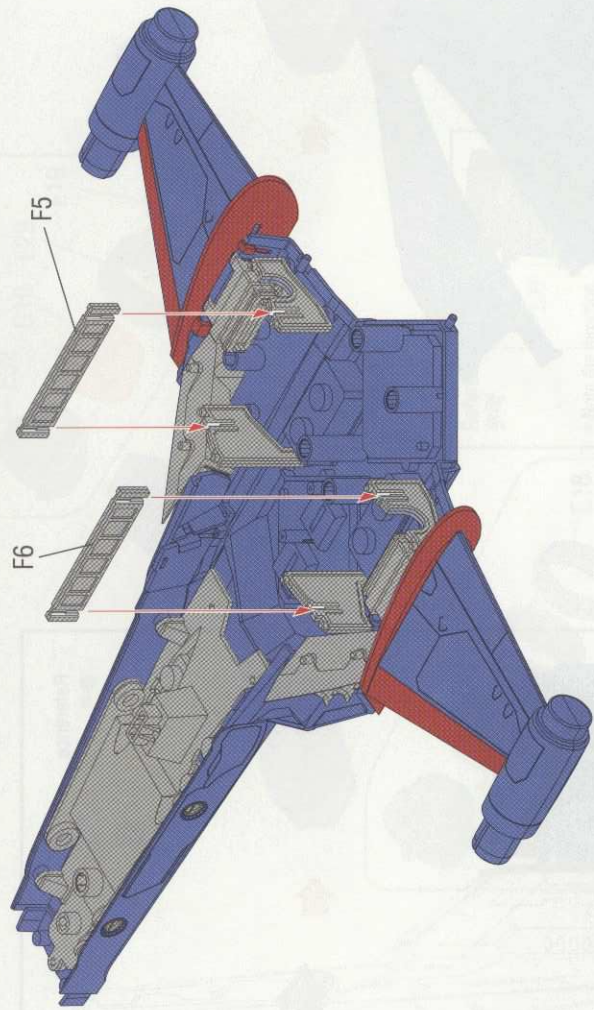

5

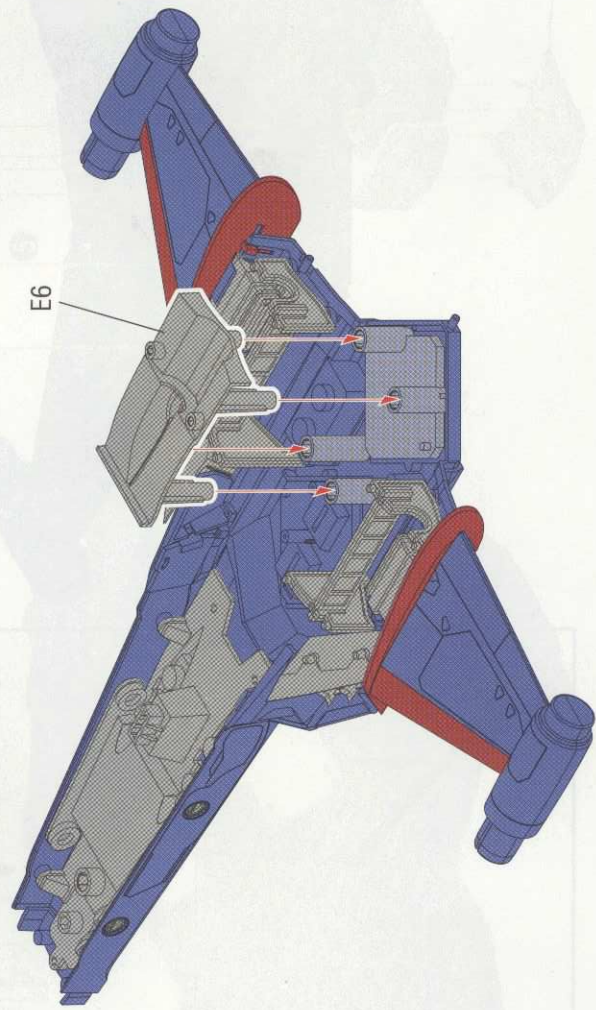

6

7

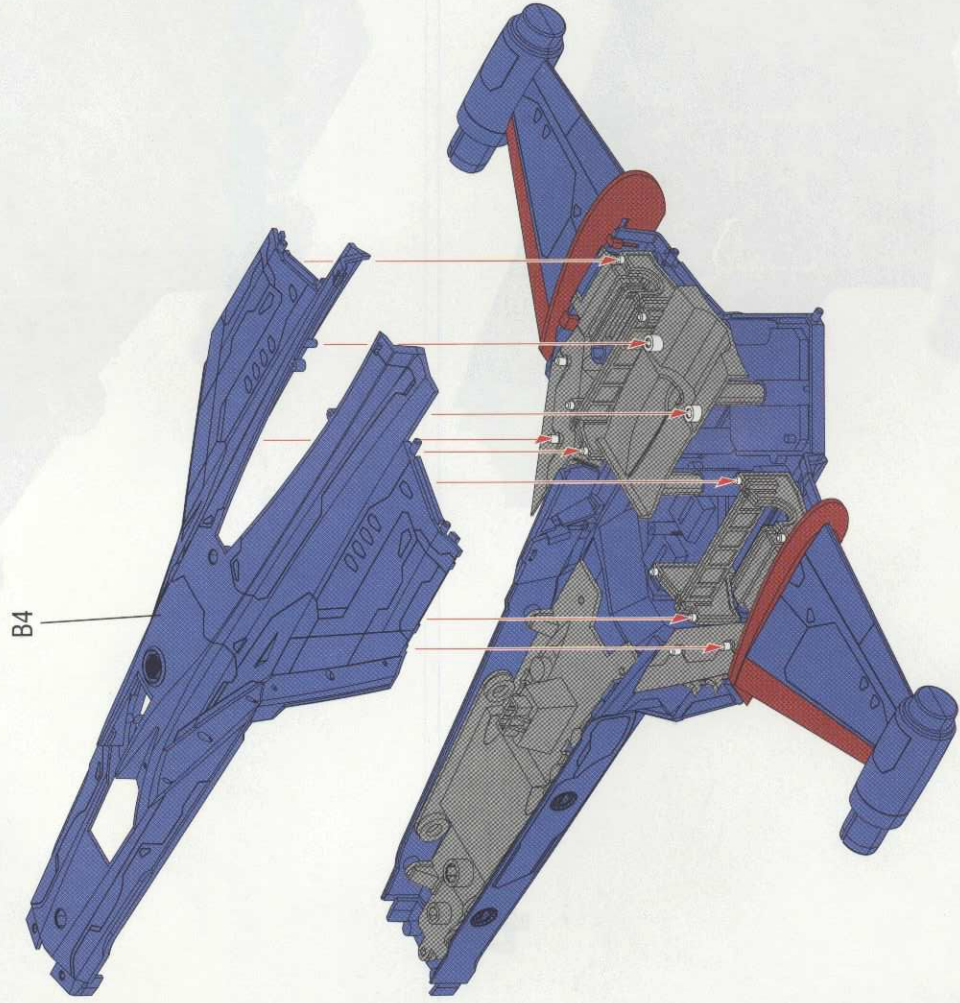

Reference
参考

OPTION
選択式

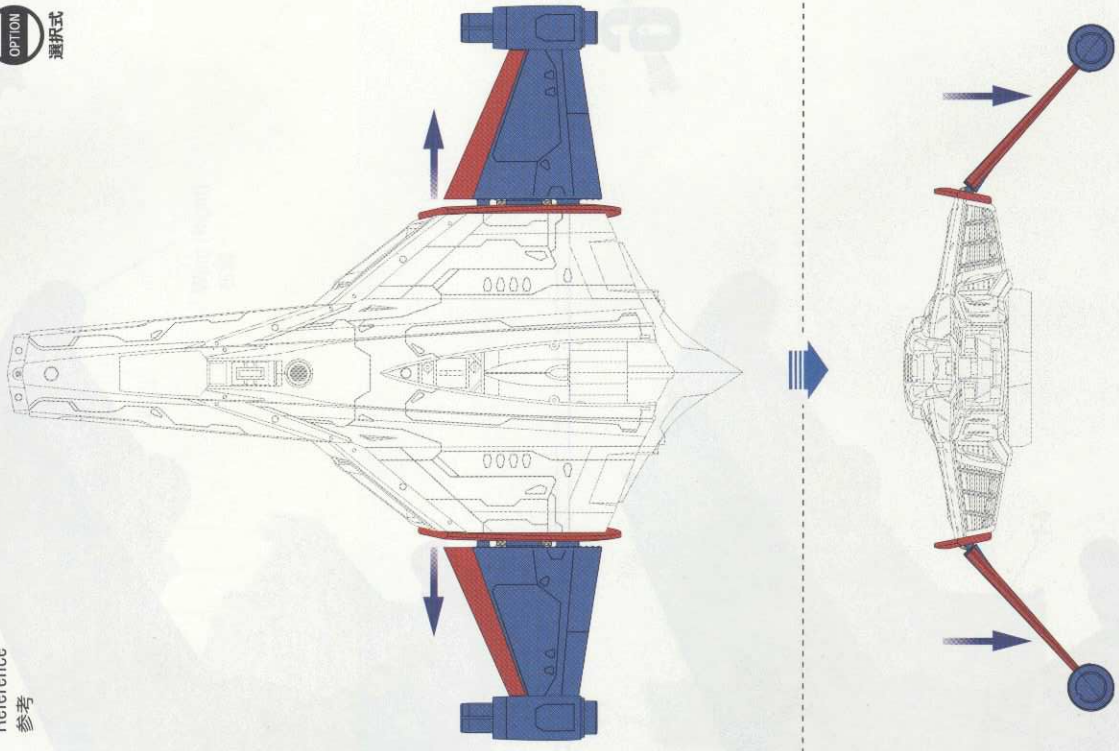

8

1

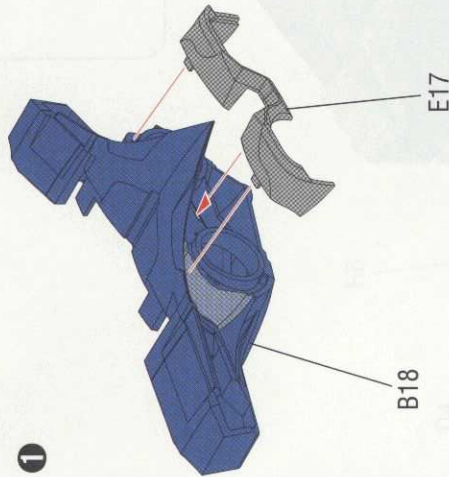

2

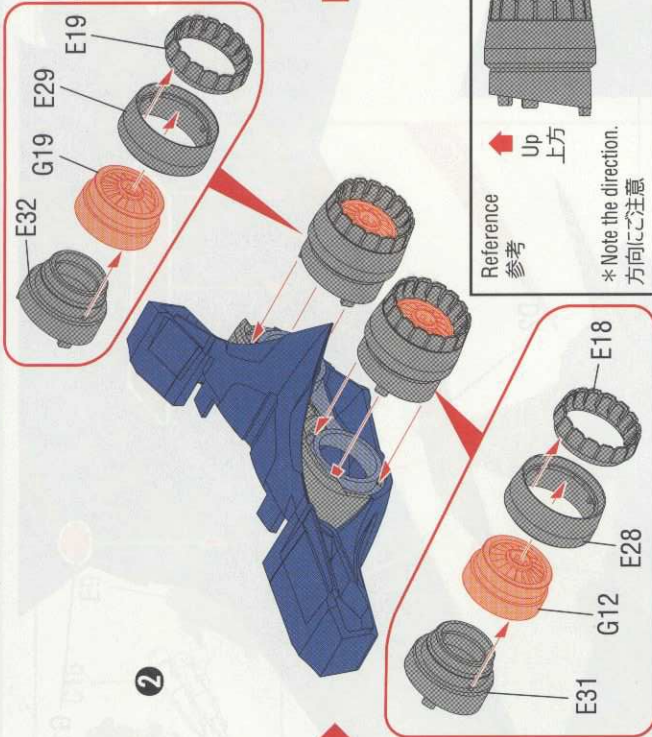

3

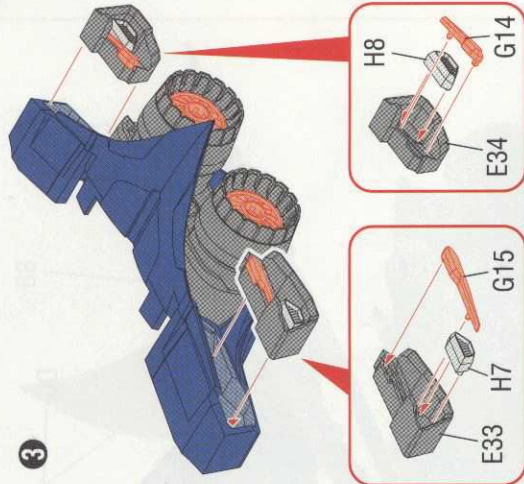

4

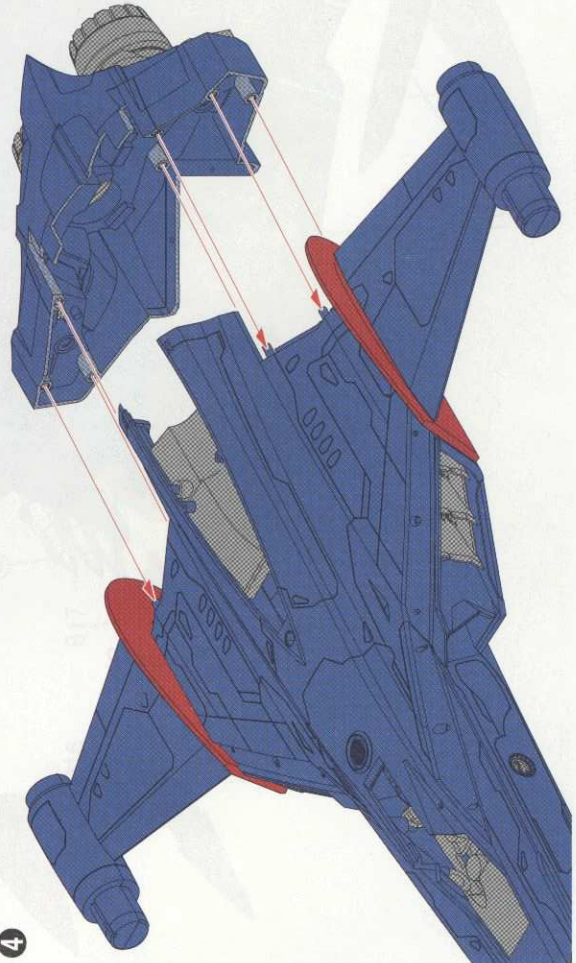

5

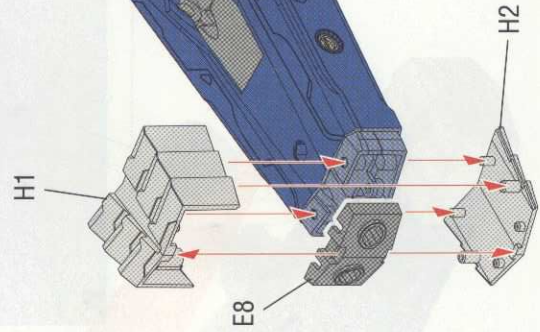

9

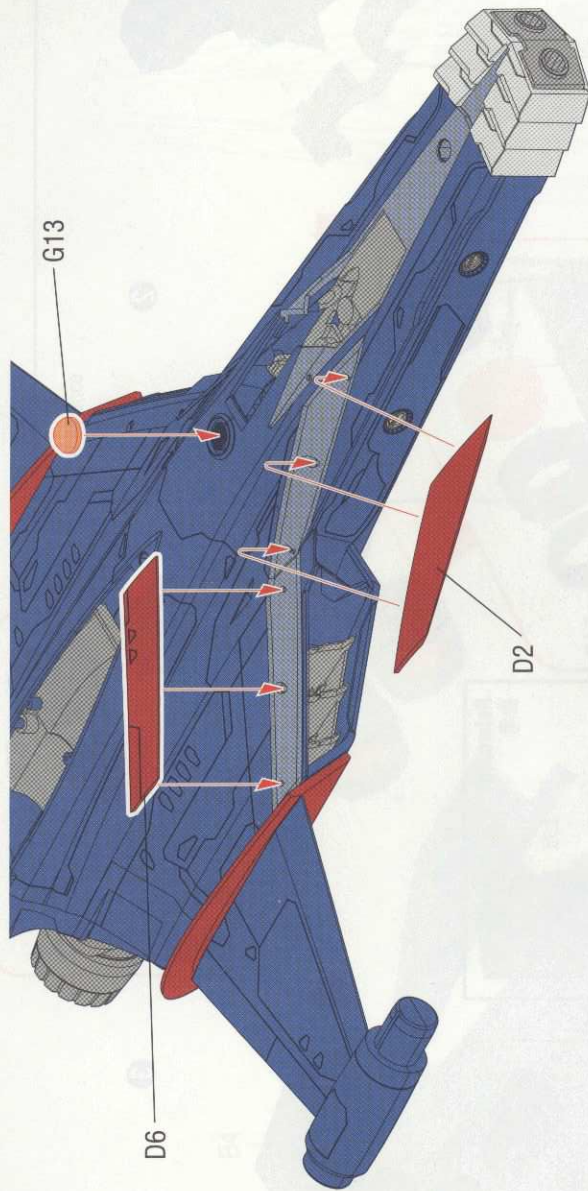

10

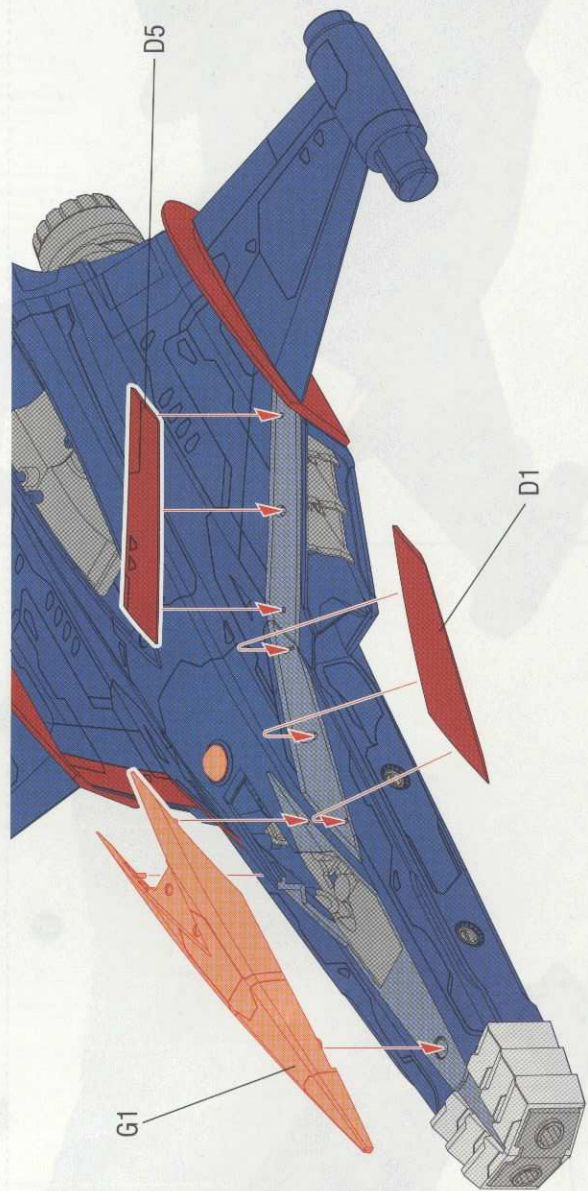

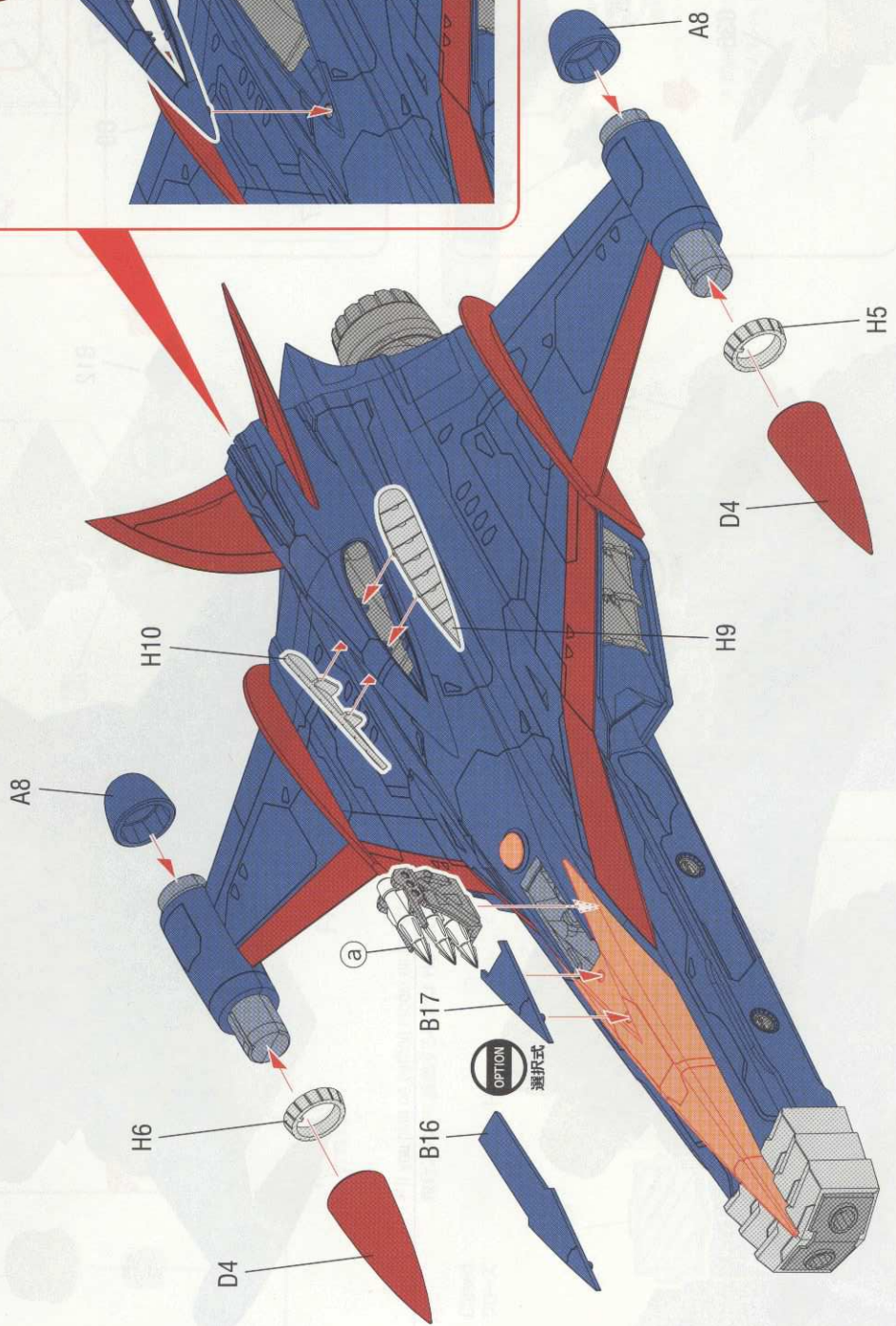
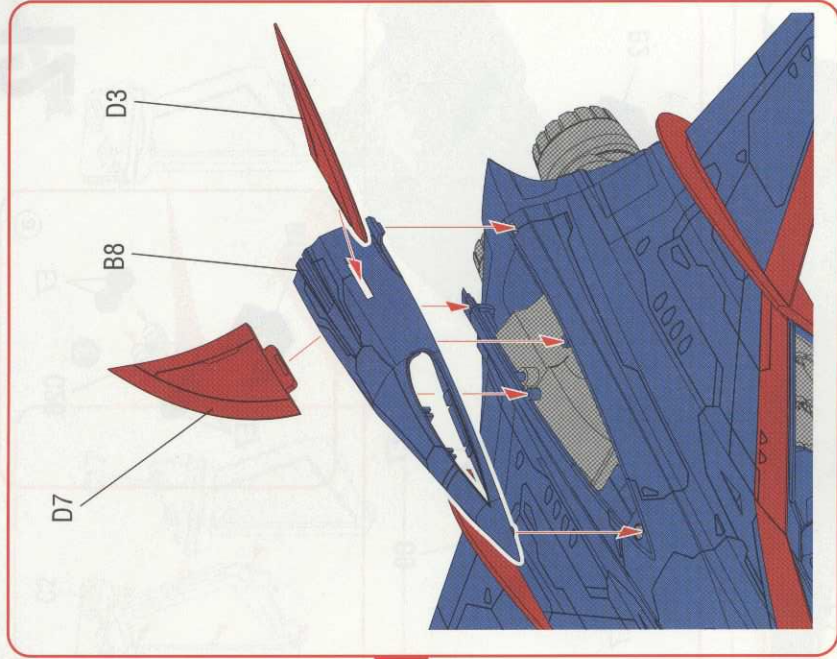
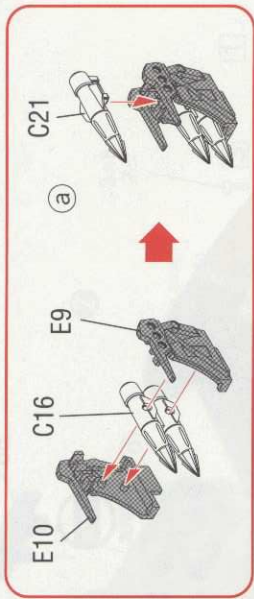

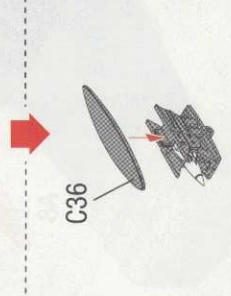
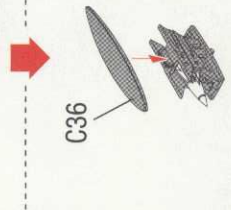
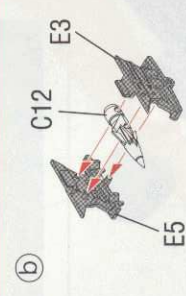
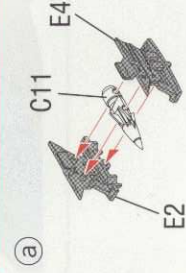
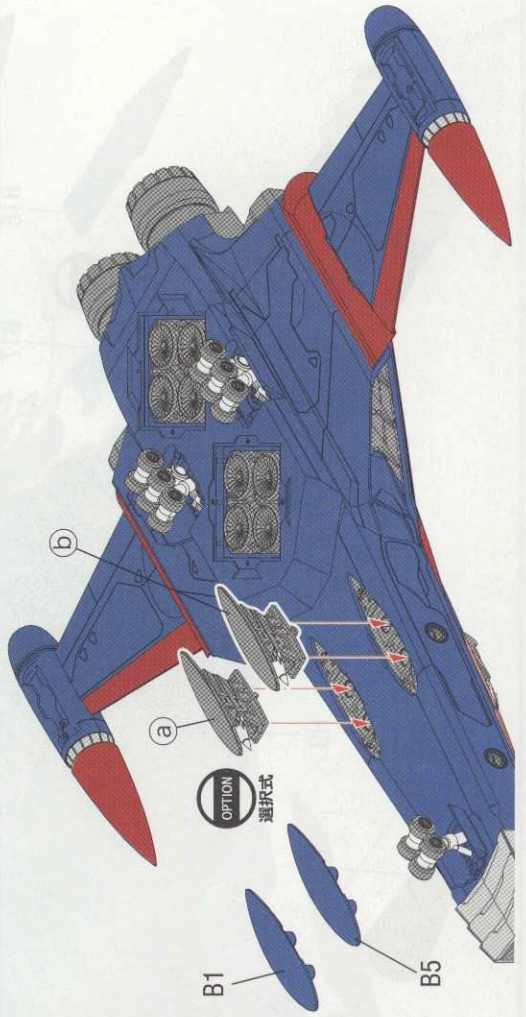
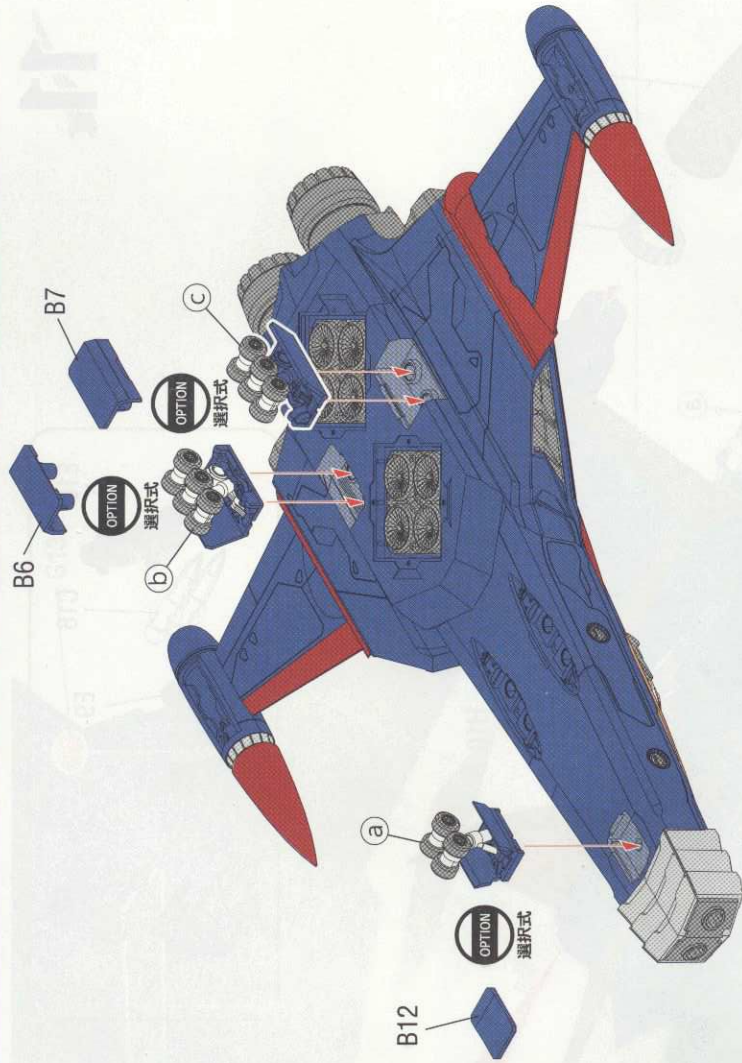
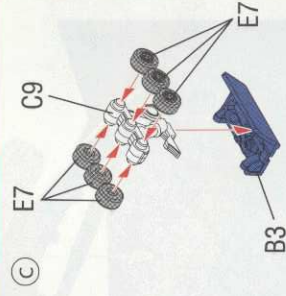
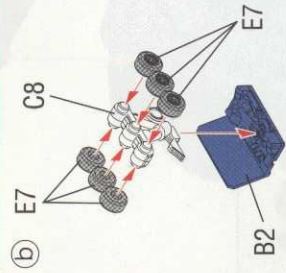
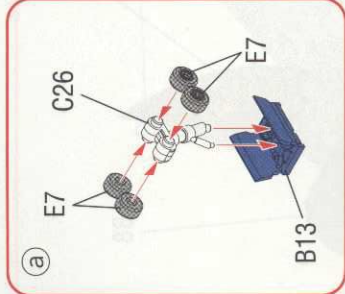

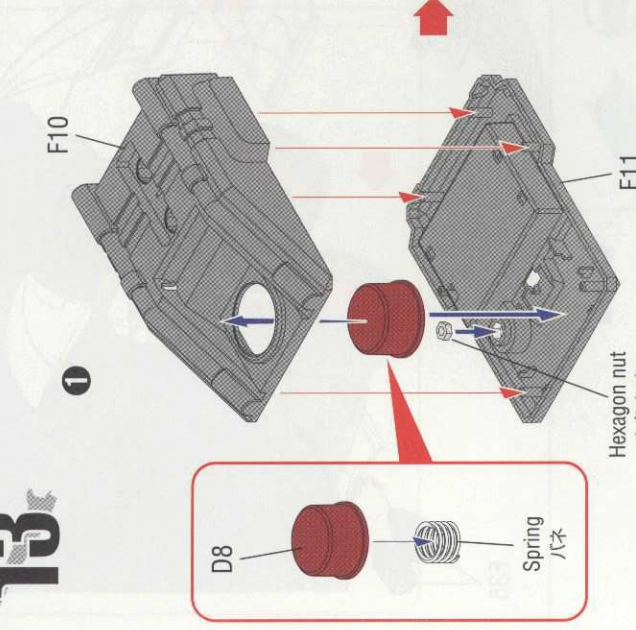
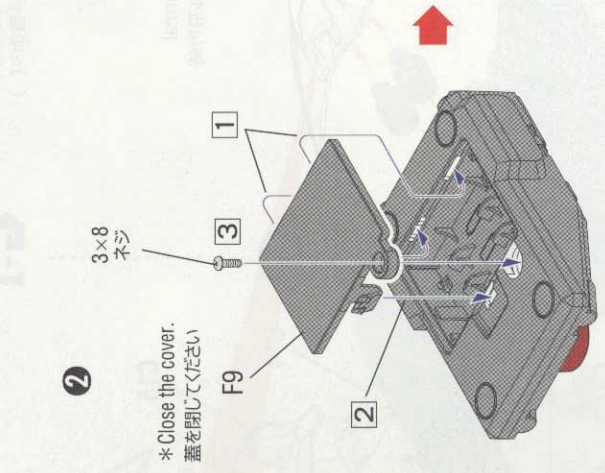
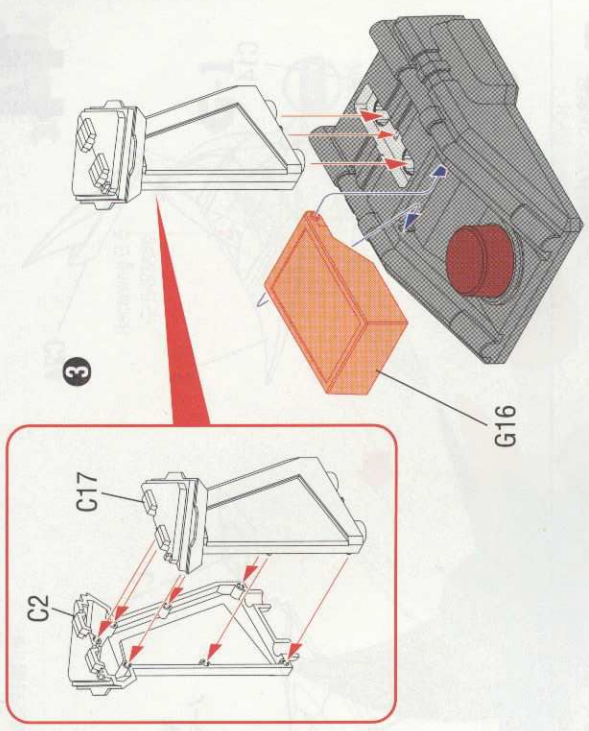

* If you plan on putting model on the stand, don't assemble part <H3> or <H4>
飛行スタンドに設置する場合は H3 または H4 部品が使用できません。

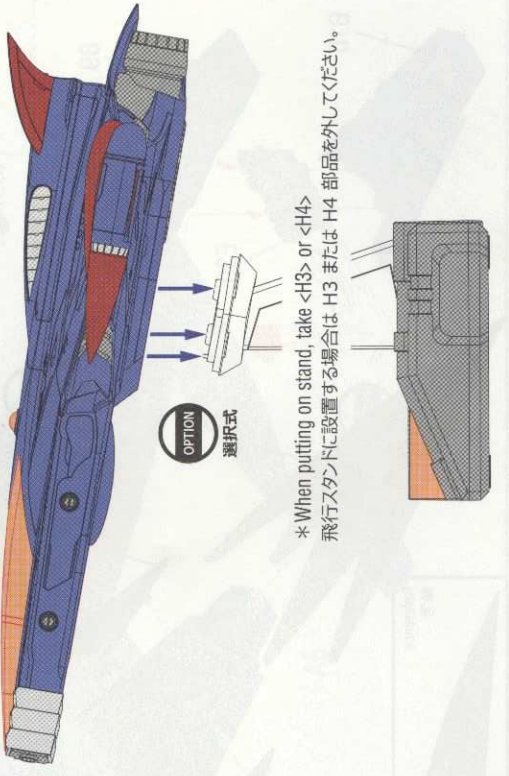

* When putting on stand, take <H3> or <H4>
飛行スタンドに設置する場合は H3 または H4 部品を外してください。

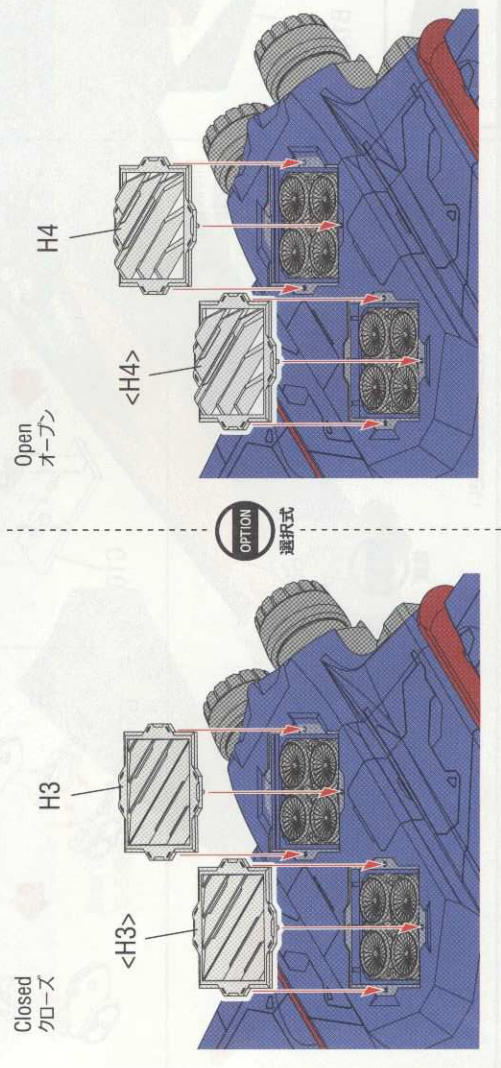

G-1

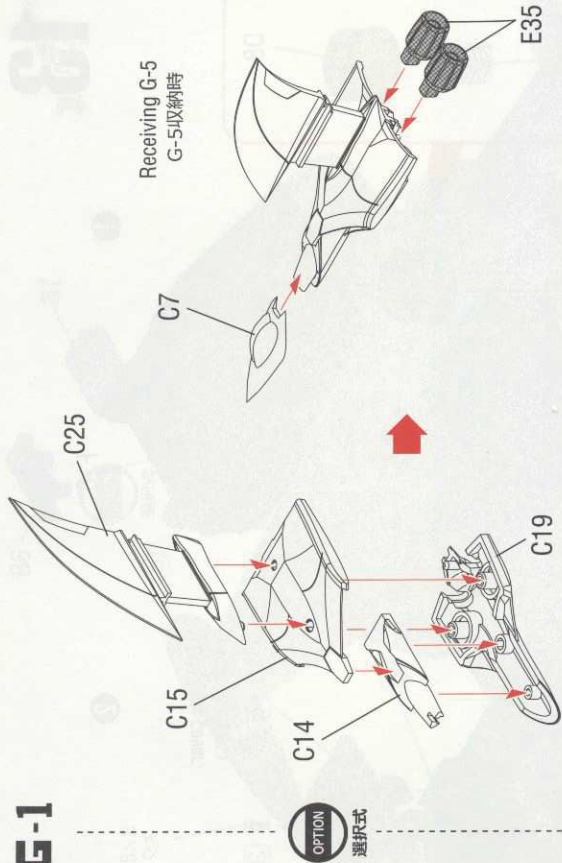

Normal
ノーマル飛行時

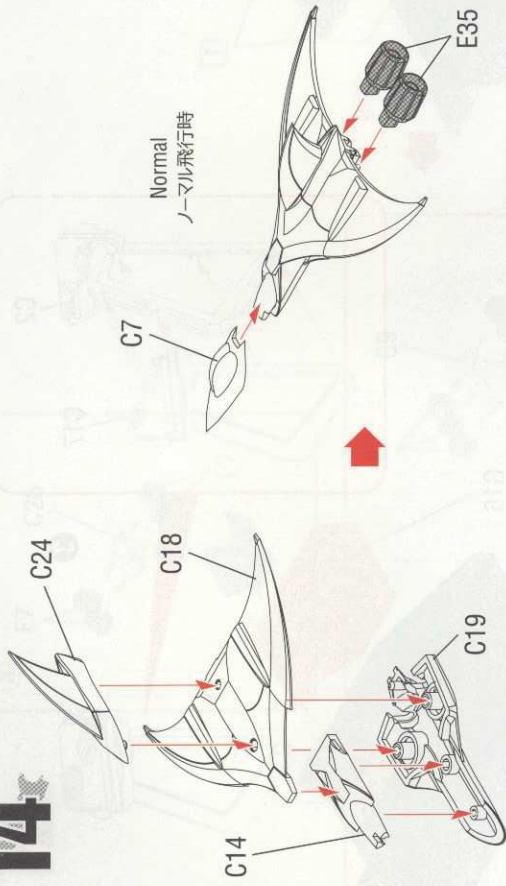

G-2

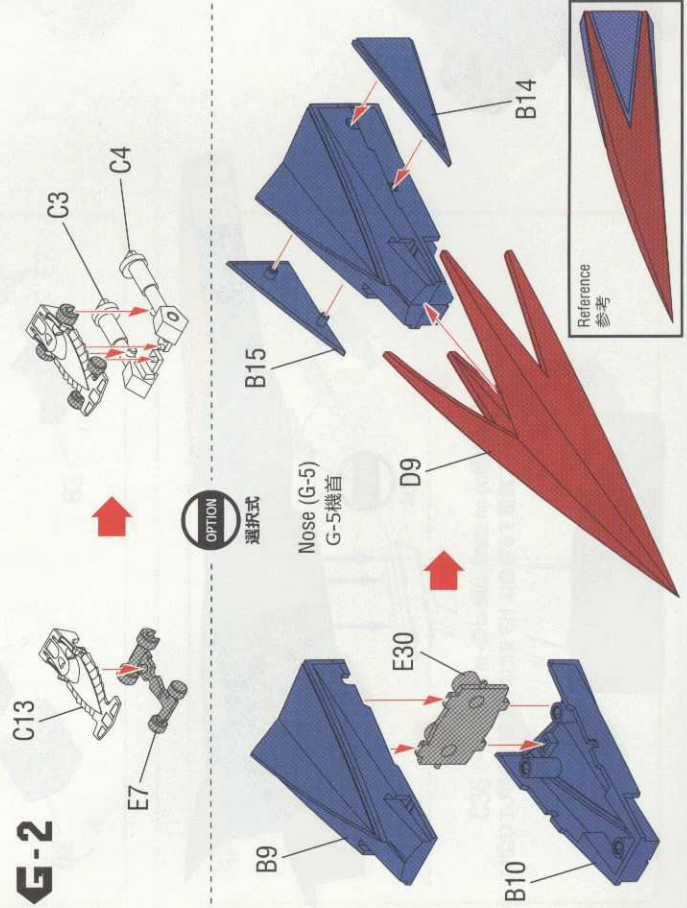

G-3

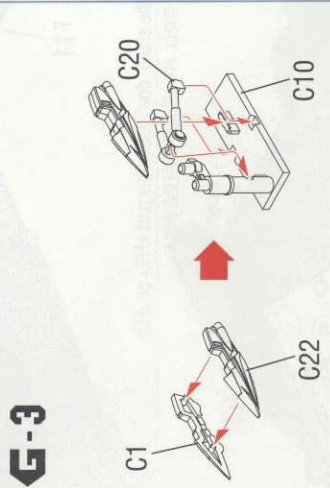

G-4

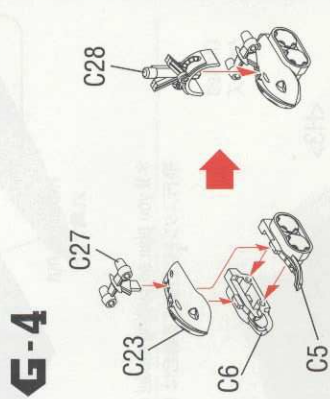

Effect parts (G-5)
G-5噴射炎フライト部品

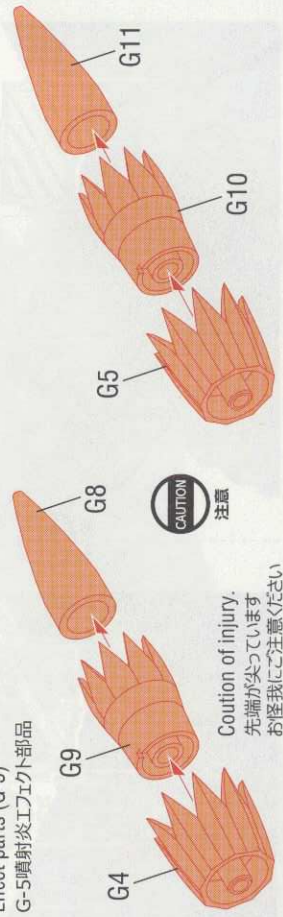

Caution of injury.
先端が尖っています
お怪我にご注意ください

* () part shown is for opposite side.
 ()内の番号は反対側です

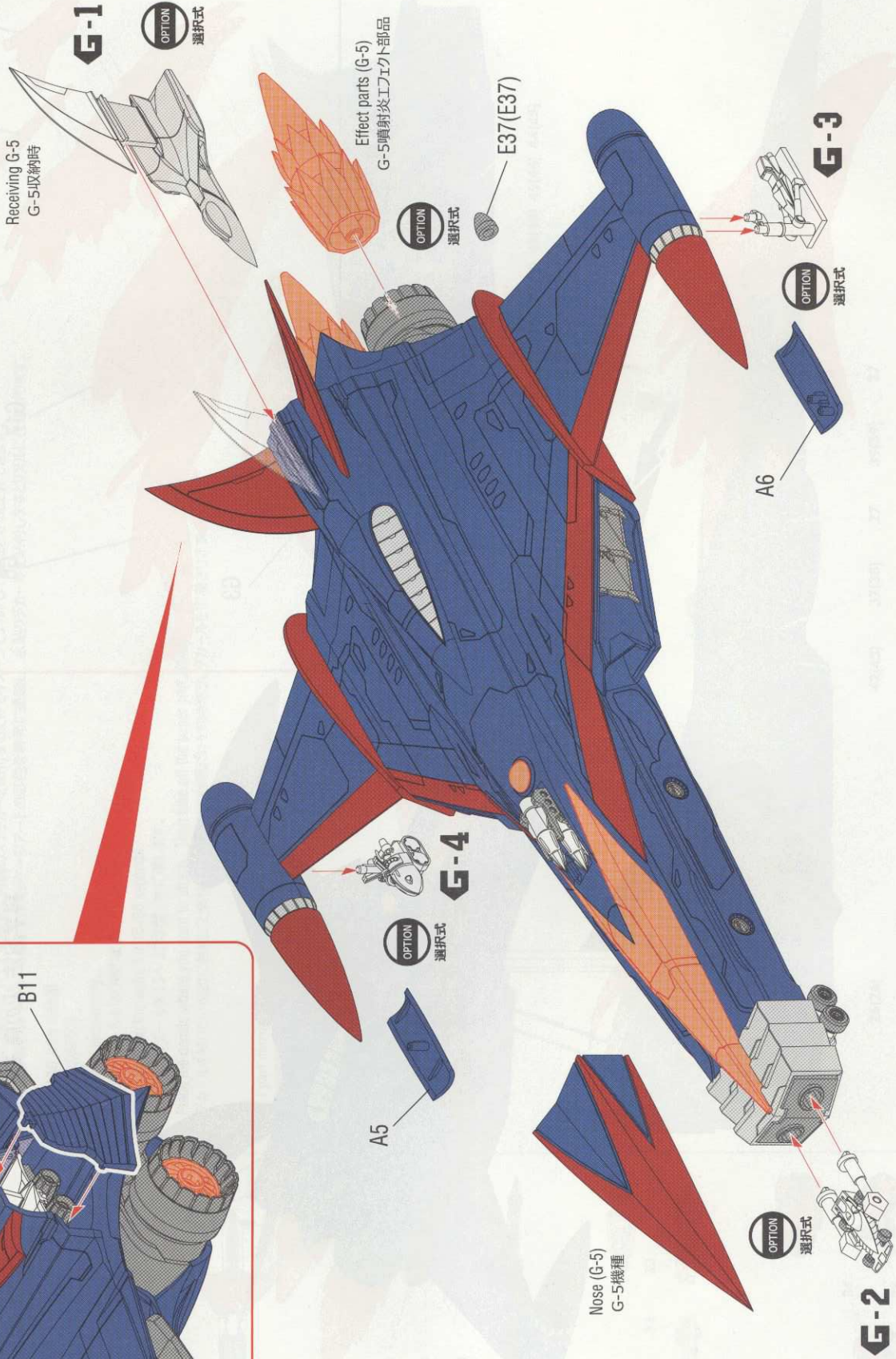
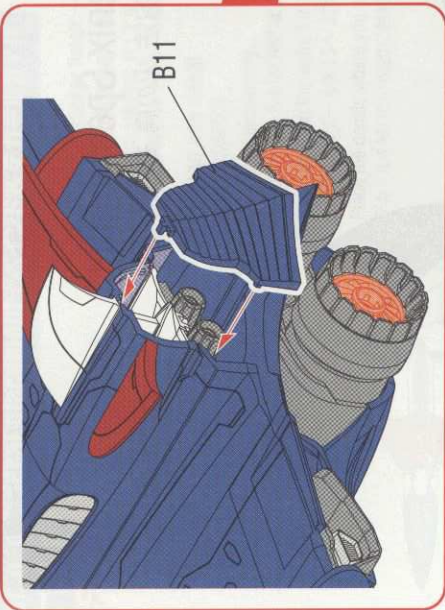

God Phoenix Special Effect

科学忍法 火の鳥モード

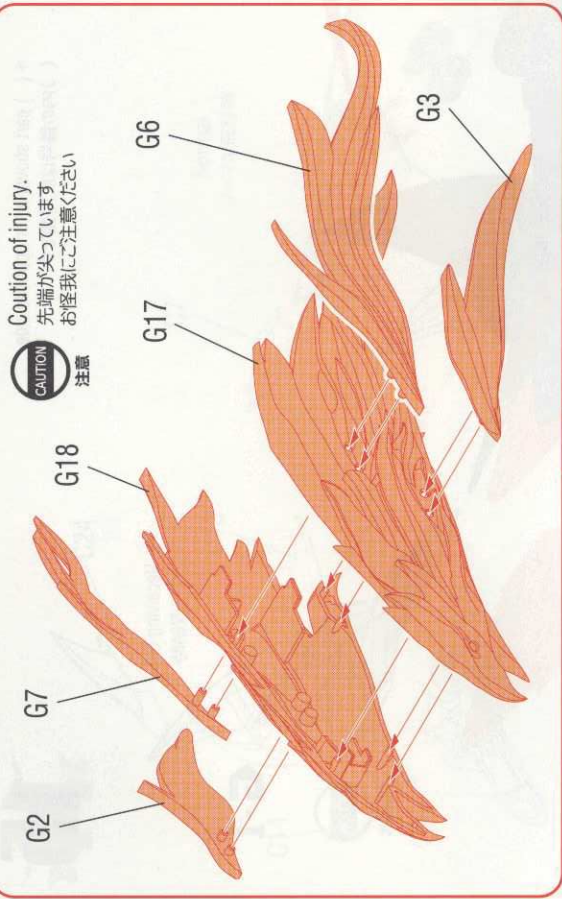
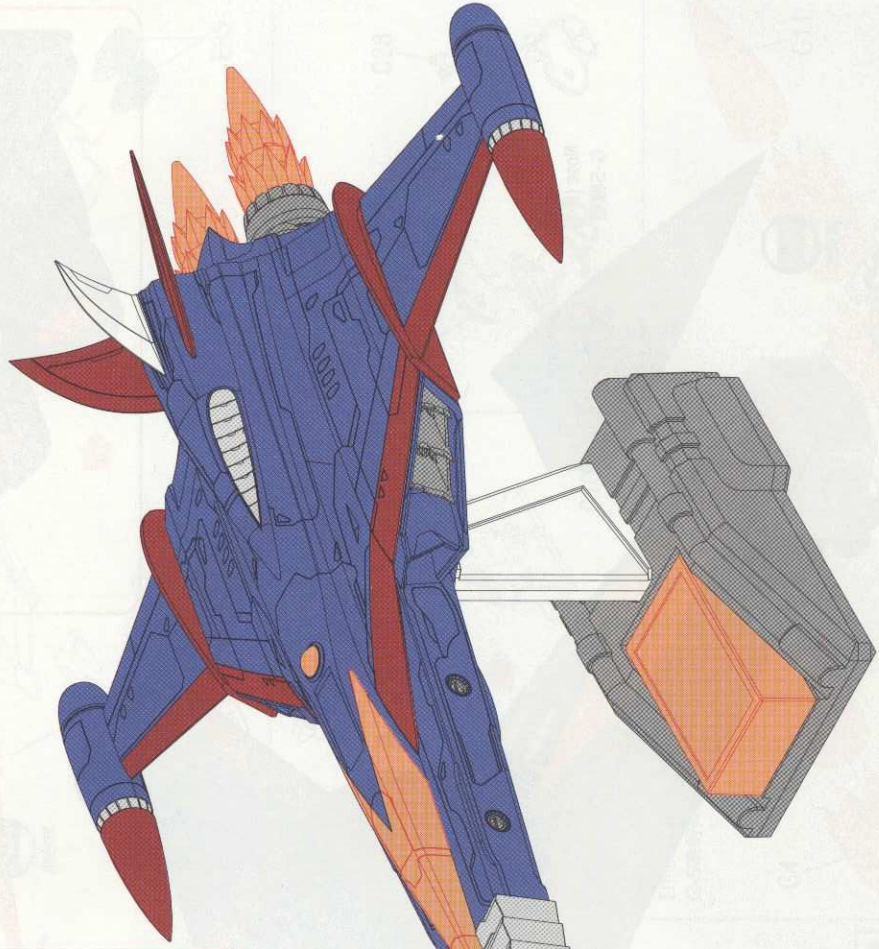

Painting & decal placement / ペイント&デカールガイド

F-1

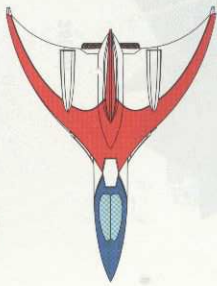
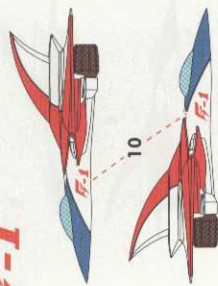

F-2

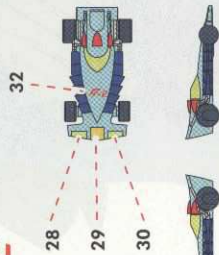

F-3



F-4

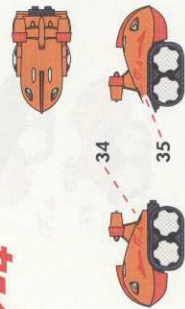

Unpainted & sticker finish → P.17

本キットは多色成型部品 (MCP/マルチカラーパーツ) で構成されています。塗装を施さない場合は P.17 を参考に付属のステッカーを貼付するだけでイメージモデルとして完成させることができます。塗装を施す場合は P.15~16 およびパッケージアートの彩色を参考に塗装し、水貼りデカールを貼付しますとリアルに仕上がります。

●How to use decal デカールの貼り方

1. Cut decals individually.
貼りたいデカールを切り取ります。
2. Soak decals in the water for 15~30 seconds.
切り取ったデカールを15~30秒間、水に浸します。
3. Place the decals where you want to attach. Then take off the paper part slowly.
デカールを貼りたい位置に台紙ごと乗せ、スライドさせて台紙だけを抜き取り、デカールを定着させます。

* () part shown is for opposite side.
()内の番号は反対側です

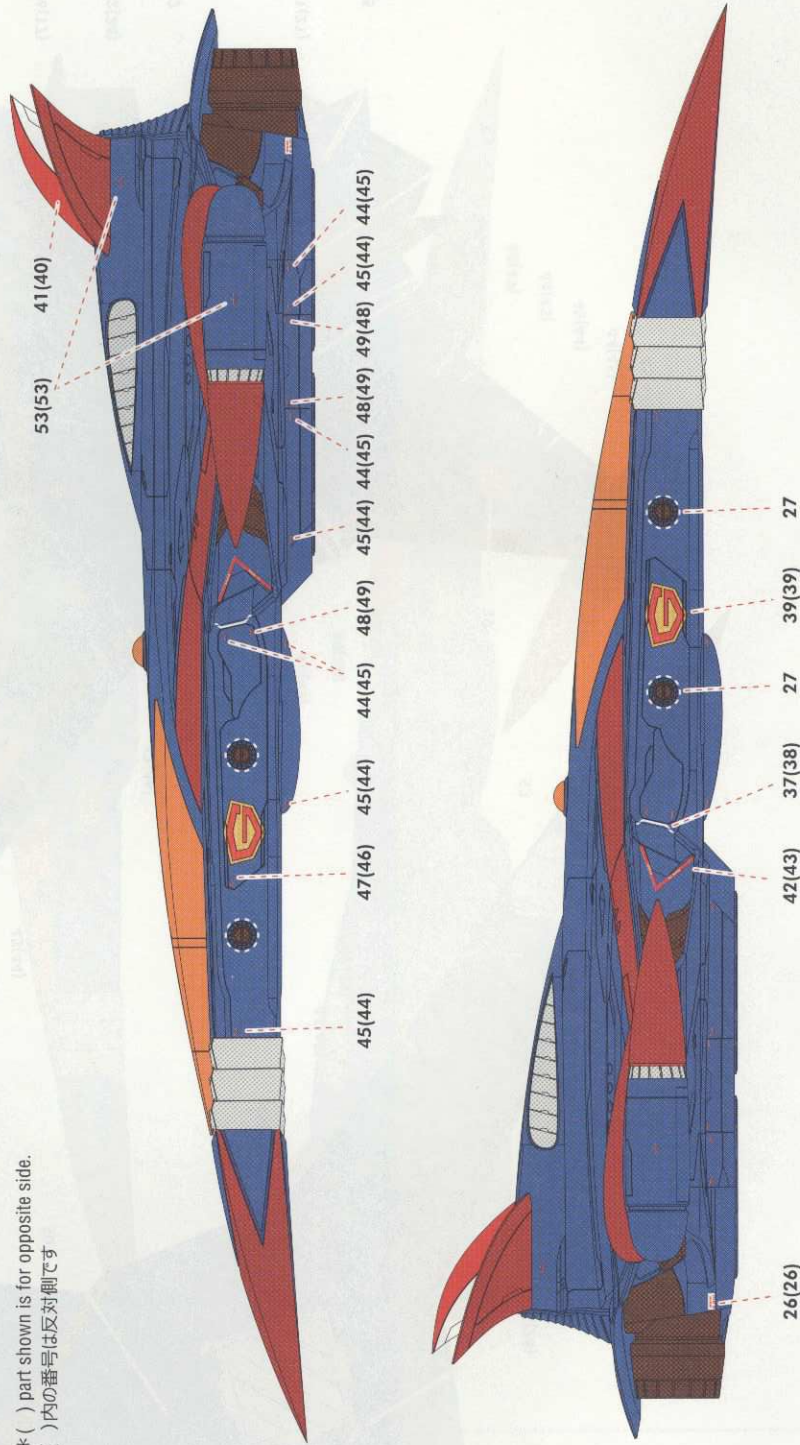

Painting & decal placement / ペイント&デカールガイド

* () part shown is for opposite side.
 () 内の番号は反対側です

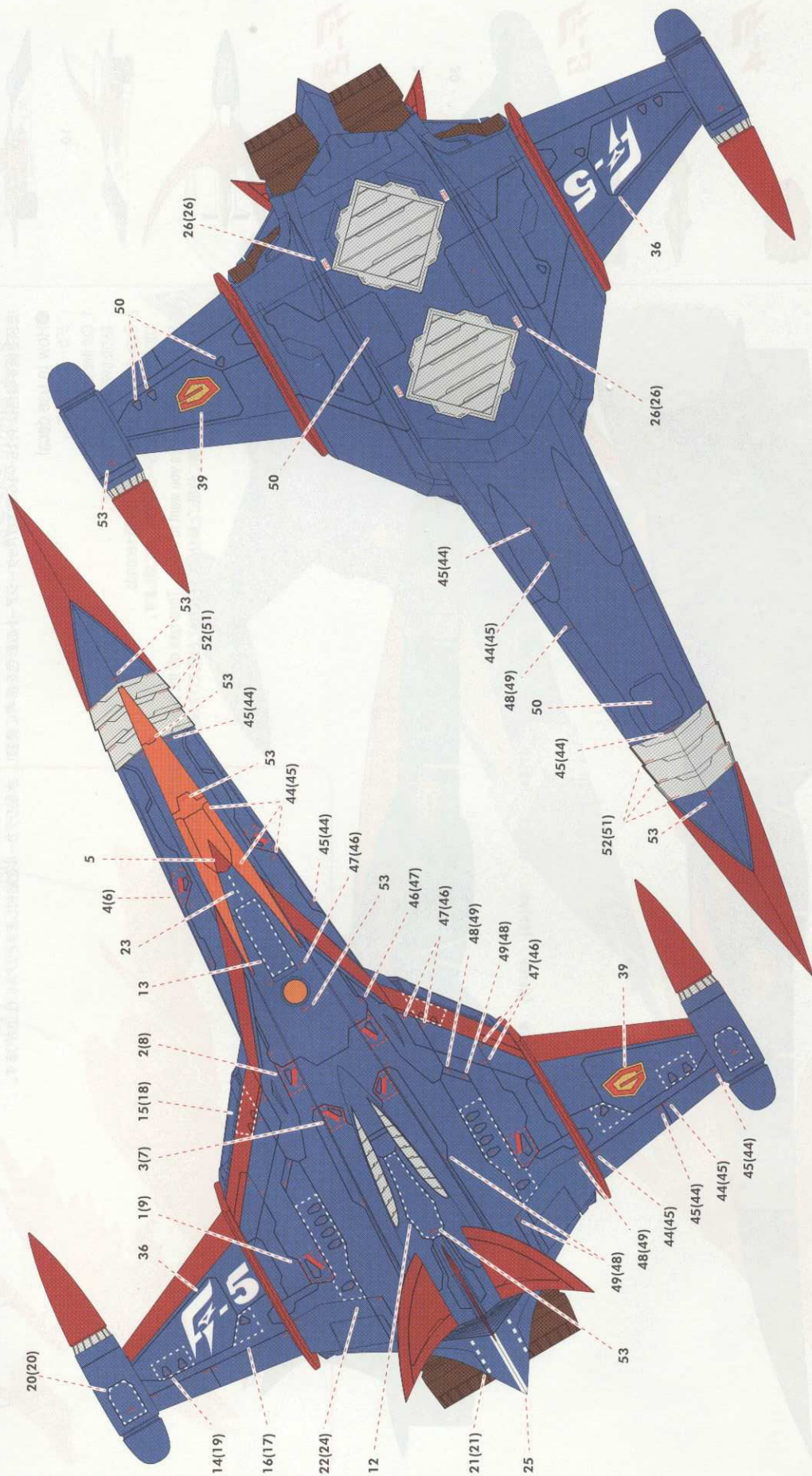

Sticker placement / ステッカーガイド

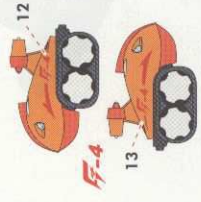
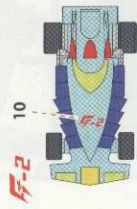

* For sticker, just attached where you want, not using water.
ステッカーは水へ浸けず、台紙から剥離してそのまま貼ります。

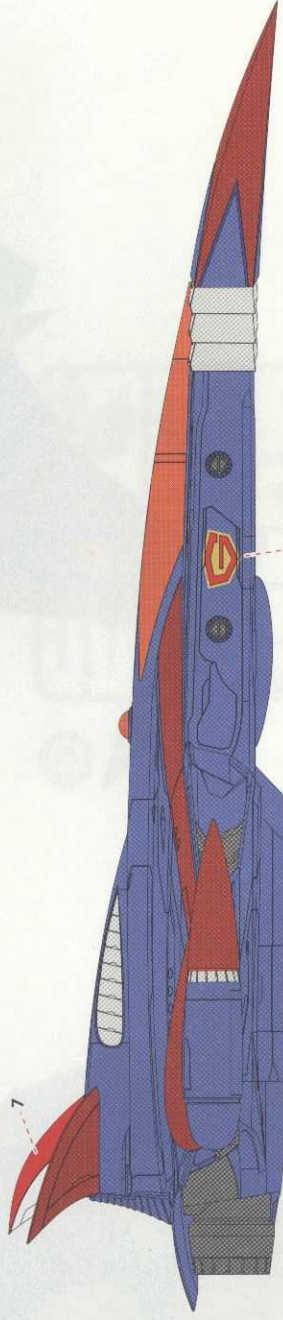

Sticker placement / ステッカーガイド

* For sticker, just attached where you want, not using water.
ステッカーは水へ浸けず、台紙から剥離してそのまま貼ります。



Parts location diagram / 部品图

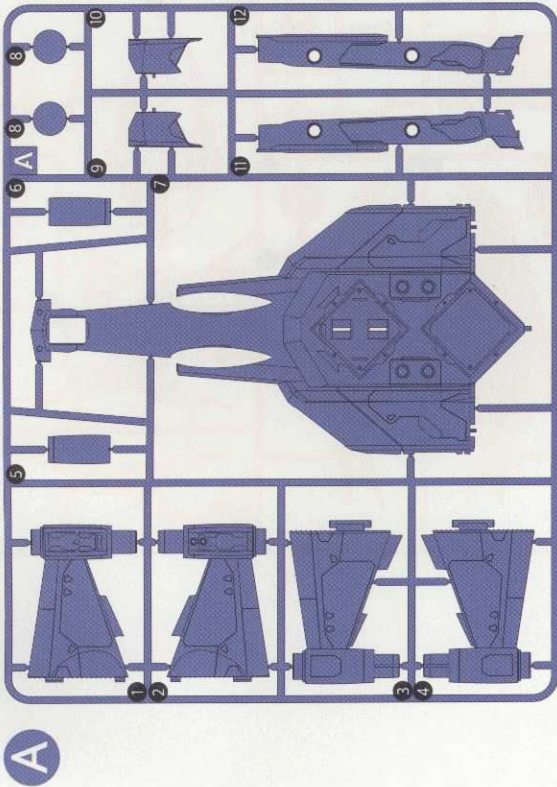

A

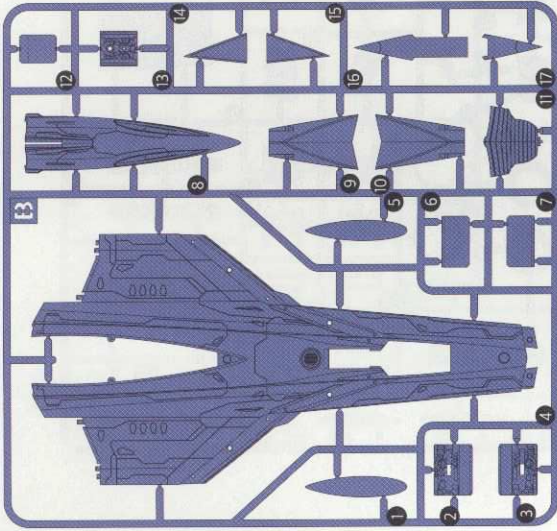

B

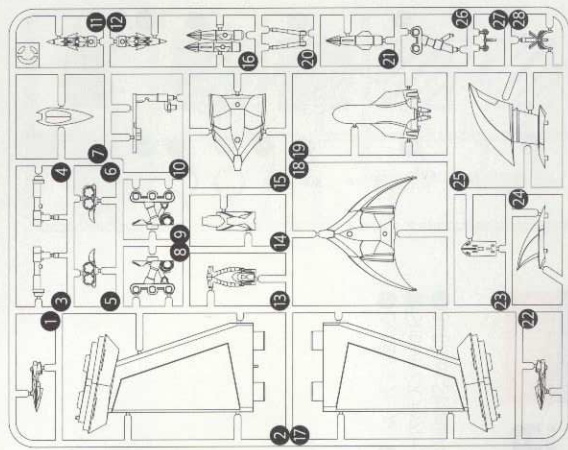

C

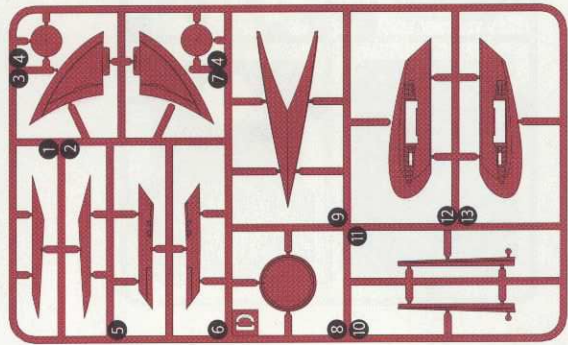

D

Parts location diagram / 部品図

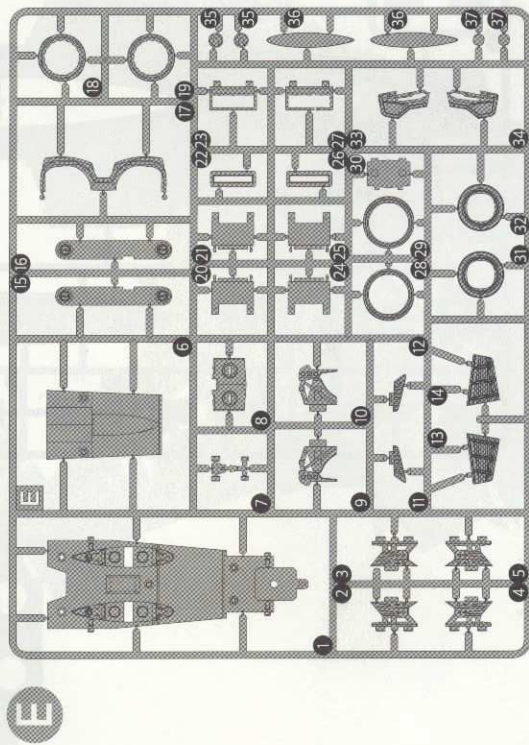

G

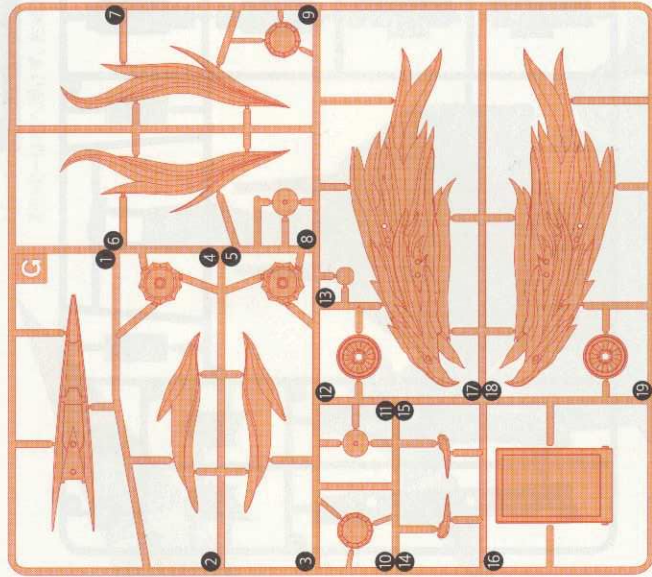

F

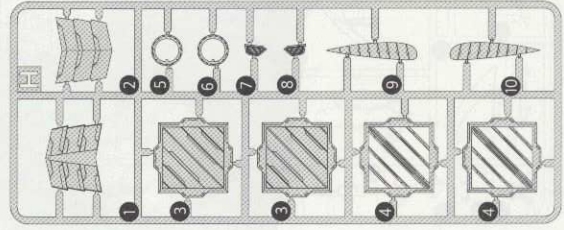
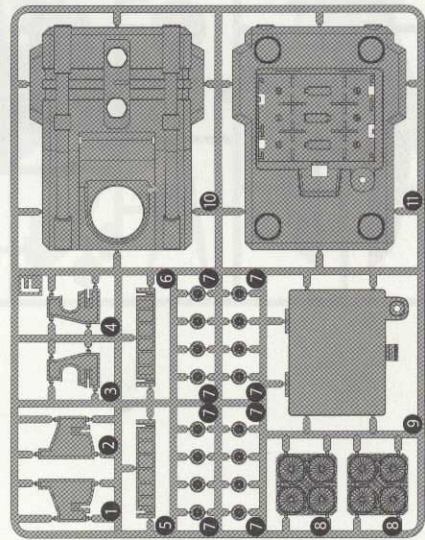

- Decal/デカール
- Sticker/ステッカー
- 3×8mm Screw/ネジ
- Hexagon nut/六角ナット
- Spring/バネ

ACADEMY
HOBBY MODEL KITS

ACADEMY
ACADEMY PLASTIC MODEL CO., LTD.
A/S 고래선터 대표번호: 1988-2406