

METALCUBE

3D laser cut models

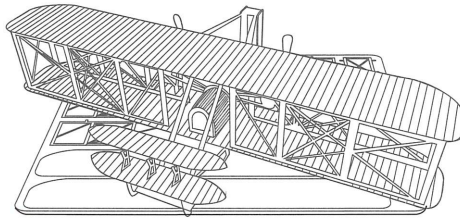

It is highly recommended that you visit to see the completed model before assembling your own



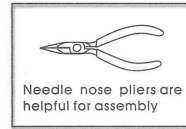
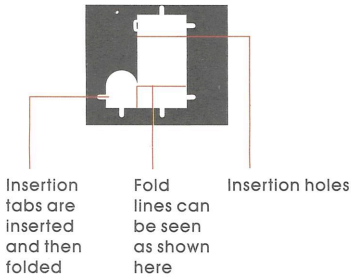

mms042



Metal sheet

To create the best connections

 Insert tab and bend 90 degrees for most visible areas

 Insert tab and twist 90 degrees is best in some areas to ensure a tight connection

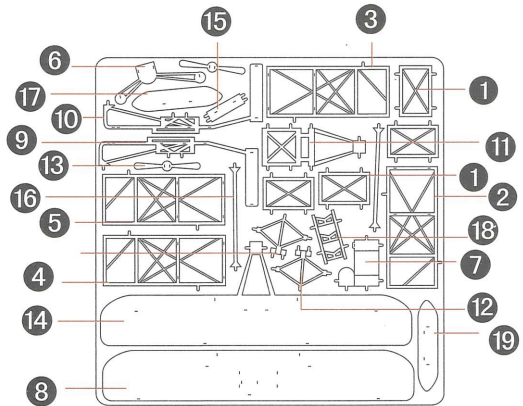
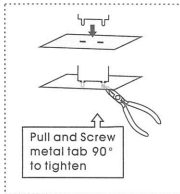

In order to avoid possible injury from sharp edges, please carefully discard the metal sheet after parts have been removed

Assembly Flow Chart

