

Tiger I Initial

Sd.Kfz.181 Pz.Kpfw.VI Ausf.E Initial Production
s.Pz.Abt 502, No.100 (Eared Tiger)



1 : 72
TK 7205

虎式重型坦克初期型
(100号耳朵虎)

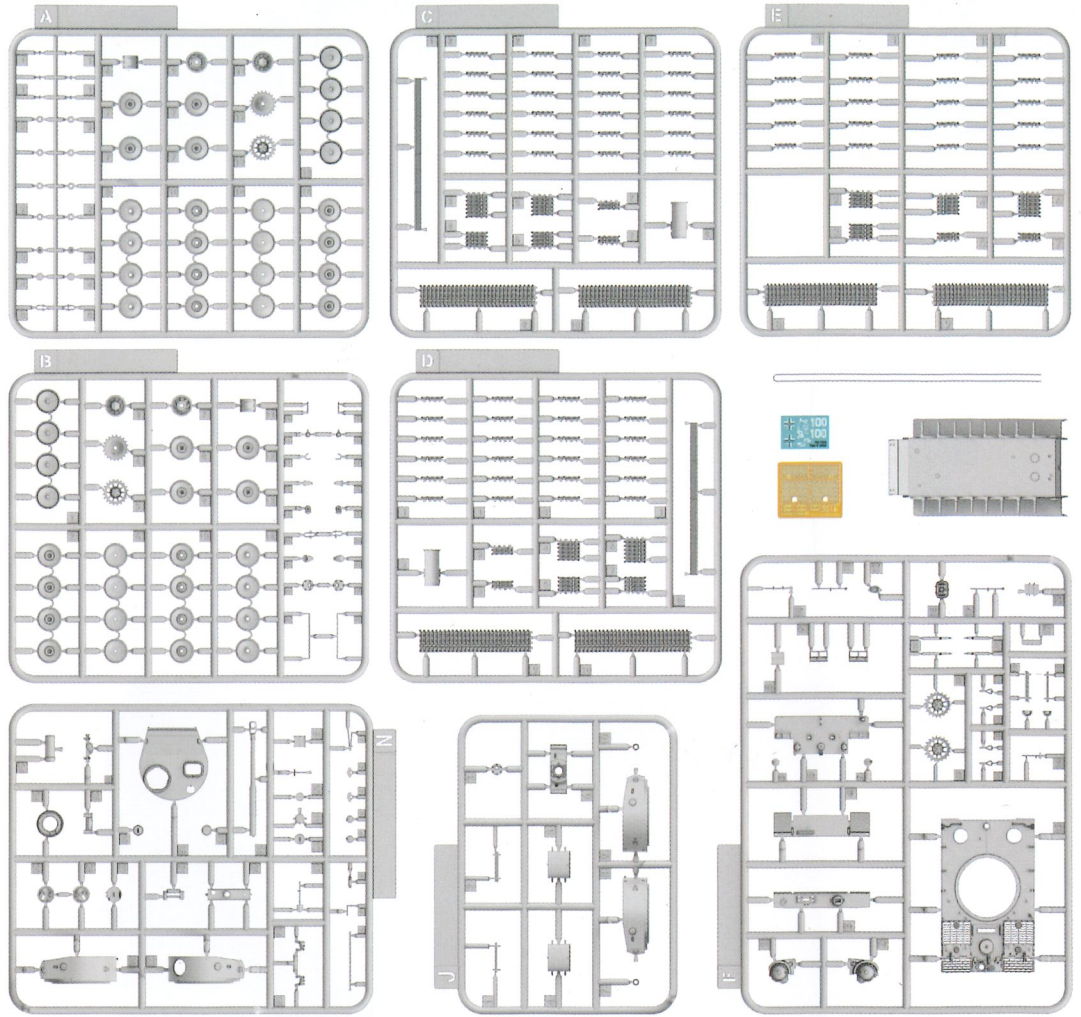

- 

DRILL HOLE
开孔
- 

FILL HOLE
填孔
- 

REMOVE
去除
- 

OPTIONAL
可选择
- 

BE CAREFUL
注意
- 

NO GLUE
不用胶水
- 

INSTANT CEMENT
瞬干胶
- 

BEND
折弯

Painting Scheme

CP008
黑色
Black

BRASS
黄铜
Brass



CV025
RAL6006
田野灰
Field Grey

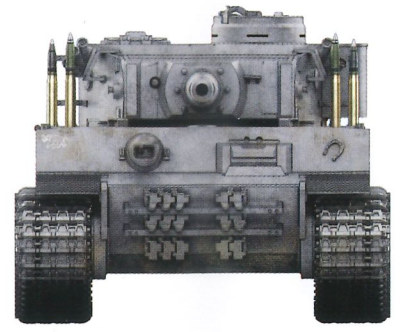

S1

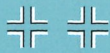

100 100

Leningrad Region, Fall 1942
列宁格勒地区, 1942年秋

CV003

RAL7021
德国黑灰
Black Grey

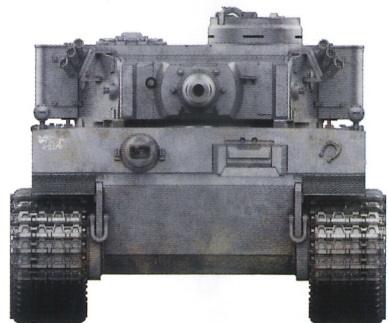
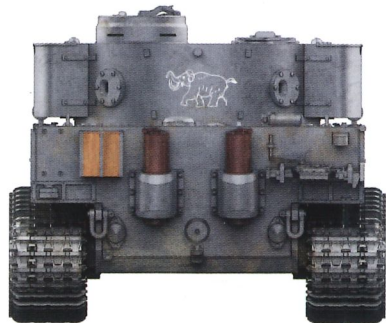
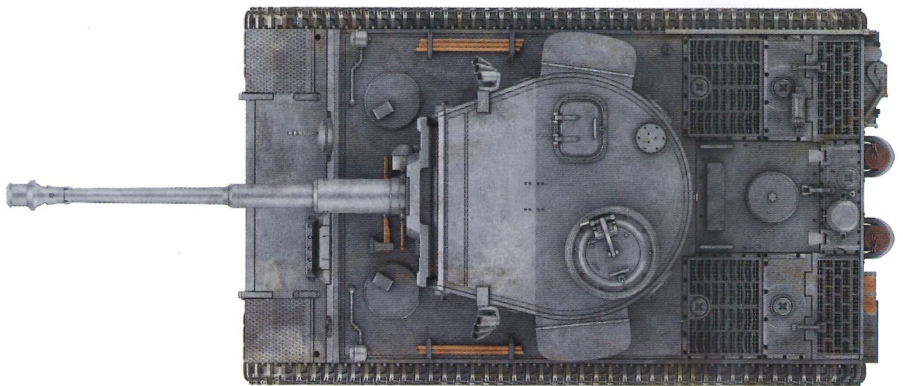
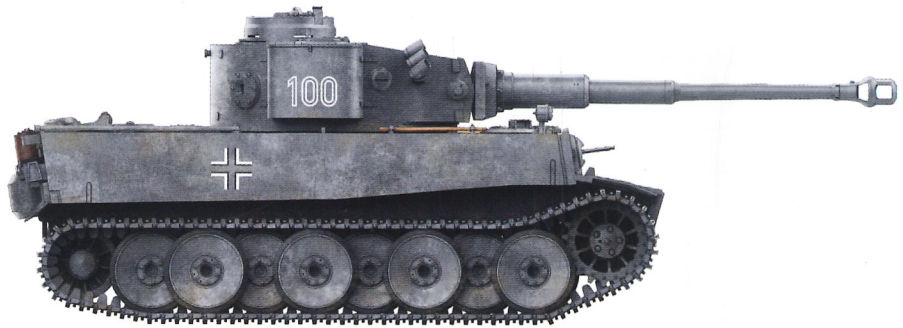
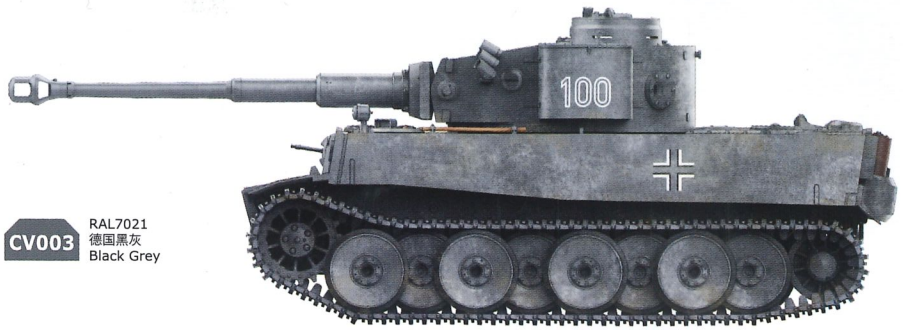

S2

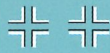

100 100

Leningrad Region, 1942~43
列宁格勒地区, 1942-1943的冬季

CU107

RAL9002
水洗迷彩
Washable camo

CV003

RAL7021
德国黑灰
Black Grey

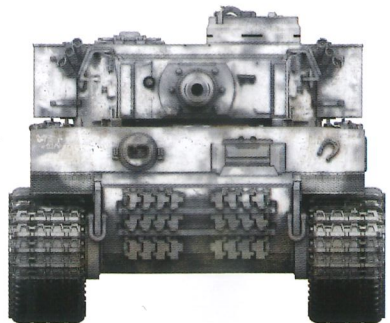
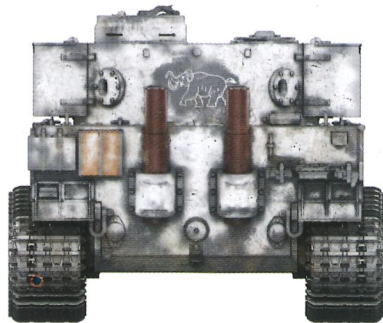
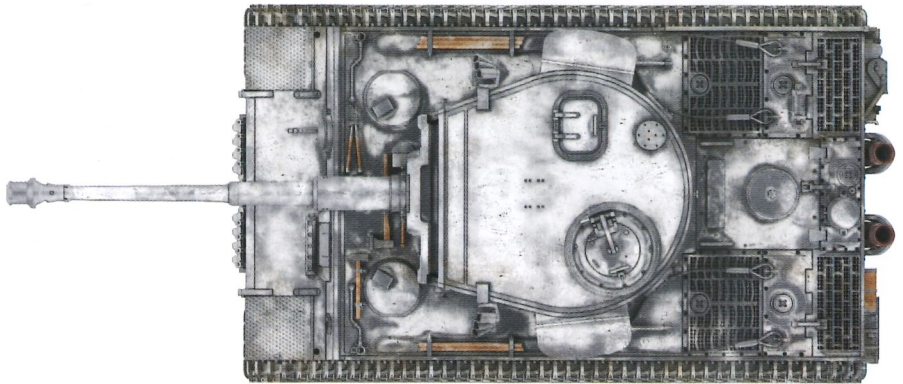
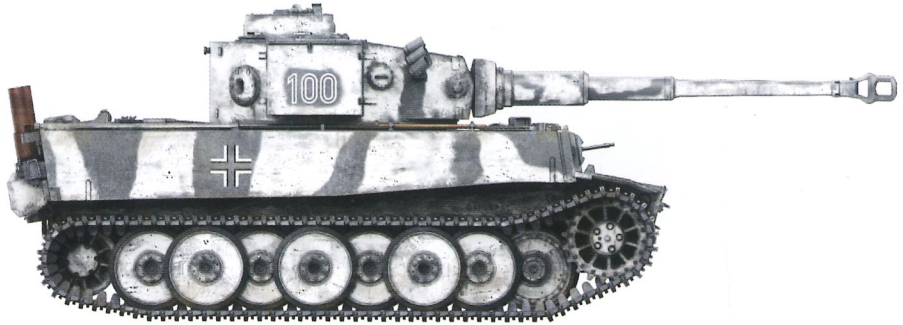
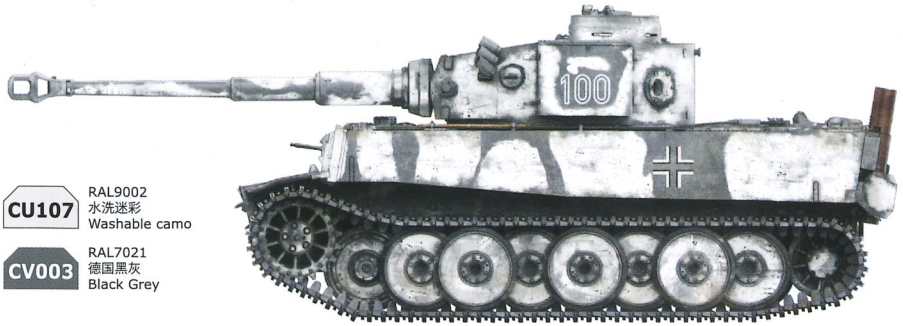

S3



Captured and displayed in Moscow, June 1943
被缴获并展示在莫斯科, 1943年六月

CV003L 德国黑灰(高光)
Black Grey (L)

CV003 德国黑灰
Black Grey

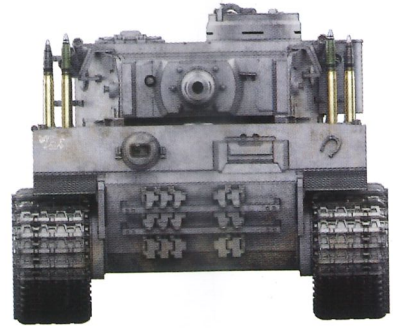
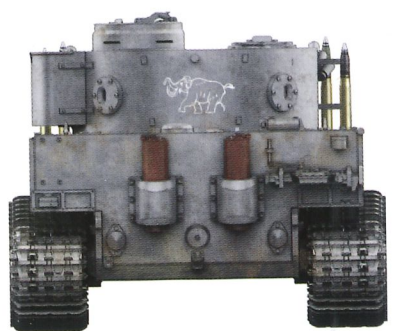
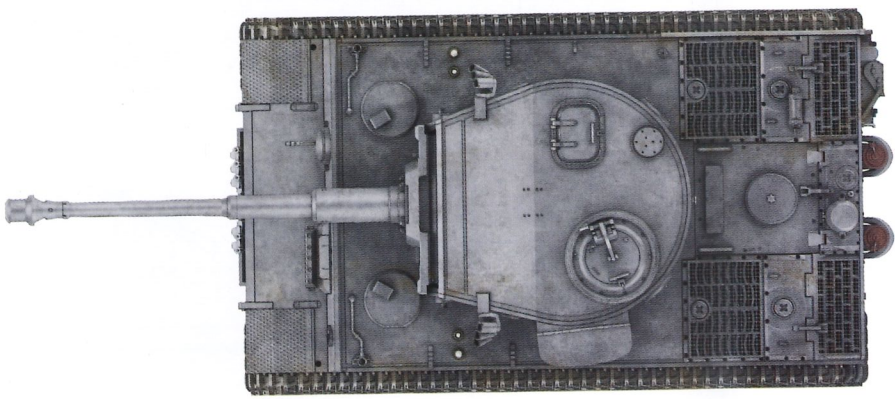
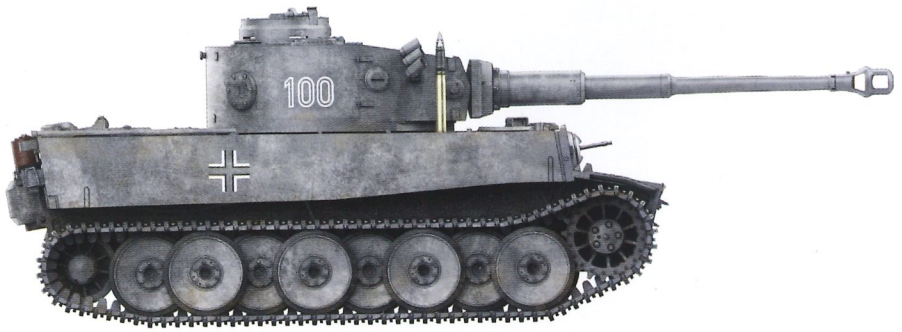
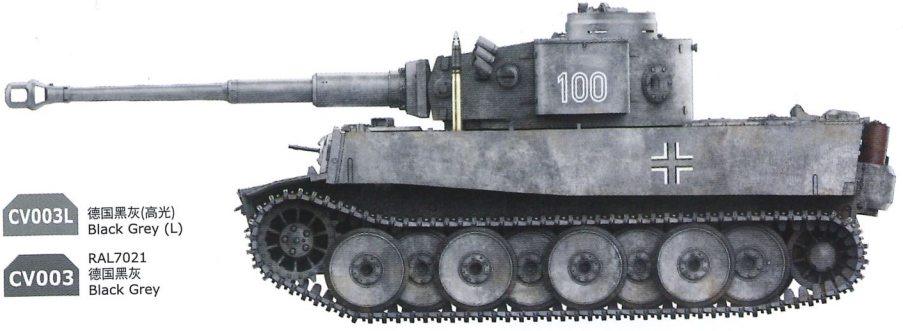

1

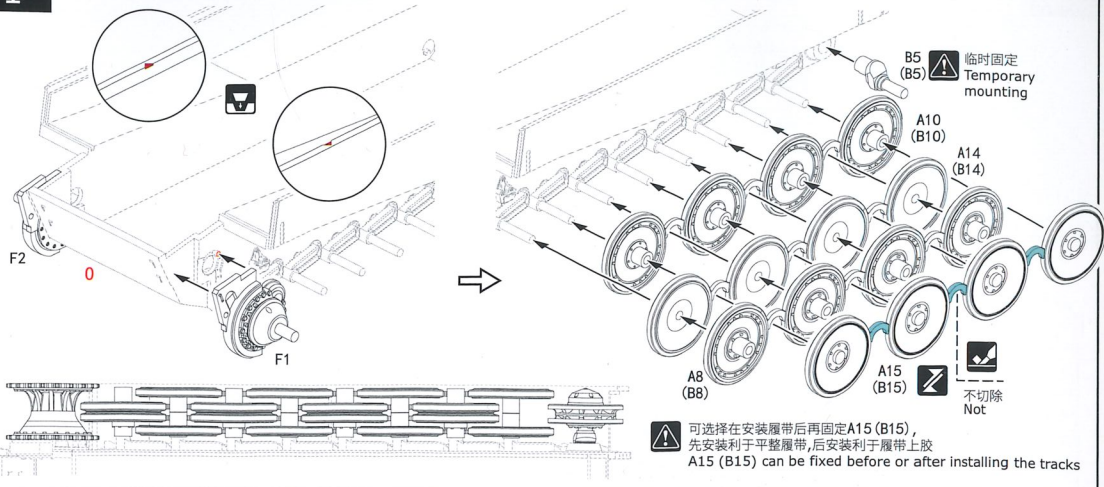

2

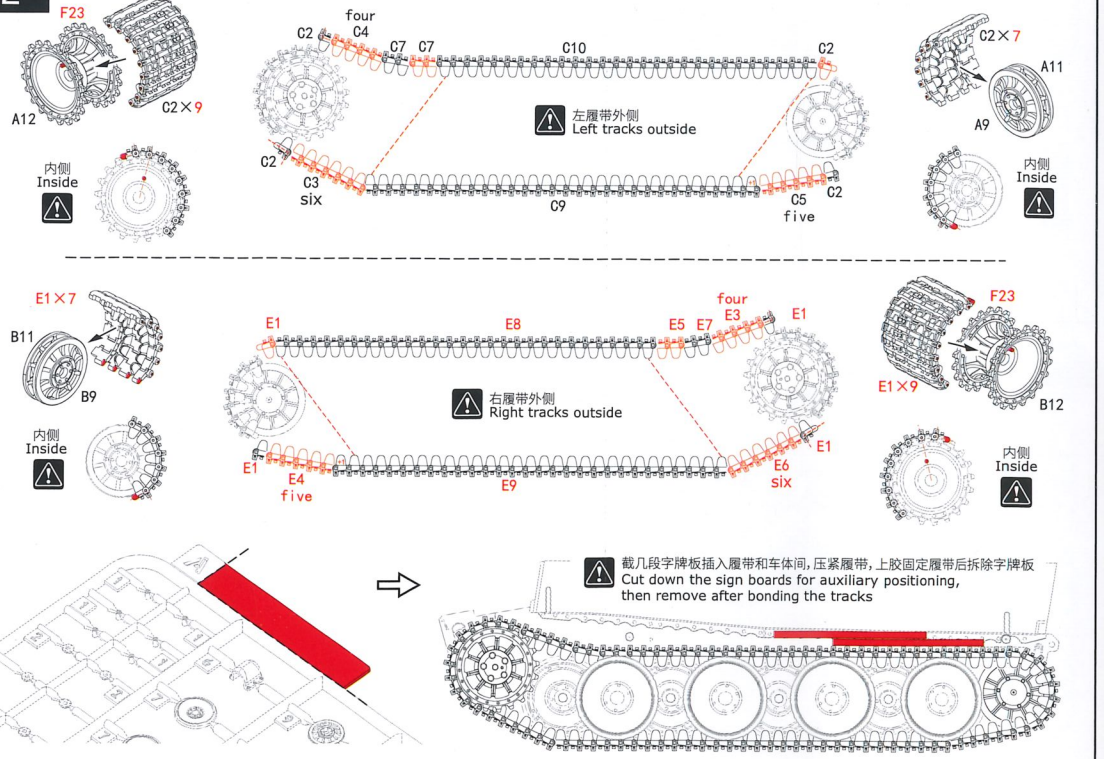

3

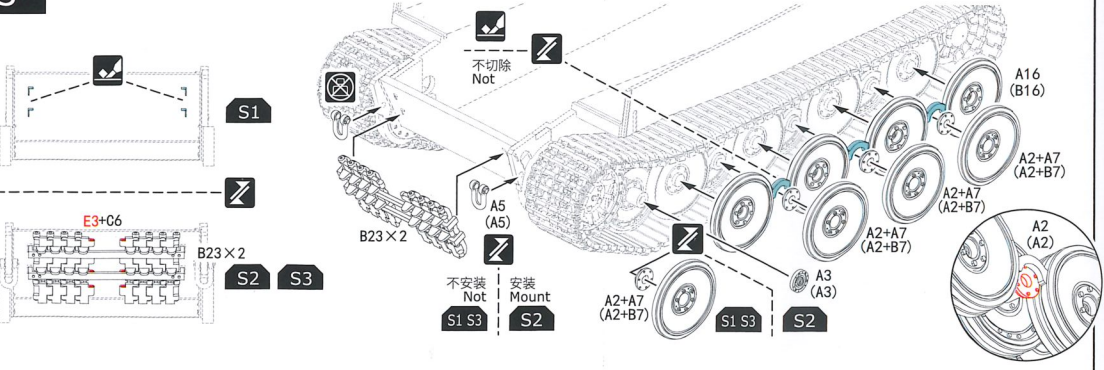

5

4

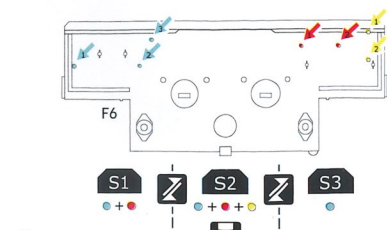
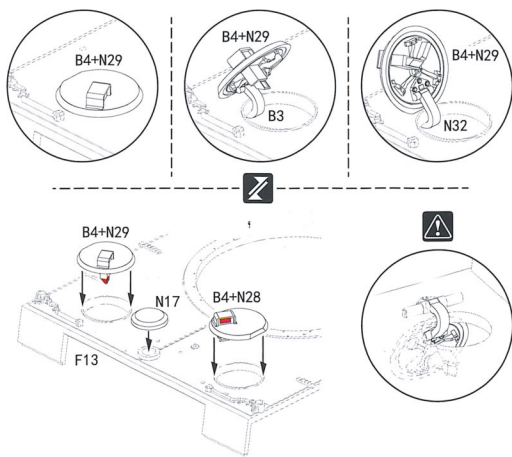
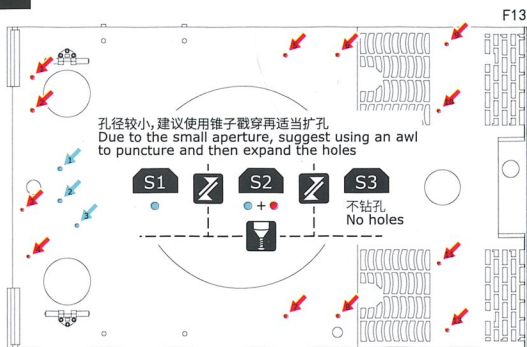

选择性钻孔并安装相应零件
Selective drilling and install corresponding parts

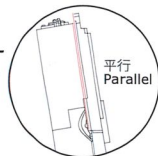
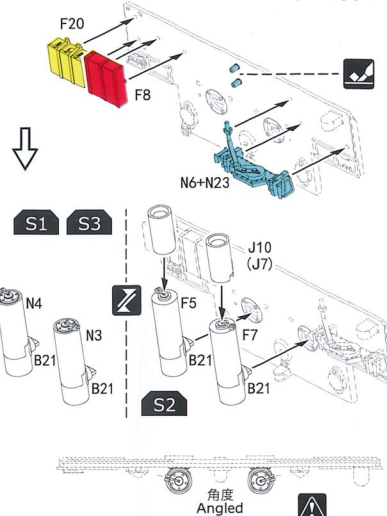

5

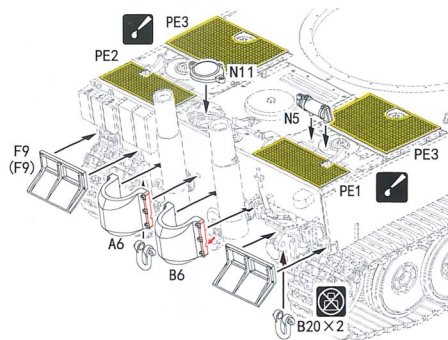
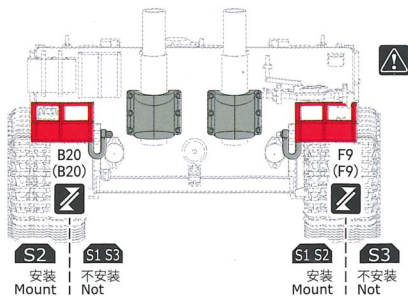
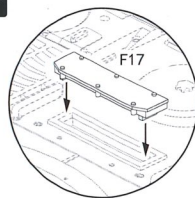
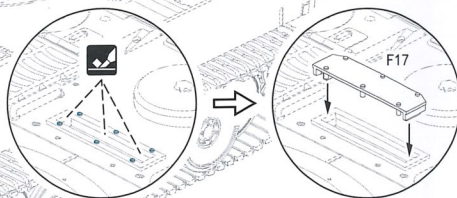
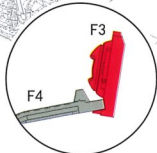
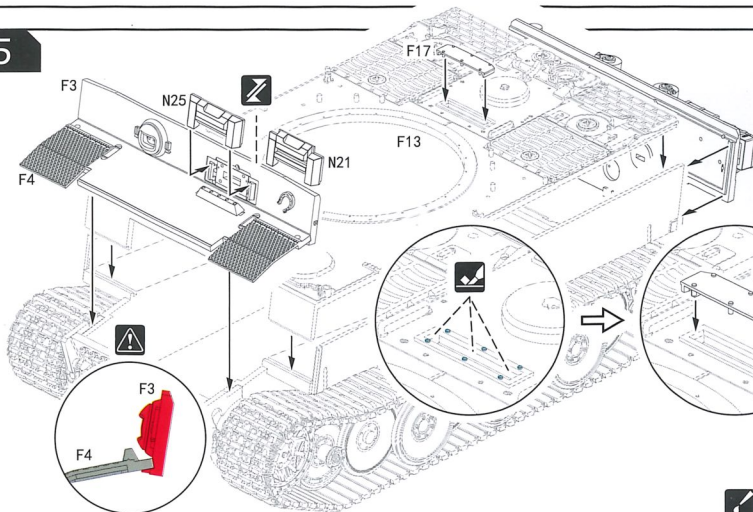

6

6

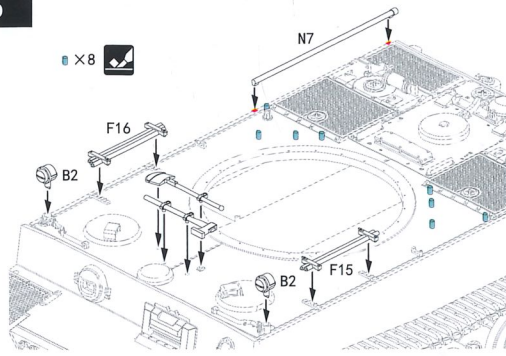

S1

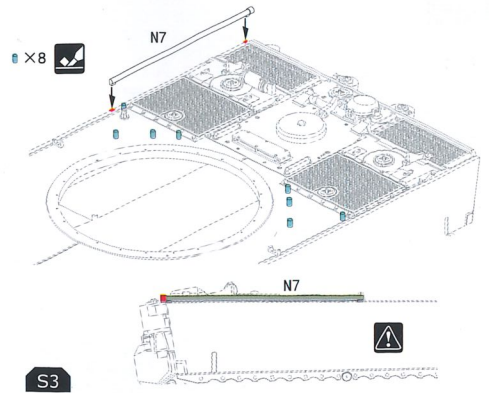

S3

■ x6 用于走向参考, 安装缆绳前去除
 For direction reference, remove
 before installing the cable

■ x2

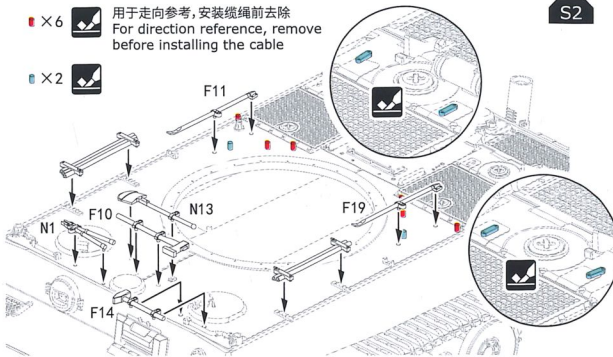

S2

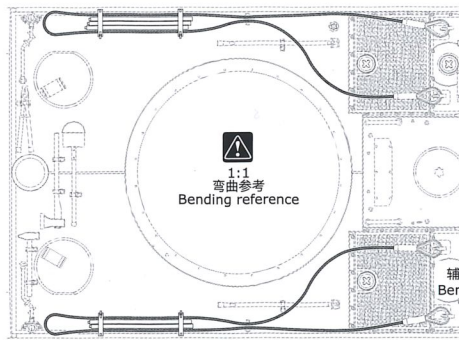
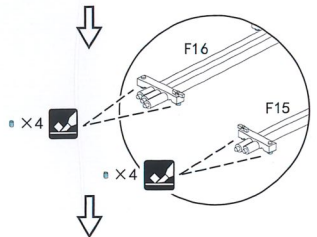
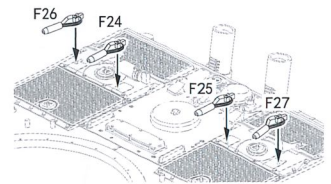

辅助弯曲治具, 安装后去除
 Bending fixture, remove
 after installation

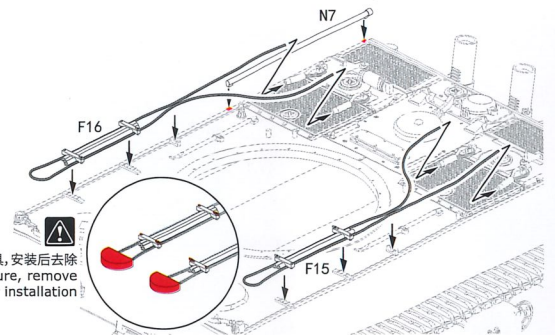

7

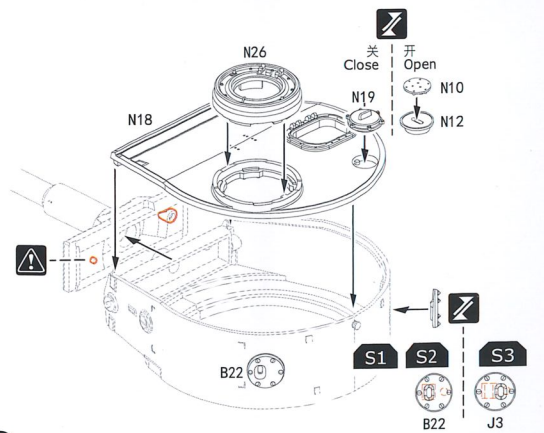
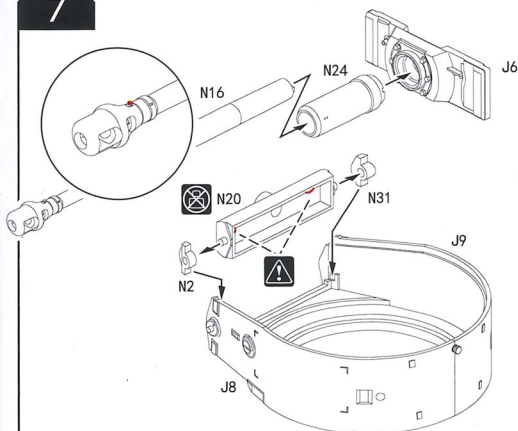

7

8

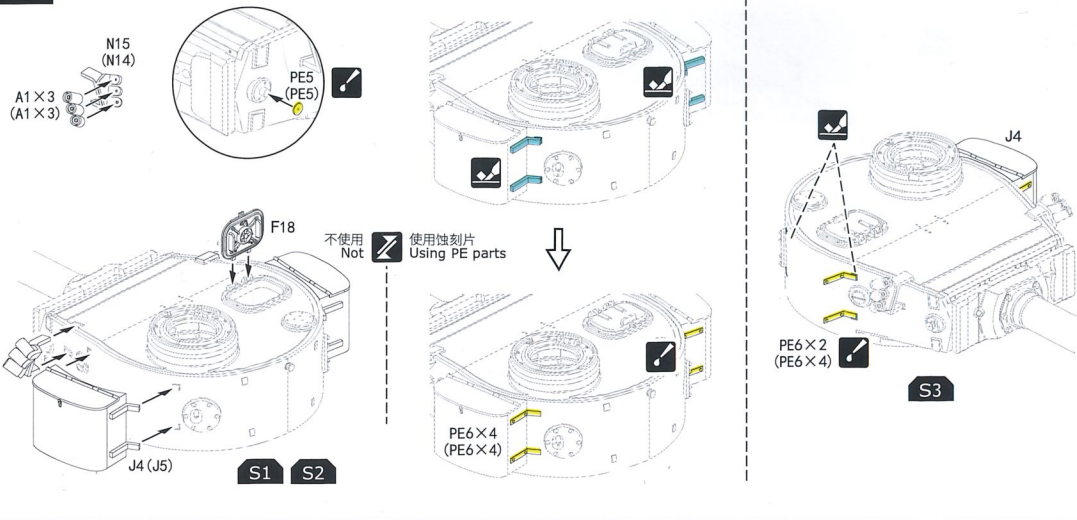

9

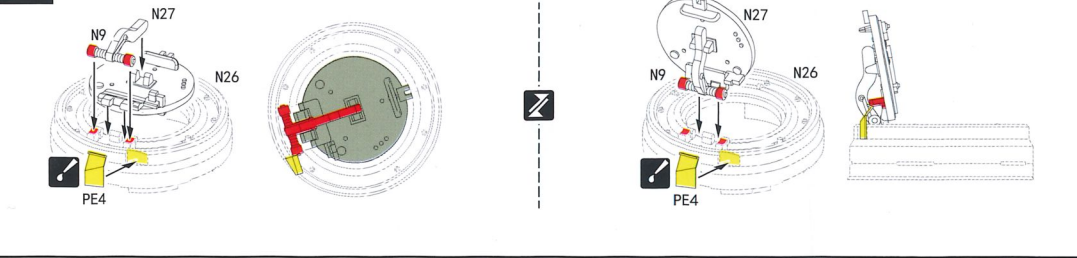

10

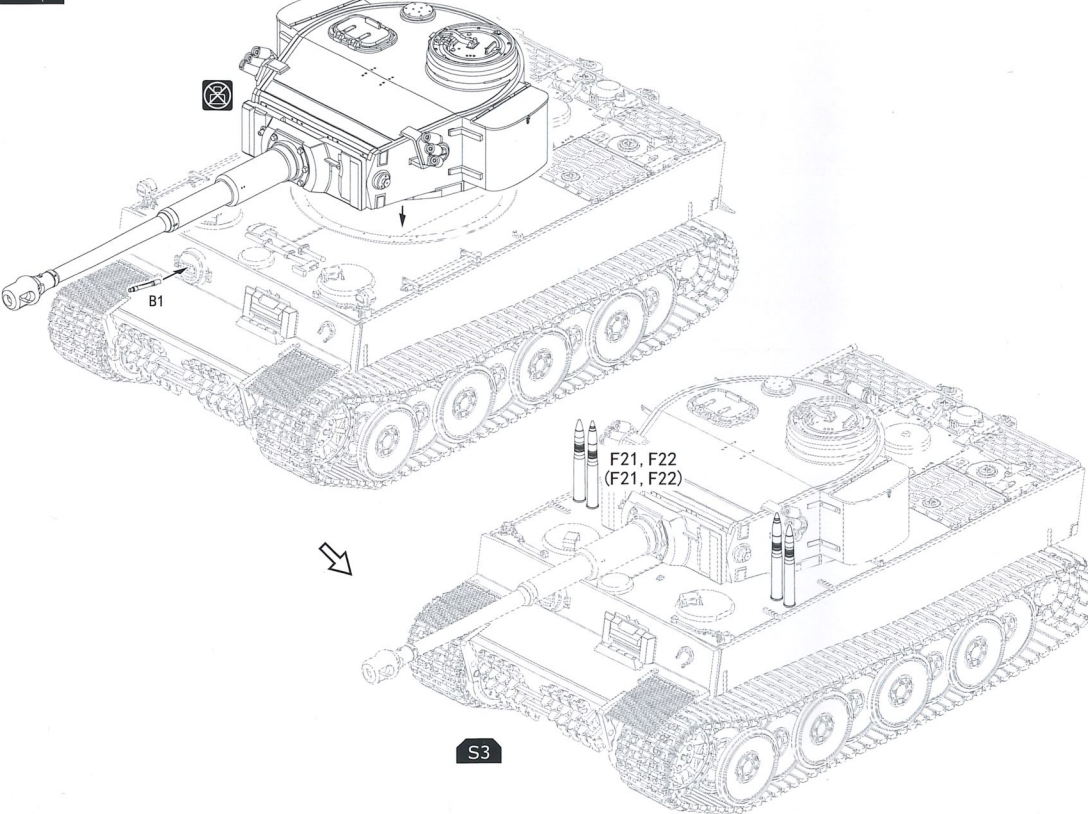

8