

AT6 OR SNJ

70

80

AURORA

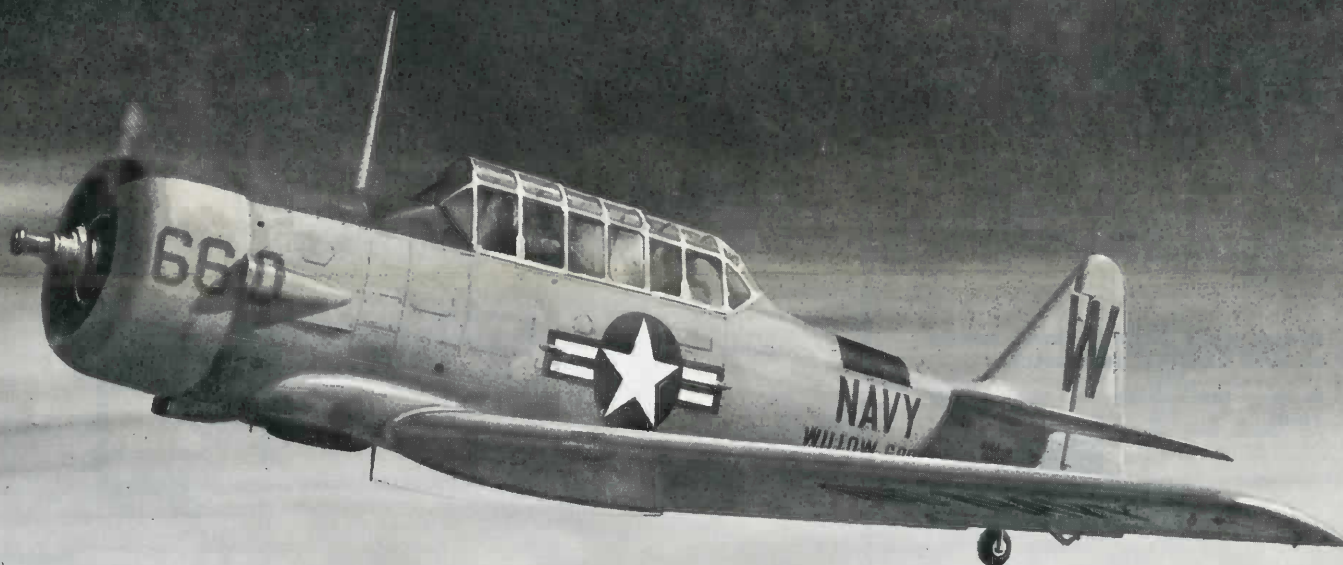

LITHO IN U. S. A.

MADE IN U. S. A.

IMPORTANT - READ THIS FIRST!

Before assembling model, study sketch carefully.

Important—Apply cement to inside surfaces only. Avoid getting cement on outer surfaces of model sections. Use cement very sparingly and avoid getting cement on hands, so as not to mar or smear plastic surfaces.

Do not hurry. Work carefully and patiently. Important Note: Before proceeding to cement parts together, it is advisable to fit parts together dry (without cement) so that you may familiarize yourself with the parts and how they go together, also noting the points where cement is to be applied.

For best results assemble model exactly in the order indicated.

This kit is molded of styrene plastic—Use only Aurora's Fireproof Styrene Cement and Aurora's Speed-Dry Enamel. Assure yourself of a perfect model every time!

MADE IN U. S. A. LITHO IN U. S. A.

© AURORA PLASTICS CORP. 1960
West Hempstead, L. I., N. Y.

FACTS ABOUT THE NORTH AMERICAN AT-6 TEXAN AND SNJ-4

The peaceful quiet of the Korean terrain belied the death lurking there in the carefully camouflaged ambushment concealing a squad of serious-faced Communist soldiers. The heavily armed hideout became suddenly alert at the sound of a distant 'buzzing' hum. The hum increased in volume as a North American T-6 Texan of the U.S.A.F. skimmed over the treetops on aerial reconnaissance and the enemy squad cursed this 'most hated mosquito' as it searched them out. The T-6 observer called the pilot's attention to a reflecting glint on the uneven ground surface. The Korean enemy watched the Texan swerve in their direction, and sent a volley of gunfire in defiant resistance. With an ear-cracking high rpm roar, the T-6 unerringly passed over the enemy hideout and dropped a smoke-bomb to mark the target. Seconds later, a pair of F-86 Sabres screamed out of the heavens in answer to the T-6 call, and spotting the smoke marker, seared over the panic stricken Communists, wiping their entrenchment from the face of the earth with machine-gun fire and ravaging rockets. After a wave to the Sabres from its pilot and observer, the T-6 continued on its hunting mission.

The sturdy North American T-6 Texan (SNJ-4, Navy) was the same to World War II as the famous Curtiss Jenny was to World War I. Reliable, dependable and versatile, the T-6 was first used by the U. S. Army Air Corps in 1936 under the designation BC-1. This particular plane was the ancestor of the highly regarded T-6, an aircraft that was flown by more pilots than any other since the birth of aviation. Undoubtedly, you will find some

T-6 time listed in the pilot's log book of some 35 Allied nations. Thousands of the T-6 were produced in the United States by North American Aviation, Inc.; Australia by the Commonwealth Aircraft Co. and by Noorduy in Canada. Various official names were AT-6, SNJ-4, Texan (U.S.A.); Wirraway (Australia); and Harvard (Britain and Canada) as well as the nickname 'Mosquito' on the Korean battlefield.

Over 5,000 SNJs were used by the Navy in six variations. The SNJ-4s were built as Army AT-6Cs. All Texans built, Navy and Army, were procured under Army contracts. In addition to war time roles as fighter, aerial spotter, trainer, and even bomber — the Texan was used as an advanced trainer for the fighting pilots of dozens of Allied nations and as Utility and Flag Units of the U. S. Navy. Universally accepted, North American produced some 20,000 T-6s for war service. Specifications of 1952 list wing span as 42', length 29'. Power plant — Pratt & Whitney R1340-AN-1, speed — 200 mph range.

Old soldiers (and airplanes) never die, they just fade away does not apply to the amazing Texan. After a commendable war time service, the U.S.A.F. retained the Texan in modified form as a T-6G standard trainer. Progressive development of the Texan led to the T-28 advanced trainer prototype which first flew September 26, 1949. In 1952 the T-28 was adopted as the National standard trainer of all American Air Forces.

The TEXAN, or HARVARD, or WIRRAWAY, or MOSQUITO lives on in the memories of many unsung heroes of the Second World War era, whether they are Canadian, American, British, Aussie, Mexican, Brazilian, etc. The North American AT-6 Texan well deserves a niche in the time honored roll call of aircraft serving the cause of humanity.

AT6 OR SNJ

FOR SUGGESTED DETAIL PAINTING SCHEME—see ILLUSTRATIONS. Paint parts as indicated and allow to dry before assembling.

For best results, USE ONLY AURORA'S SPEED-DRY ENAMEL—DRIES IN 30 MINUTES—ONE COAT COVERS—NO BRUSH MARKS.

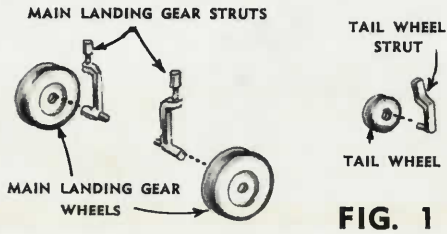

FIG. 1

1. Cement MAIN LANDING GEAR WHEELS to MAIN LANDING GEAR STRUTS.
2. Cement TAIL WHEEL to TAIL WHEEL STRUT.

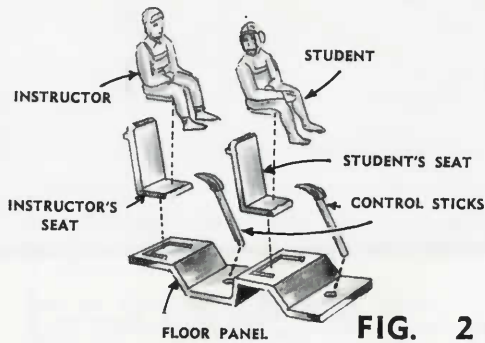

FIG. 2

3. Cement STUDENT'S and INSTRUCTOR'S SEATS to FLOOR PANEL.
4. Cement STUDENT and INSTRUCTOR PILOTS to SEATS.
5. Cement CONTROL STICKS to FLOOR PANEL.

THIS KIT IS MOLDED OF STYRENE PLASTIC

Use Only . . .

AURORA'S

FIREPROOF
STYRENE PLASTIC
CEMENT

TUBE 10c
BOTTLE WITH BRUSH 25c

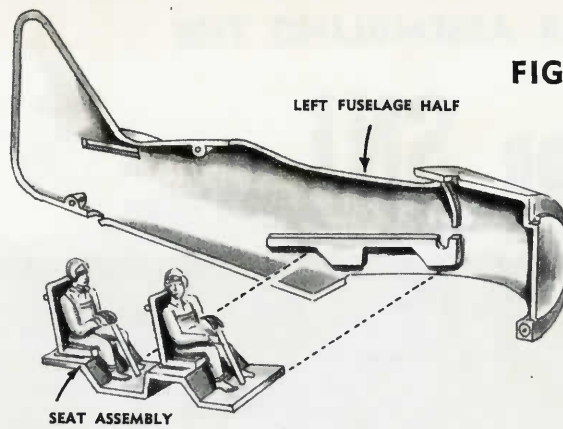
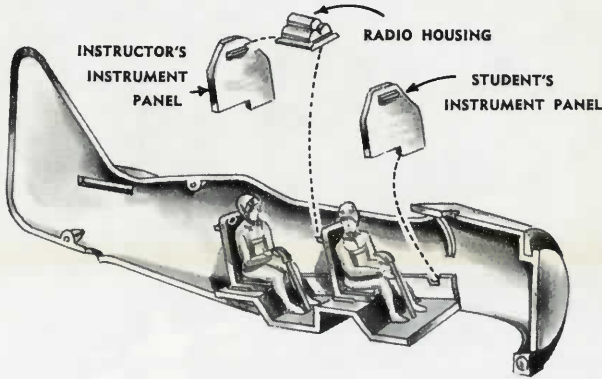
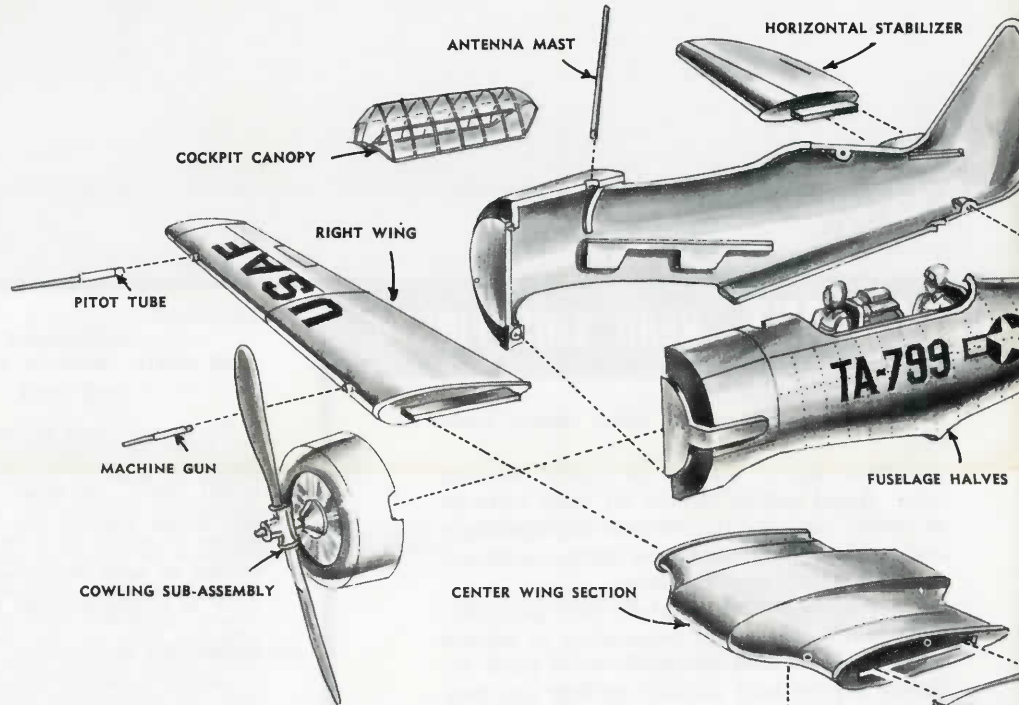

FIG. 3



6. Cement FLOOR PANEL and SEAT BLY to LEFT FUSELAGE HALF.
7. Cement STUDENT'S INSTRUMENT to LEFT FUSELAGE HALF.
8. Cement RADIO HOUSING to back DENT'S SEAT.
9. Cement INSTRUCTOR'S INSTRUMENT EL to back of RADIO HOUSING.



16. Cement FUSELAGE HALVES together.
17. Cement CENTER WING SECTION to FUSELAGE.
18. Cement LEFT and RIGHT WINGS to CENTER WING section.
19. Cement HORIZONTAL STABILIZERS to FUSELAGE.
20. Cement PROPELLER and COWLING sub-assembly to FUSELAGE.

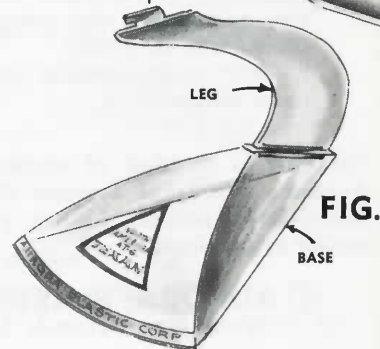
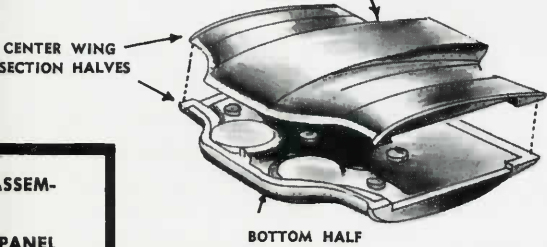
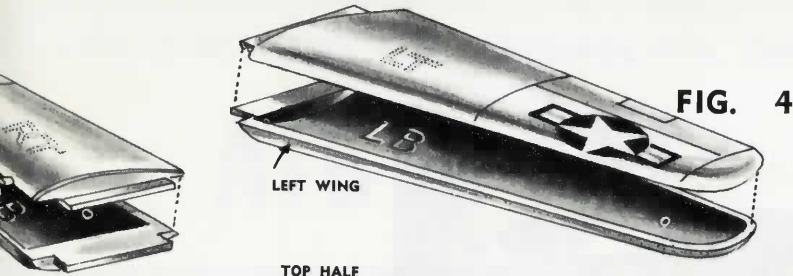

FIG.



10. Cement TOP and BOTTOM HALVES of LEFT WING together (LT to LB).
11. Cement TOP and BOTTOM HALVES of RIGHT WING together (RT to RB). Set aside to dry.
12. Cement TOP and BOTTOM HALVES of CENTER WING together.

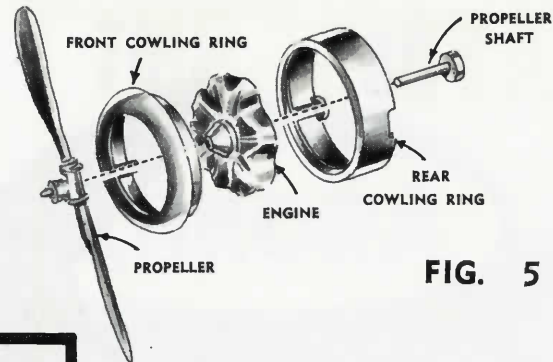

FIG. 5

13. Cement ENGINE to FRONT COWLING RING.
14. Cement REAR COWLING RING to FRONT COWLING RING, being careful to align etched areas on RINGS. Allow to dry.
15. Insert PROPELLER SHAFT through hole in ENGINE and cement Propeller to Propeller Shaft.

Note — Be careful not to get any cement between propeller and cowling.

ASSEM-
PANEL
STU-
PAN-



1. Cut each decalcomia from sheet separately inside of cutting lines close to design.
2. Dip each decalcomia into water for approximately 30 seconds, and then lay on flat surface.
3. When decalcomia slides easily on paper backing, DON'T FORCE! with most fingers slide decalcomia partly off paper and place on location desired. Hold decalcomia in this position and then slide paper backing from underneath design. (Note illustration.)
4. Press out bubbles with soft, damp cloth and allow decalcomia to set.

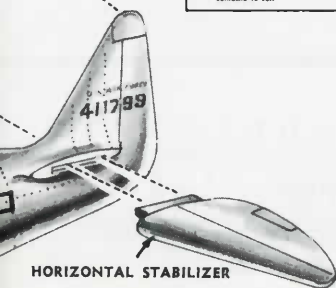

HORIZONTAL STABILIZER

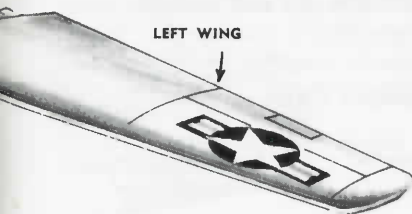

LEFT WING

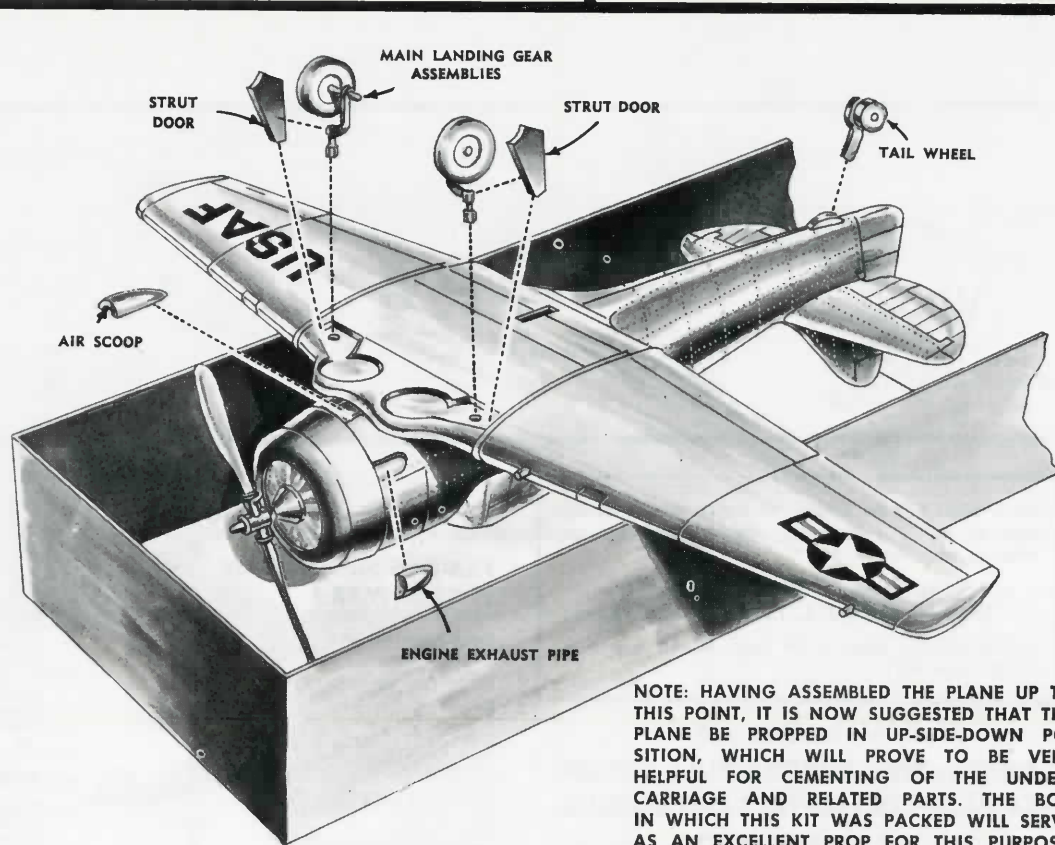

FIG. 7

NOTE: HAVING ASSEMBLED THE PLANE UP TO THIS POINT, IT IS NOW SUGGESTED THAT THE PLANE BE PROPPED IN UP-SIDE-DOWN POSITION, WHICH WILL PROVE TO BE VERY HELPFUL FOR CEMENTING OF THE UNDERCARRIAGE AND RELATED PARTS. THE BOX IN WHICH THIS KIT WAS PACKED WILL SERVE AS AN EXCELLENT PROP FOR THIS PURPOSE.

21. Cement MAIN LANDING GEAR to underside of FUSELAGE.
22. Cement STRUT doors to underside of FUSELAGE.
23. Cement ENGINE EXHAUST PIPE to RIGHT SIDE of FUSELAGE.
24. Cement AIR SCOOP to underside of FUSELAGE. (See Fig. 6.)
25. Cement ANTENNA MAST, PITOT TUBE and MACHINE GUN to PLANE as indicated in sketch.
26. Cement COCKPIT CANOPY over COCKPIT.
27. Insert LEG of STAND into slot in BASE and mount MODEL on STAND.
28. Cut out sections of DECALS to correspond with markings on PLANE. Read directions on back of DECALS before applying.

"THE ENAMEL WITH THE SPRAYED ON LOOK"

- ONE COAT COVERS
- NO BRUSH MARKS
- DRIES IN 30 MINUTES



SPEED-DRY ENAMELS are AURORA'S REVOLUTIONARY NEW ENAMEL PAINTS developed after years of research especially for Plastic Models and other products of Wood, Metal, Glass or China.

Detail Painting Instructions

- Black: Tires
Engine Cylinders and Exhausts
Propeller Blades
Instrument Panels
Wing Wells
Anti-Glare Panels on Fuselage and Cowling
Radio Housing
Radio Housing
Instrument Dial Faces
Brown: Pilot's Flying Suit and Helmet
Flesh: Pilot's Face
Yellow: Propeller Tips



DECAL LAYOUT FOR SNJ

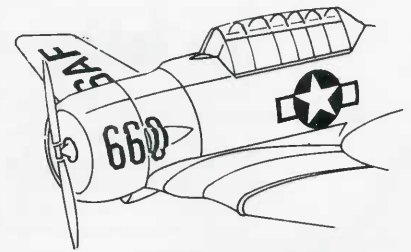
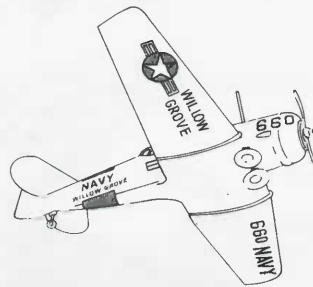
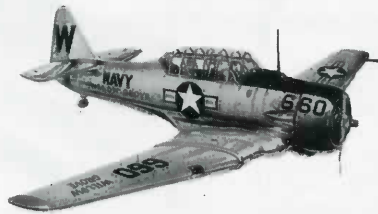

Every effort has been made to insure the completeness of this Kit—however, should any part be missing, write directly to:

AURORA PLASTICS CORP.
West Hempstead, L. I., N. Y., Dept. M

(When writing please print your NAME and ADDRESS PLAINLY)

Mail this coupon and 25c
for your New AURORA FULL COLOR
44 PAGE COLLECTOR'S CATALOGUE
OF HOBBY KITS

AURORA PLASTICS CORP. DEPT. C
44 Cherry Valley Rd., W. Hempstead, New York

Please rush me by return mail the new 44 page full-color AURORA HOBBY KIT CATALOGUE. I am enclosing 25c in stamps or coin.

NAME (PLEASE PRINT)

ADDRESS

CITY ZONE

STATE

CONTENTS: MERCHANDISE—Postmaster: This parcel may be opened for postal inspection. Return postage guaranteed.

Cut Along Line

A FEW OF AURORA'S SCALE MODEL KITS

FAMOUS FIGHTERS OF WORLD WAR I

- DeHaviland Tiger Moth
- French Nieuport
- Sopwith Camel
- British Scout SE-5
- German Albatross D-3
- Fokker DR-1 Triplane
- Fokker D-7
- Spad 13
- Nieuport 28
- Pfalz D-3
- DeHaviland DH-4
- F2B "Brisfit"
- JN-4 "Jenny"
- DeHaviland DH-10 Bomber
- Gotha Bomber



FAMOUS FIGHTERS OF WORLD WAR II

- P-38 Lockheed Lightning
- P-51 Mustang
- Curtiss P-40
- Hellcat
- AT-6 Texan
- SNJ Navy Trainer
- B-17 Flying Fortress
- British Spitfire
- ME-109 Messerschmitt
- Japanese Zero
- Russian Mig-19
- Focke-Wulf

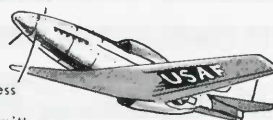

GIANT BOMBERS

- B-26 Martin "Marauder"
- B-29 Superfortress
- B-25 Mitchell Bomber
- PBY "Catalina"
- B-58 Hustler
- Russian Nuclear Bomber

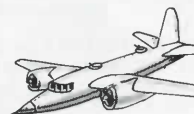

FAMOUS WARSHIPS

- Pocket Battleship Graf Spee
- Battleship U.S.S. Iowa
- Destroyer U.S.S. Halford
- Carrier U.S.S. Saratoga
- Destroyer U.S.S. Bennion
- Cruiser U.S.S. St. Paul
- Carrier U.S.S. Forrestal
- Submarine U.S.S. Sea Wolf
- Atomic Submarine S.S.N. Nautilus
- "Q" Ship Atlantis—German Raider



FAMOUS SAILING SHIPS

- Pirate Ship Black Falcon
- Chinese Junk
- Viking Ship
- Blue Nose Schooner
- Cutty Sark
- Corsair



SUPER MODERN JET AIR LINERS

- Pan American Boeing 707
- TWA Boeing 707
- TU104 Russian Jet



RACING SPORT CARS

- The MG
- The Jaguar
- Ferrari 342 "America"
- Ferrari Sportster
- The Cunningham

