

SIAI Marchetti SF 260TP

SIAI-Marchetti SF.260 je lehký italský letoun, který je na trh dodáván jako vojenský stroj a nebo v civilní akrobatické variantě.

SF.260 je dílem italského konstruktéra Stelio Frathi. výroba typu zpočátku probíhala u firmy Aviamilano v Miláně. První let prototypu tehdy značeného jako F 260 proběhl 15 července 1964. Velmi záhy byla práva k výrobě typu odkoupena společností SIAI Marchetti a výroba probíhala až do roku 1997, kdy celou firmu převzal další italský výrobce Aermacchi.

Letoun se prodával ve velkých počtech vojenským zákazníkům jako cvičný a lehký bojový. Mimo vojenské zakázky probíhaly i prodeje soukromým subjektům z civilního sektoru a to od konce šedesátých let. Ve Spojených státech se stroj prodával pod obchodním názvem Waco Meteor.

Vojenská ozbrojená verze, označovaná jako SF 260W Warrior byla velmi oblíbená především u menších vojenských letectev, pro které představoval letoun snadnou a úspěšnou možnost řešení úkolů přímé letecké podpory.

Vyráběny byly verze s klasickým pístovým motorem i varianta s turbovrtulovým pohonem označená SF 260TP s motorem Allison 250-B17D, která poprvé letěla v roce 1980.

TECHNICKÁ DATA:/TECHNICAL DATA:

Délka/Length:	7,1 m
Rozpětí/Wing span:	8,35 m
Výška/Height:	2,41 m
Nosná plocha/Wing area:	10,10 m ²
Hmotnost prázdná/Empty weight:	755 kg
Vzletová hmotnost/Take-off weight:	1,200 kg
Motor/Powerplant:	1 × Allison 250-B17D
Max. rychlost/Max. speed:	333 km/h
Dolet/Range:	1,650 km
Dostup/Service ceiling:	4,665 m
Výzbroj/Armament:	různé varianty na podvěsech/various on pods

REFERENCES USED/POUŽITÉ PODKLADY:

SIAI SF 260 in Belgium
Factory plans
Advertisement materials
internet
personal files/osobní sbírky

The SIAI-Marchetti SF.260 is an Italian light aircraft which has been commonly marketed as a military trainer and aerobatics aircraft.

The SF.260 was designed by Italian aircraft designer Stelio Frati, while production work originally performed by Milan-based aviation manufacturer Aviamilano. On 15 July 1964, the first prototype performed its maiden flight (then designated F.260). Shortly thereafter, responsibility for production was transferred to SIAI Marchetti, who had purchased the rights to the design; manufacturing continued to be performed by this firm until the company was bought by Aermacchi in 1997.

The SF.260 has been largely sold to military customers as a trainer and light combat aircraft. In addition, there have been limited civil sales to private operators; during the late 1960s, the type was marketed in the United States under the name Waco Meteor. Armed military versions, sold as the SF.260W Warrior, proved to be popular with smaller air forces, which could arm the type for use in the close air support role. Both piston-powered and turboprop-powered models have been developed, the latter designated as SF 260TP equipped with Allison 250-B17D engine.

Navštivte náš e-shop
<https://eshop.kovozavody.cz/>
Visit our e-shop



OPTIONAL
VOLITELNÉ



DRILL HOLE
VYVRTAT



SYMMETRICAL
SYMETRICKY



REMOVE
ODSTRANIT

Plastové díly/Plastic parts

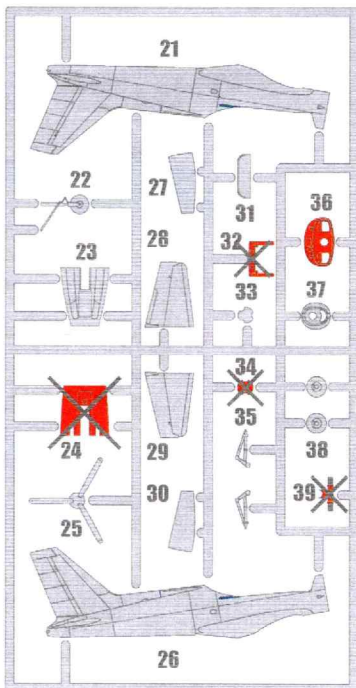
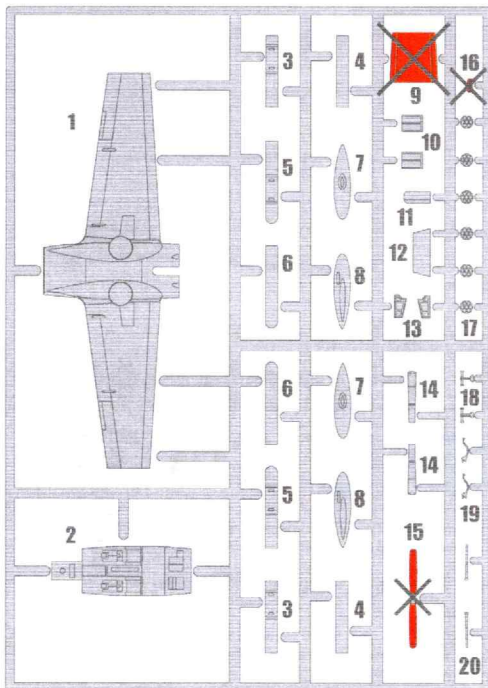

Průhledný díl/
Clear part

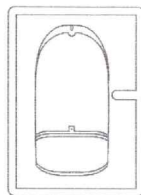

CPI

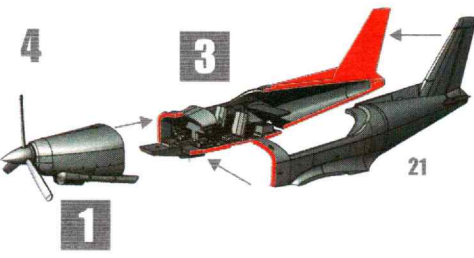
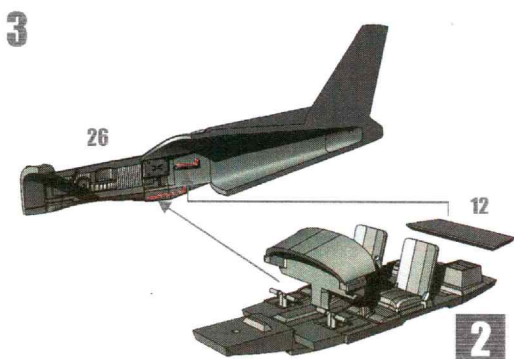
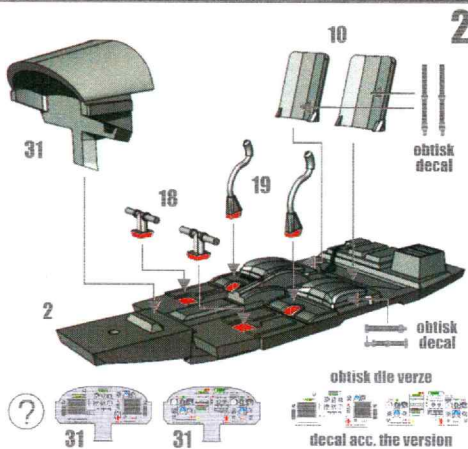

Stavební kroky 5 až 8 jsou shodné pro SF 260 i SF 260TP
 Building steps 5 to 8 are the same for SF 260 and SF 260TP

5

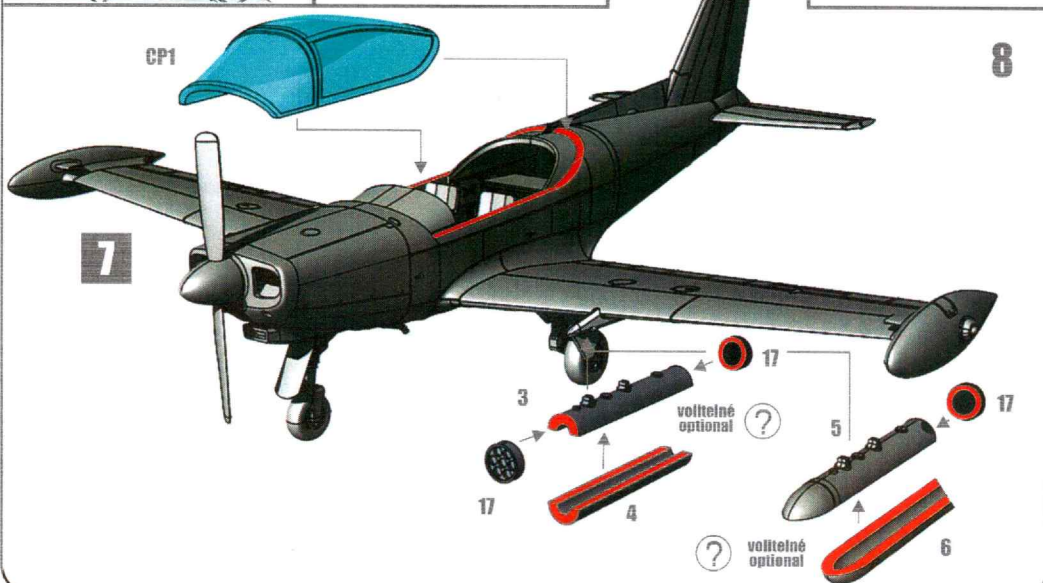
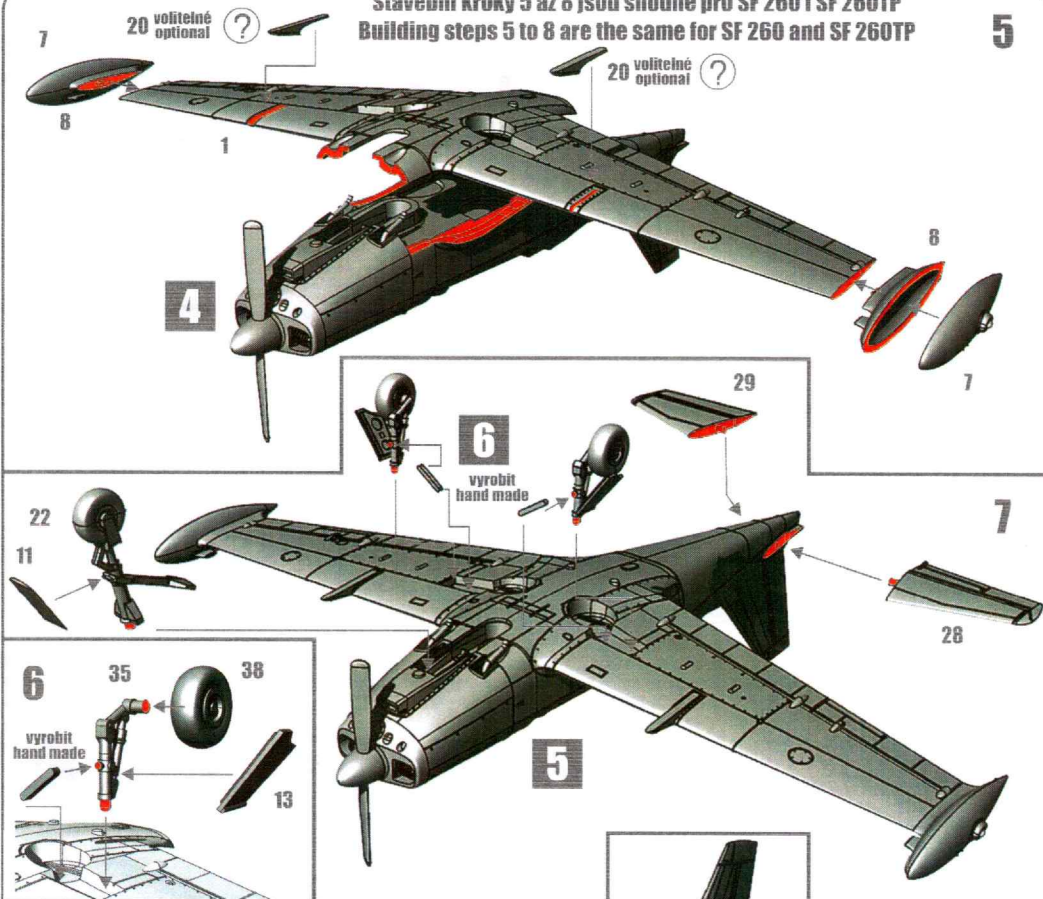

20 voliteľné optional

20 voliteľné optional

6 vyrobiť hand made

6 vyrobiť hand made

voliteľné optional

voliteľné optional

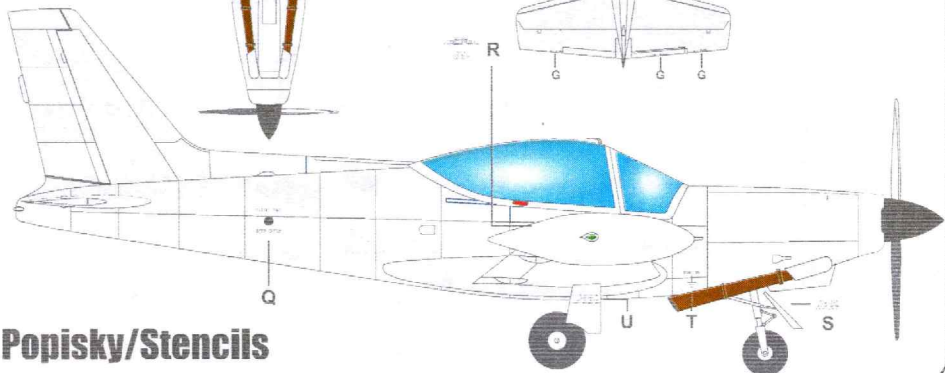
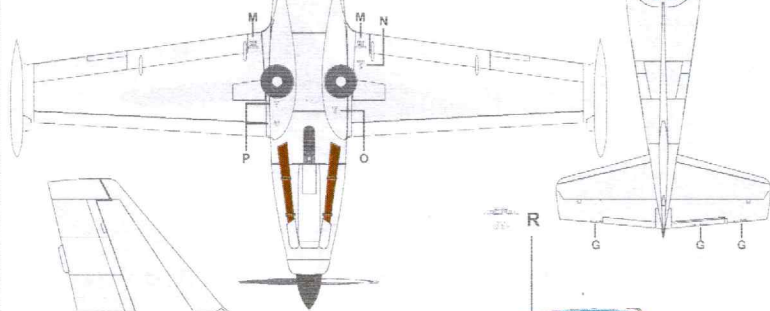
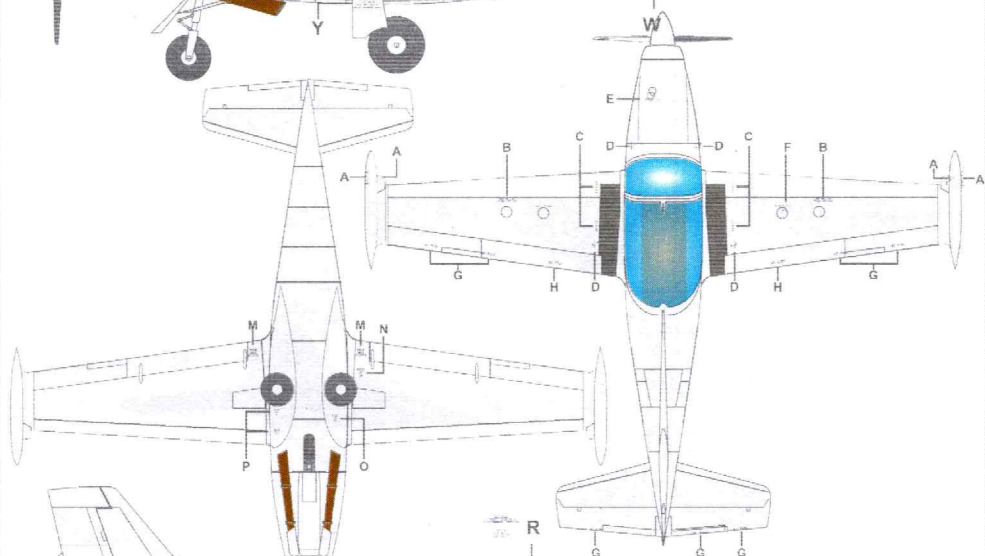
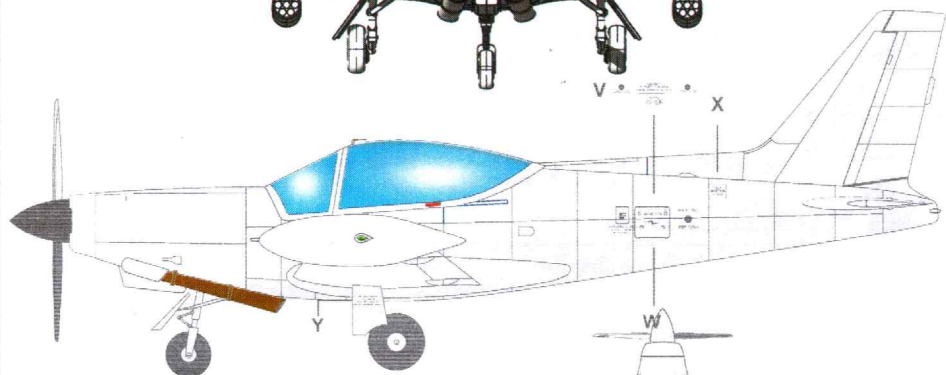
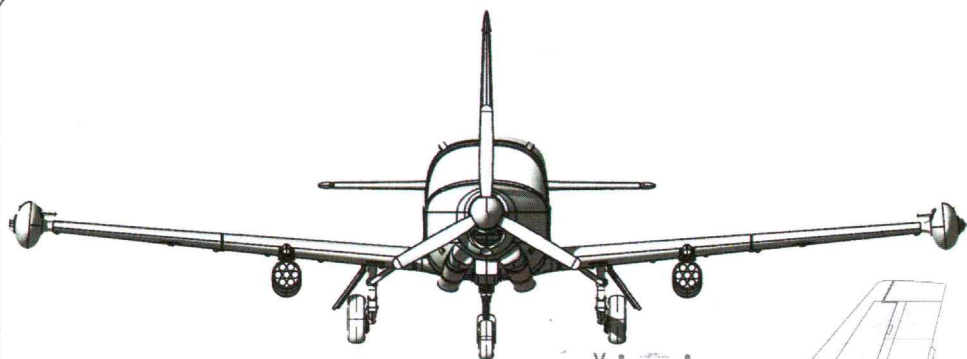

Popisky/Stencils

Z NOVÝCH FOREM / NEW TOOL MODEL



KOVOŽÁVODY

PROSTĚJOV



CARLOS
ALONSO
2020

1/72

SIAI **SF-260TP** "Light Attacker"

Zbarvení & Označení Colours & Markings

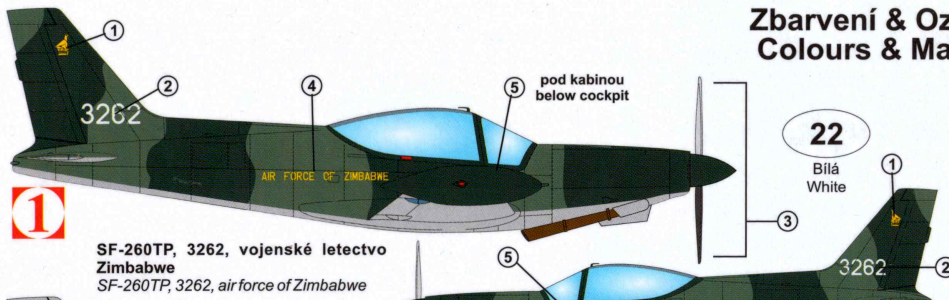

**SF-260TP, 3262, vojenské letectvo
Zimbabwe**
SF-260TP, 3262, air force of Zimbabwe

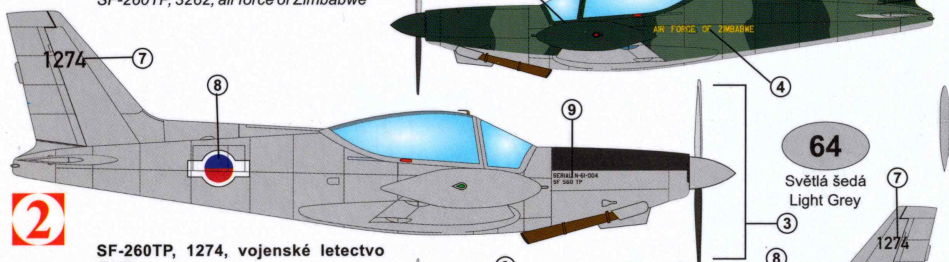

**SF-260TP, 1274, vojenské letectvo
Haiti**
SF-260TP, 1274, Haitian Air Force

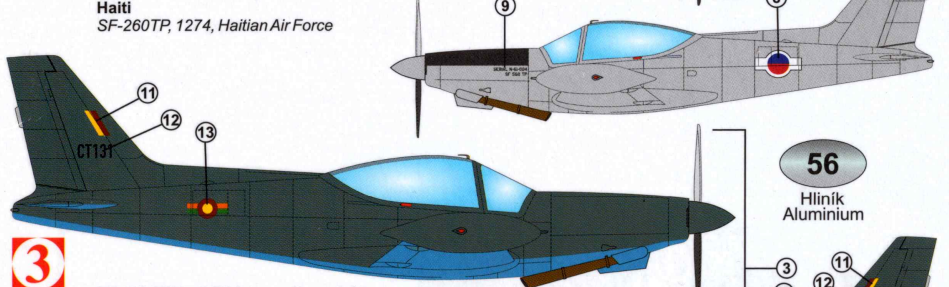

**SF-260TP, CT131, srilanského
vojenského letectva**
SF-260TP, CT131, Sri Lankan Air Force

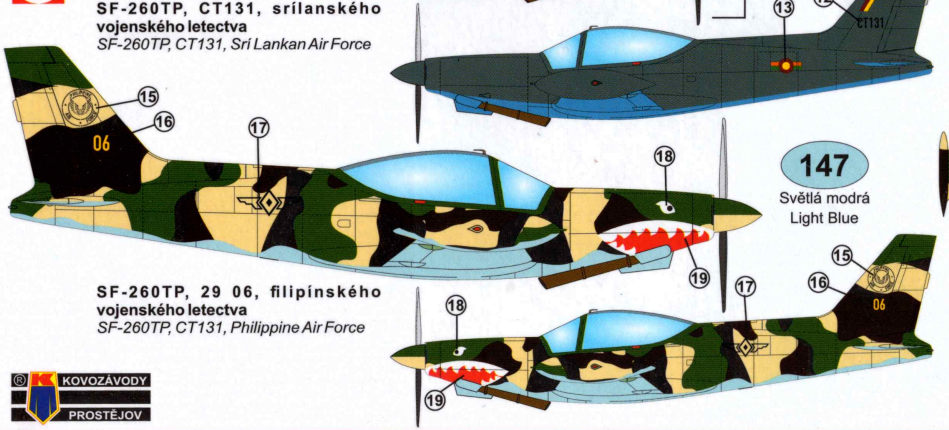

**SF-260TP, 29 06, filipinského
vojenského letectva**
SF-260TP, CT131, Philippine Air Force

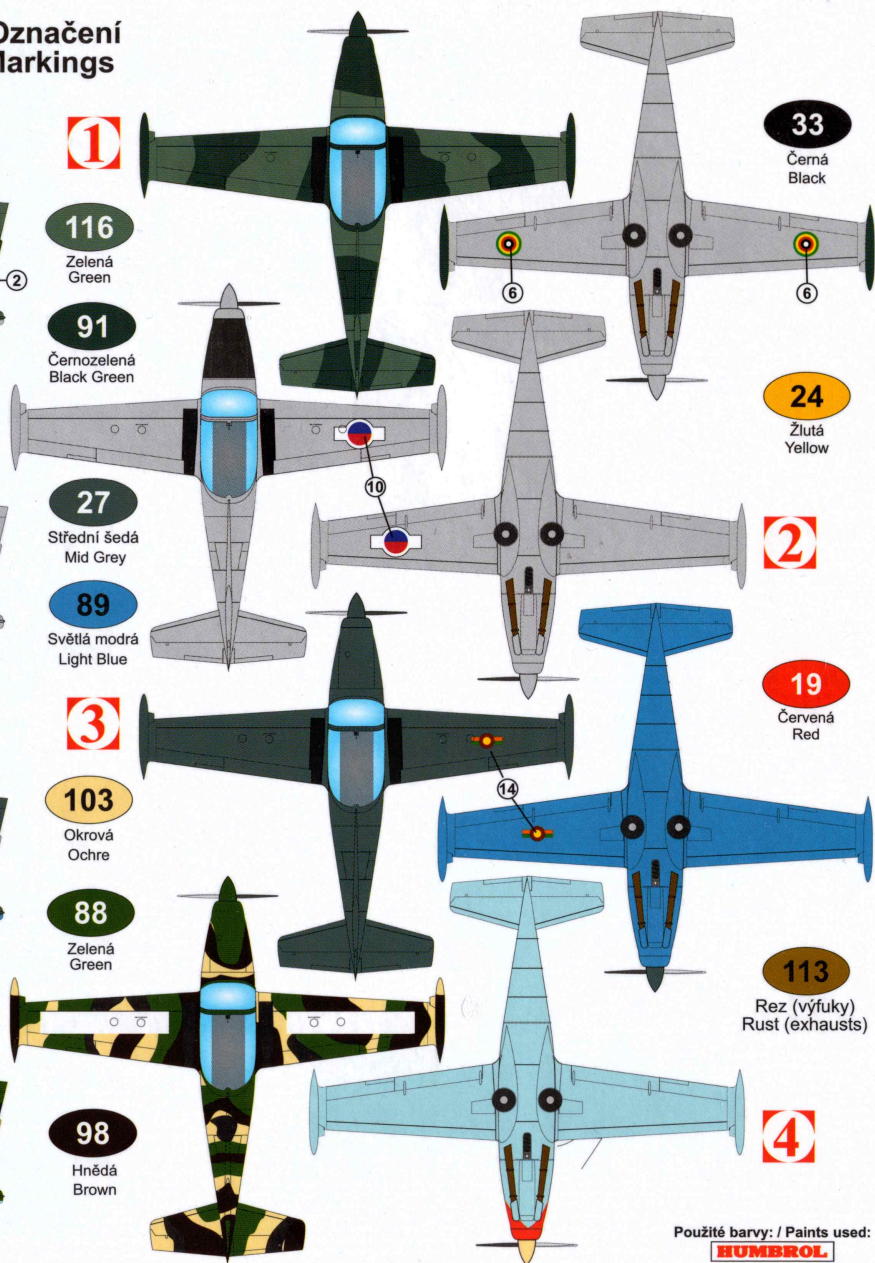

3282 3262

AIR FORCE OF ZIMBABWE

AIR FORCE OF ZIMBABWE



CT131



4
19



1

19



CT131

12



14



13



6



18

3



SERIAL N-61-004
SF 260 TP

29 06 1274



17

29 06 1274

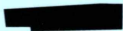

NO PUSH NO PUSH NO PUSH NO PUSH NO PUSH NO STEP NO STEP

H E

A

Q

X

T

L

Y

U J U

M R

D

S

C

N

F

KPM 0214 SF 260TP „Light Attacker”