

? 選擇 (Select)

T 鑽孔 (Make hole)

填充部分切除 (Cut the Shadow)

○ 蝕刻零件號 (PE Part No.)

水貼紙 (Decals)

折彎 (Sharp Bend)

卷曲 (Ro11)

替換原零件 (Replace Original Part)

另一側相同制作 (Same another side)

原零件號 (Original Part No.)

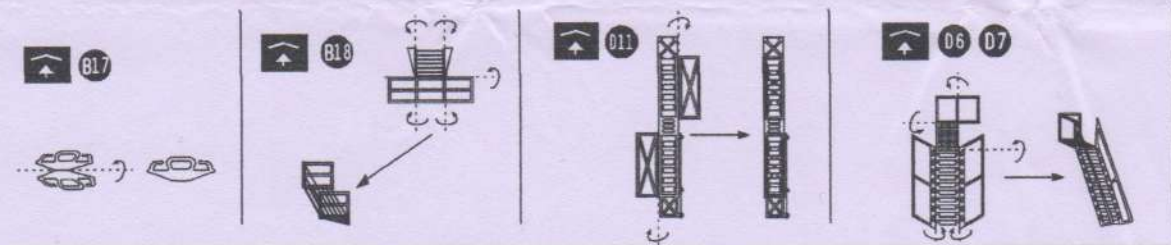
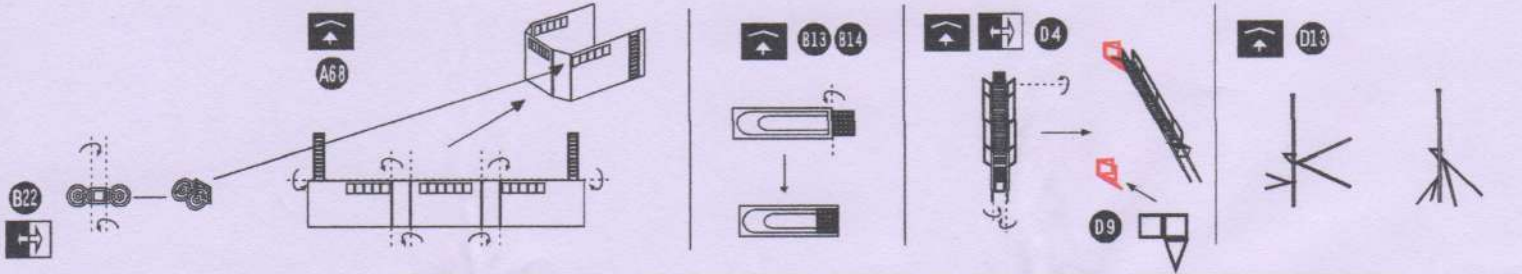
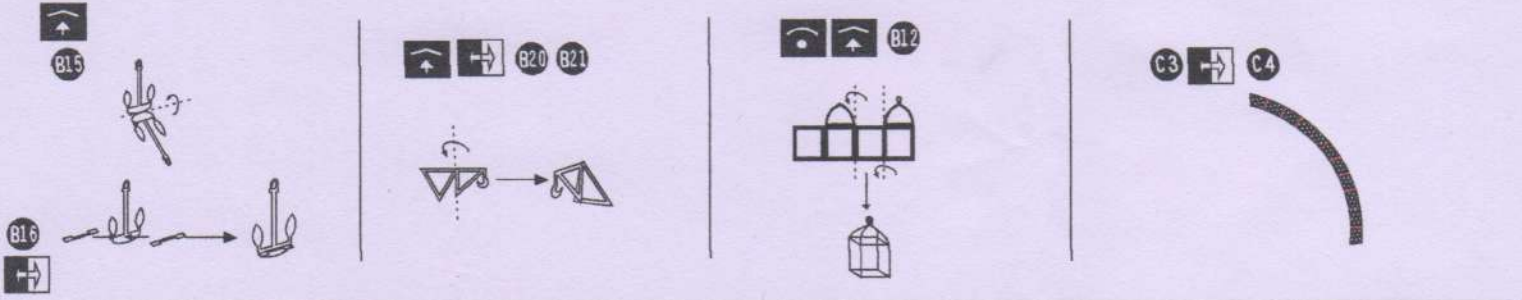

胶棒  
Glue Stick  
长度 Length 10.5mm  
直径 Diameter 0.8mm

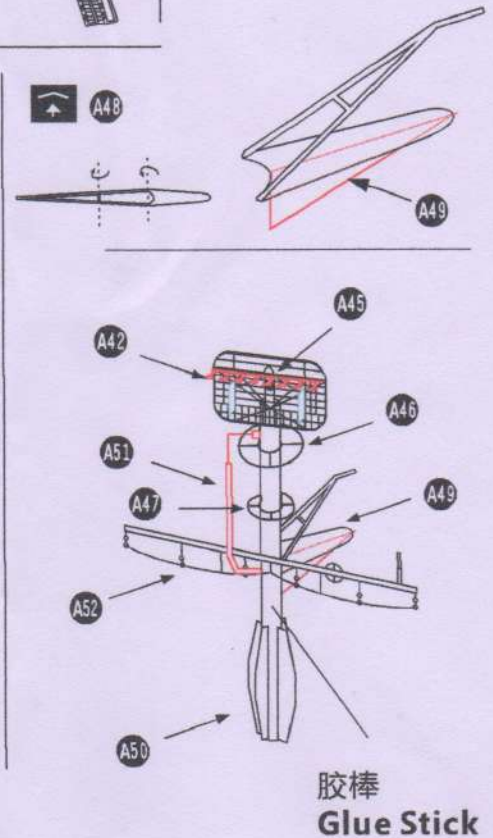
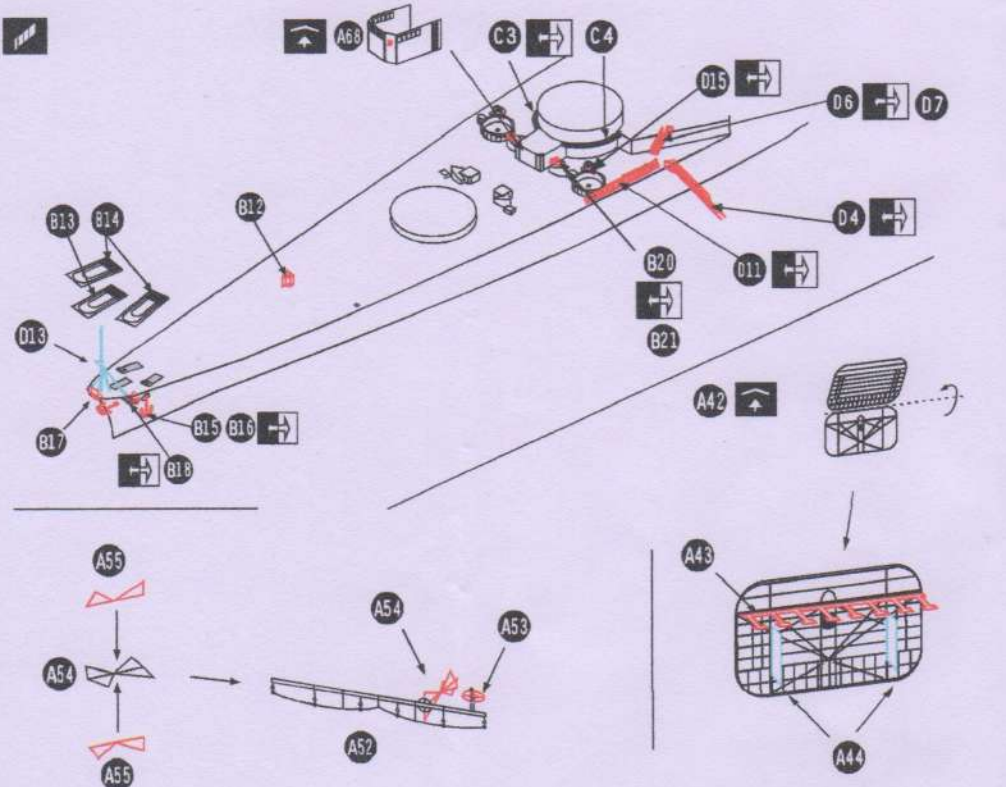

胶棒  
Glue Stick

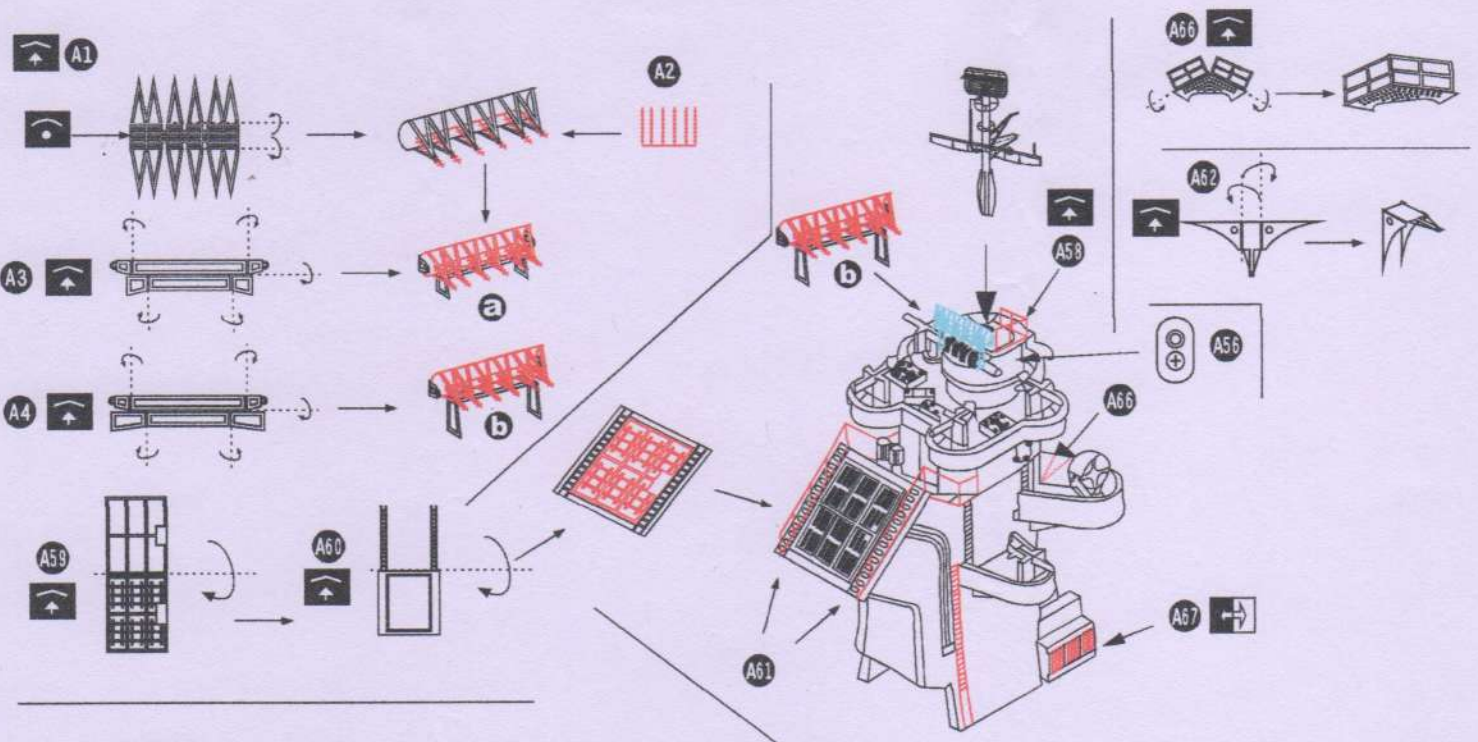

H33

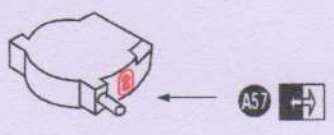

# Back

