

# FinMilModels

## Sisu A-45 "Proto"

Instruction for scale 1/72 Sisu A-45 light off-road truck. A-45 is informally called *Proto*. The name is derived from the Finnish word "prototyppi" (prototype). This truck was made by Sisu 1970-1982. This vehicle was used on peacekeeping operations, by The Finnish Defence Forces and VR (Finnish State Railways) as recovering vehicle. A45 was also used as fire engine/truck

I would like to thank Sisu, Martti Tikka, The Finnish Defence Forces and Mil-safarit oy who made this possible.

To build this kit, you need a hobby knife, sandpapers, glue. There are 3 different sprues. Sprues are not marked because there are not that many parts.

With decals you can model few different type of versions as The Finnish Defence Forces, Mil-safarit, UN (several numbers)

Thank for choosing our product.  
**Please be careful when you cut parts!**



Page 2

Best way to start this model is start from engine. Notice, that front of the lower part of engine is under the frame. Parts as exhaust manifold you can use ONLY if you make diorama of engine service. When you use truck platform, because on material thickness there is not enough place for exhaust manifold parts. Here are also pictures for gasoline tank, air tank and for gearbox.

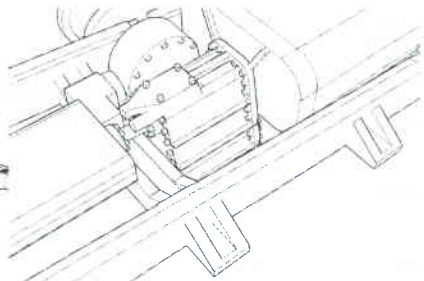
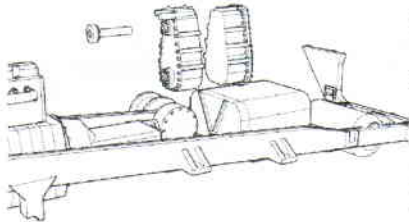
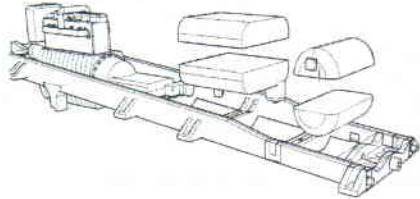
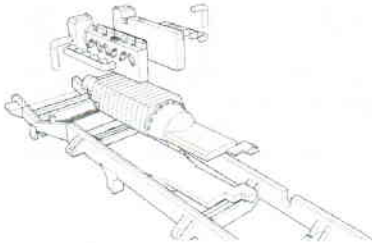

Next you can add end, hook, winch, boxes and spare tire.

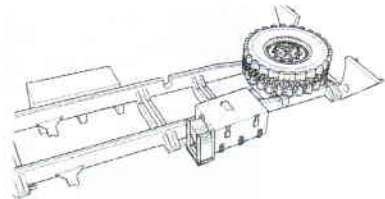
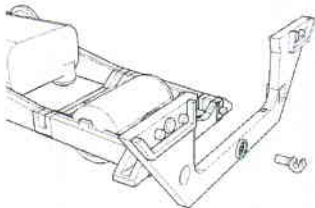
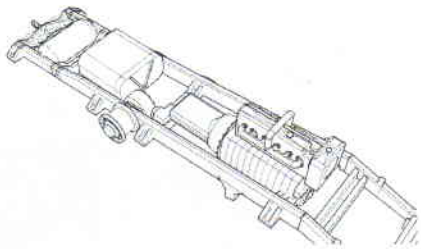
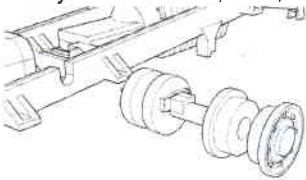

Notice, that hook and detailing part for winch (at end) are on end part.

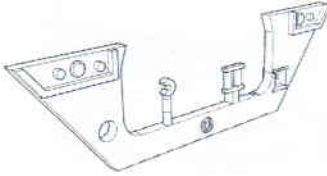

Next you need to add cabin floor, bench, back wall and doors. Notice, that back wall is vertically

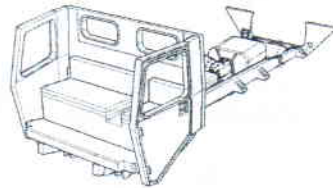
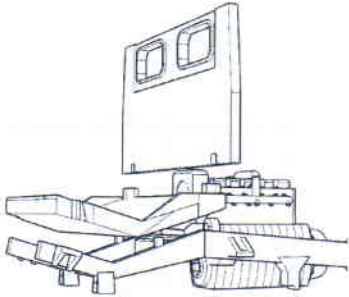

Add front of the A-45, dashboard and steering wheel. Also after you add windows, you can glue roof and bumper

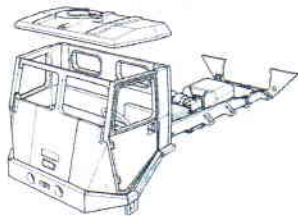
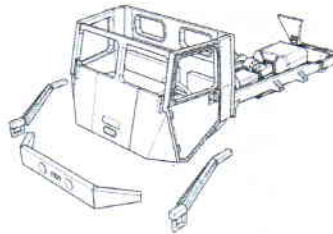
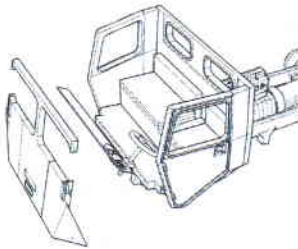

Page 4

Now you need to glue springs

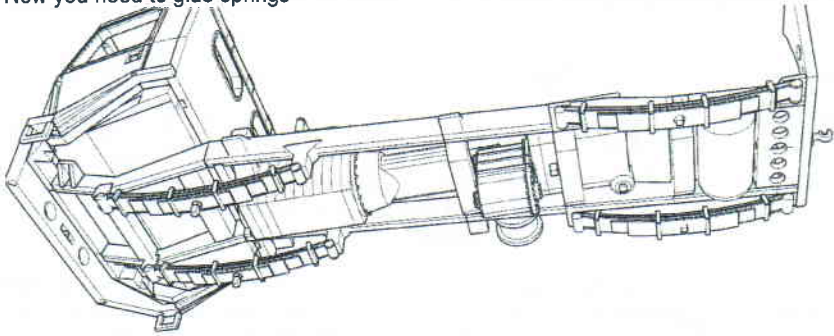

Now you need to build axles. Glue parts together and then cut axles and glue together like on picture. While doing it, measure it with springs. Shorter one is front axle

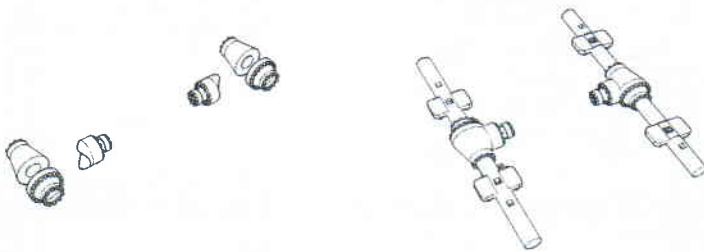

Now you can glue shock absorbers to front and all four breaks

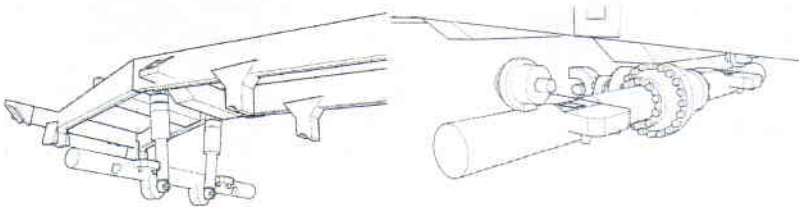

Now you can glue cardan shafts

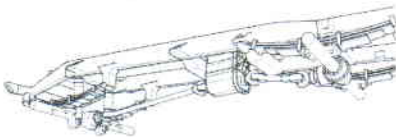

Page 5

Next is truck platform, platform supportin parts, bumper details, front axle protection and exhaust pipe.

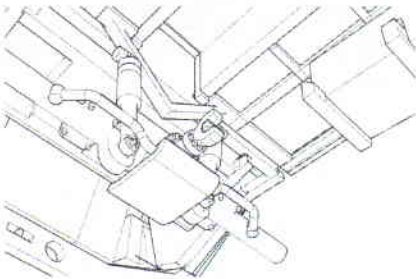
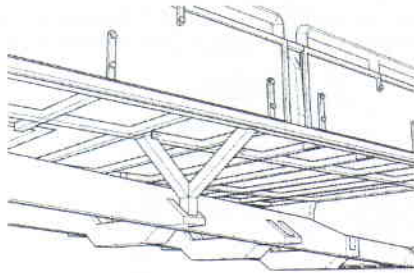
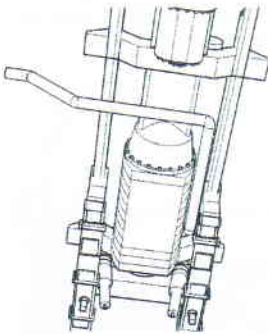
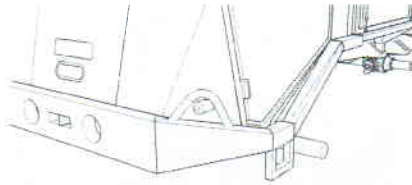
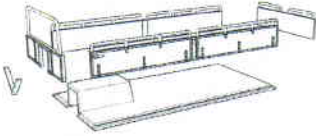

And now wheels and mirrows and your model is ready for painting



If you like to build a model with tarpaulin, you need to cut off handrails

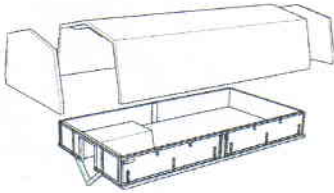

Paint for UN models is white, A-45 for VR (Finnish State Railways) is yellow. The Finnish Defence Forces has three colors. It looks there has been several different camo but here is one and when you write on google Sisu A-45 there are a lot of images.

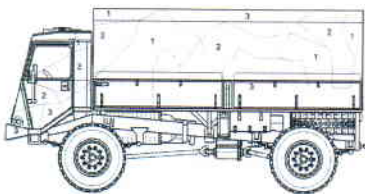
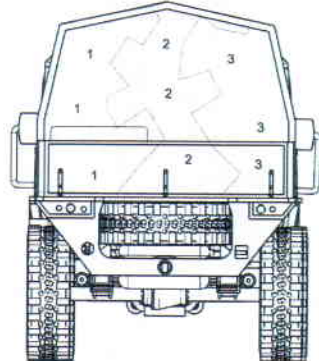
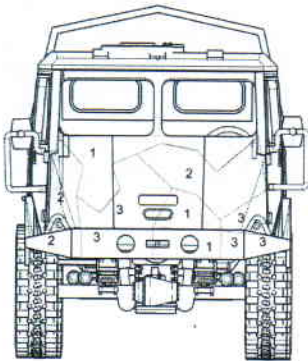

Decals set 1, 2, 3, 4 (numbers 1637, 636, 1347, 1337).  
You can use red or blue Sisu sign

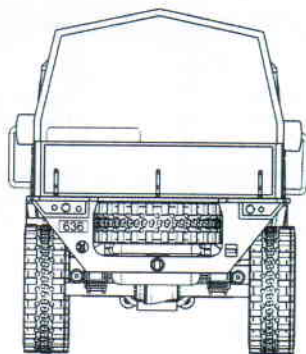
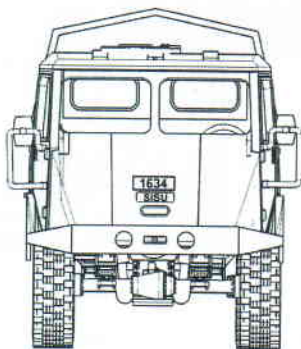



Decals for UN. UNIFIL-2732/2718 and decals for UNIFIL-3180, 3172, 3156 and 3160. You can see numbers on decal sheets

