

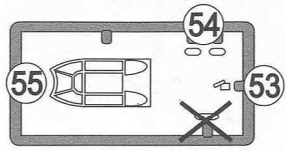

North American MUSTANG I

- | | | | |
|-----------------------|------------------------|---------------------------|----------------------------|
| 1 černá/black | 4 interior green | 7 stříbrná/silver | 10 červená-red |
| 2 kovová/gunmetal | 5 olivová /olive green | 8 opálený kov/burn metal | 11 tmavá šedá/dark grey |
| 3 zink-chromat primer | 6 kůže/leather | 9 světle šedá/ light grey | 12 tmavé plátno/dark linen |

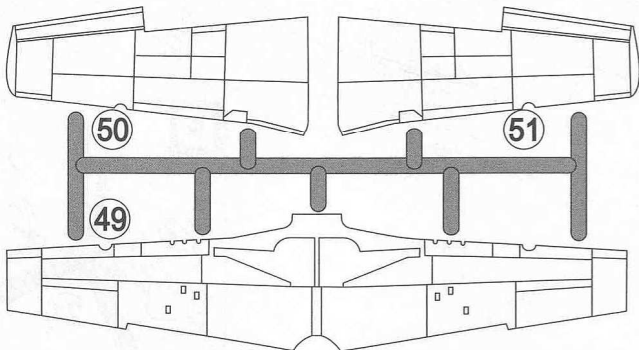
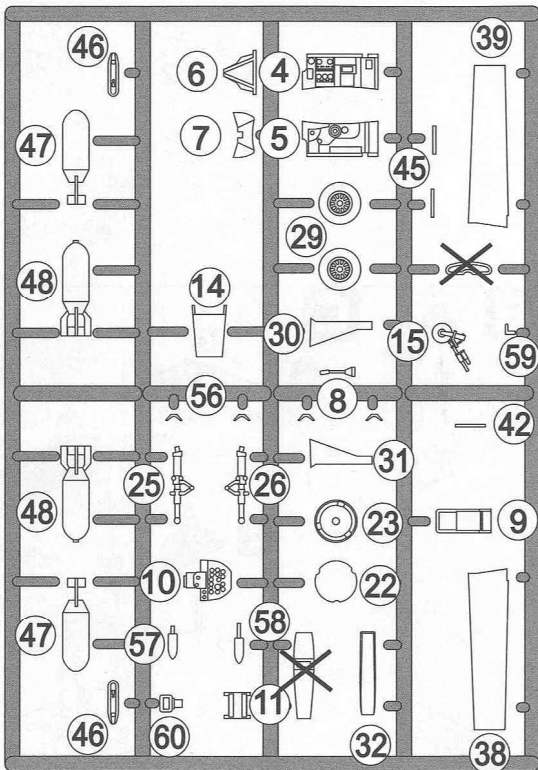
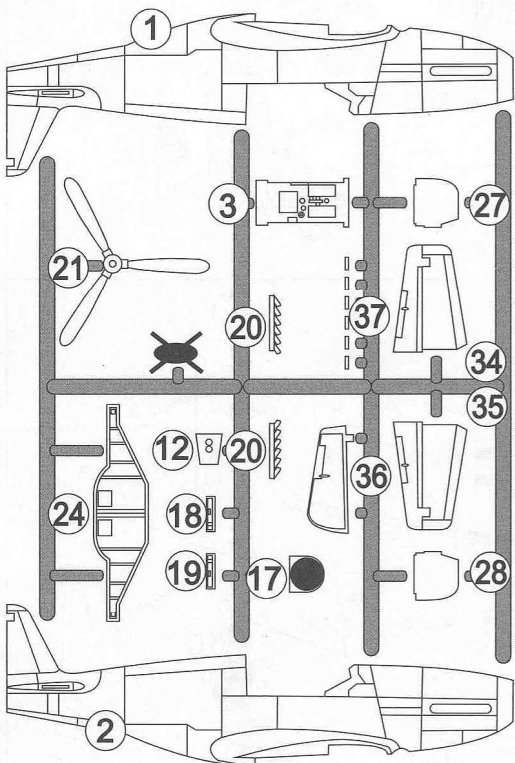

clear canopy

pur part



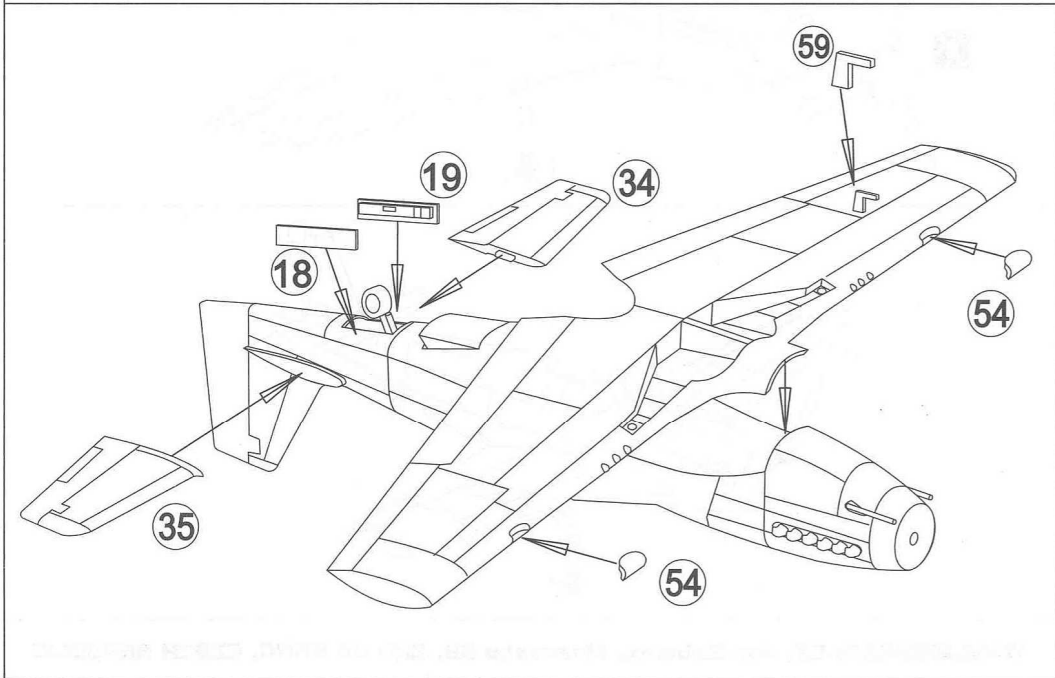
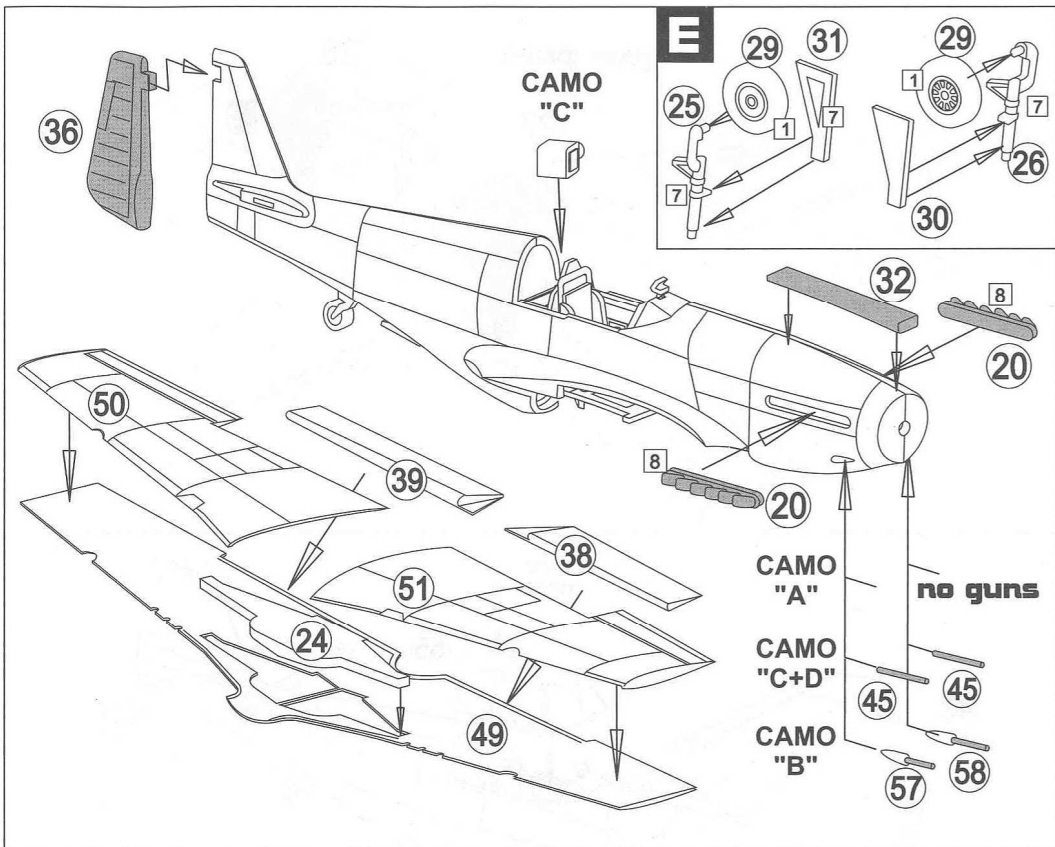

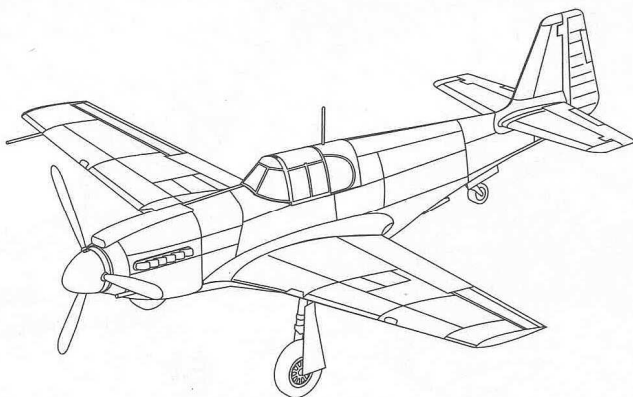
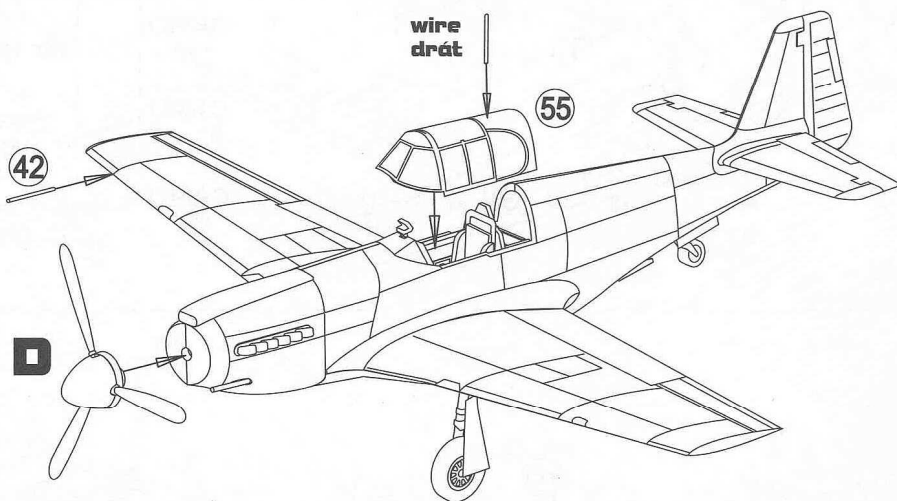
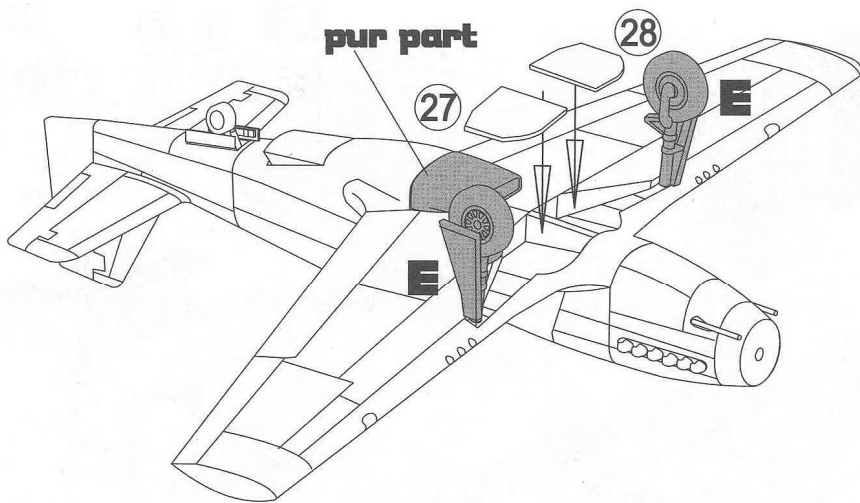

CAMO "A" Mustang 1, AL958, Californie, 1942

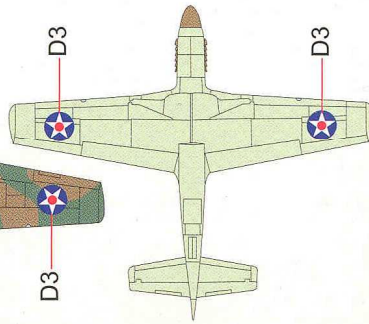
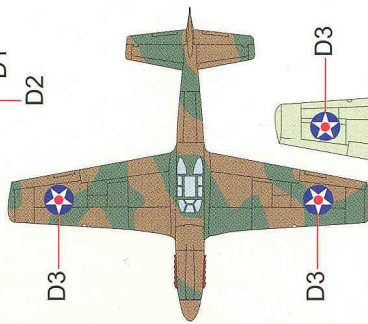
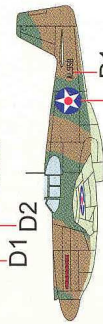
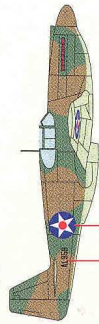

D1 D2

D3

D3

D3

CAMO "B" Mustang 1, AG348, VVS, Moscow, 1942

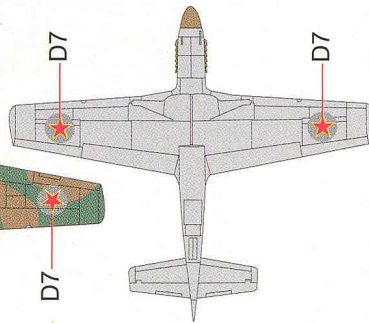
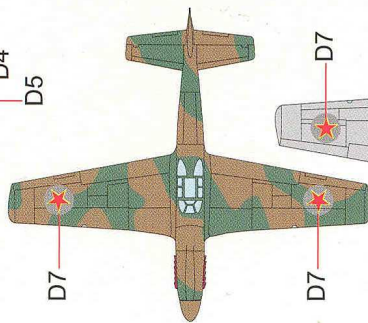
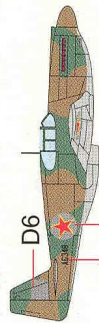

D4 D5

D7

D7

D7

CAMO "C" Mustang 1, AG633, 2. sq. RAF, 1942

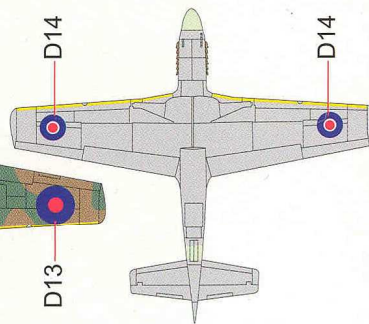
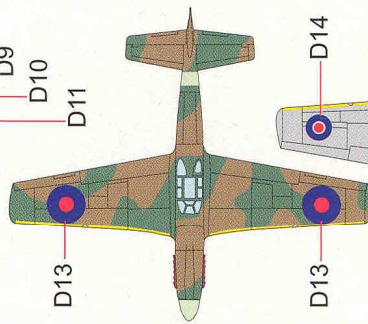

D8 D9

D13

D13

D14

CAMO "D" Mustang 1, AM148, 26. sq. RAF, 1942

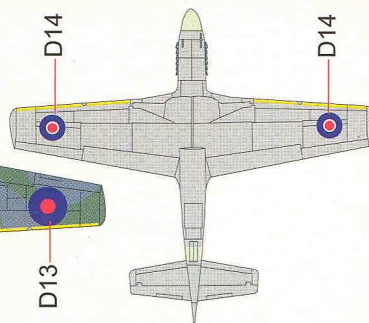
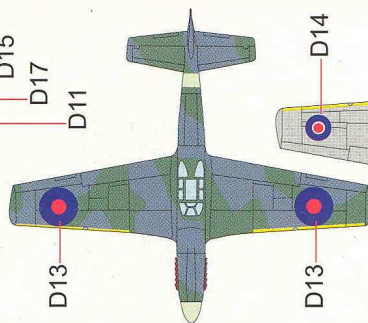
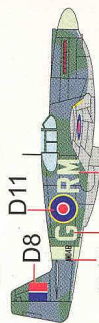

D8 D11

D13

D13

D14

Dark Green

Dark Earth

Sky

Medium Sea Grey

Ocean Grey

Yellow