

PM MODEL
P.K. 133 34712 Bakırköy
İSTANBUL / TURKEY

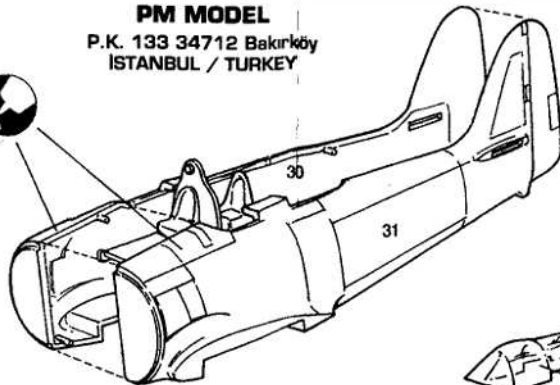

YAPIŞTIRIN
GLUE
KLEBEN

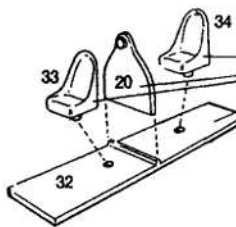

YAPIŞTIRMAYIN
DO NOT GLUE
NICHT KLEBEN



KESİN
CUT
SCHNEIDEN

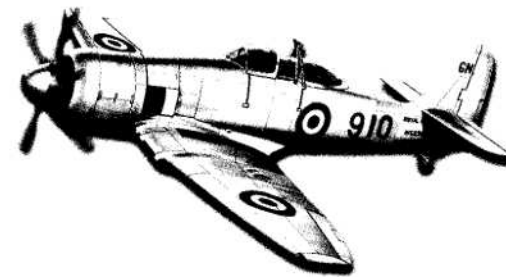
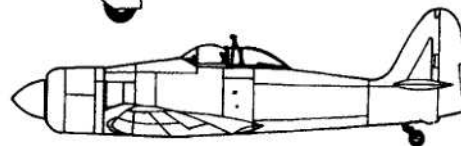
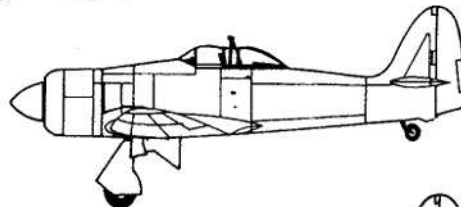
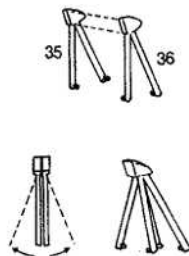
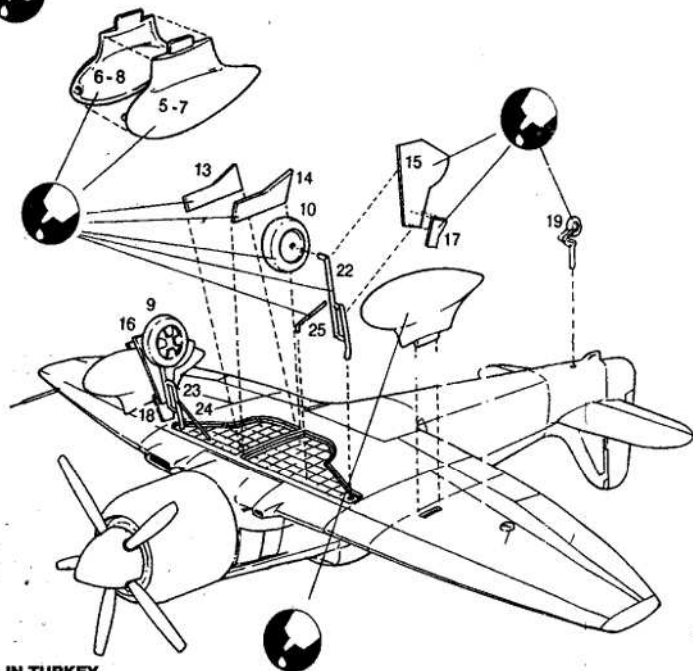
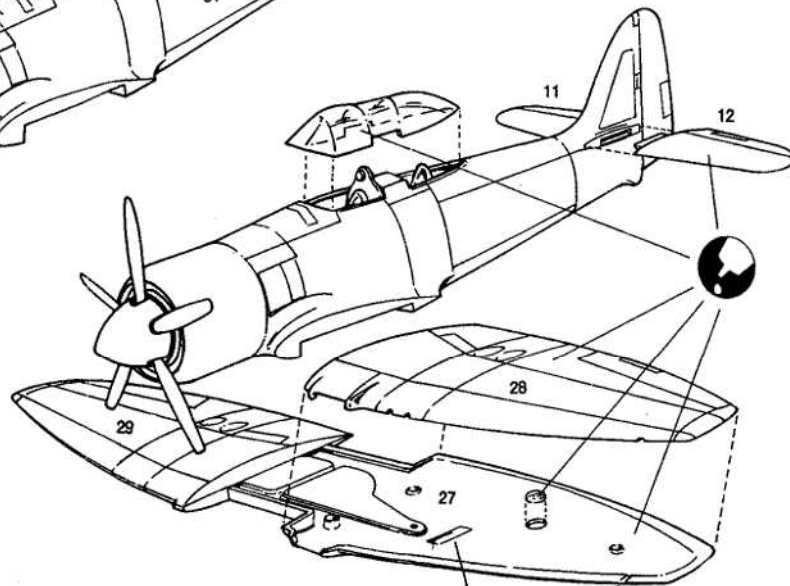
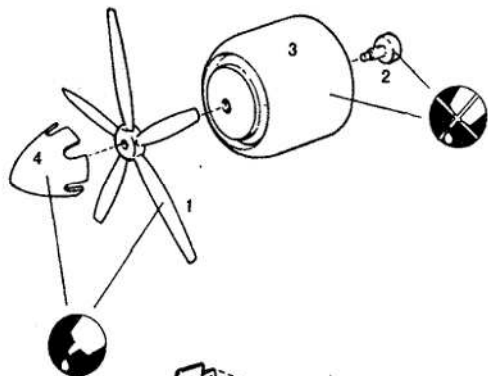

PM
MODEL
PM-212

HAWKER SEA FURY T-20

MODEL KIT \ MODELLE REDUIT \ MODELL BAUSATZ
1/72 ÖLÇEK \ SCALE \ MASSTAB \ ECHELLE

Sea Fury T-20 iki kişilik eğitim uçağı, İngiliz Kraliyet Donanmasında Sea Fury FB 11 av bombardman uçağını kullanacak pilotlar için bir geçiş eğitim uçağı olarak geliştirildi. Silahlı eğitim için, kokpit üstüne yerleştirilen bir periskoptan öğretmen pilot ön kokpitte bulunan nişangahı görebiliyordu. İngiliz Kraliyet Donanmasında yaklaşık 60 uçak hizmet gördü ve bir miktar da diğer ülkelere ihraç edildi.

TEKNİK ÖZELLİKLERİ :

Motor	: 1 x 2550 hp Bristol Centaurus
Tam yük ile ağırlık	: 5 400 kg
Maksimum hız	: 716 km/h
Kanat genişliği	: 11,69 mt.
Uçuş tavanı	: 10 850 mt.
Gövde boyu	: 10,56 mt.
Uçuş menzili	: 813 km
Yükseklik	: 4,83 mt.
Silahları	: 2 x 20mm top

The Sea Fury T-20 two seat trainer was developed as a conversion trainer for Royal Navy Pilots who were to fly the Sea Fury FB-11 fighter bomber. For armament training, the instructor pilot was given a periscope mounted over the cockpit to allow him to see the gun sight in the front cockpit. The Royal Navy operated some sixty aircraft and a number were exported to other countries.

SPECIFICATION :

Engine	: 1 x 2550 hp Bristol Centaurus
Loaded weight	: 11930 lb
Max. Speed	: 445 mph
Wing span	: 38 ft 4 inch
Ceiling	: 35 600 ft
Length	: 34 ft 8 inch
Range	: 1310 mls
Height	: 15 ft 10 inch
Armament	: 2 x 20mm cannon

Die zweiseitzige Sea Fury T-20 wurde als Trainer für die Royal Navy Piloten entwickelt, die den Sea Fury FB-11 Bomber flogen. Für das Waffentraining diente dem Ausbilder ein Fernrohr, das über dem Cockpit befestigt war, um in das vordere Cockpit zu sehen. Die Royal Navy flog sechzig Flugzeuge und einige wurden auch exportiert.

TECNICHE DATEN :

Triebwerk	: 1 x 2550 hp Bristol Centaurus
Abfluggewicht	: 5 400 kg
Höchstgeschwindigkeit	: 716 km/h
Spannweite	: 11,69 m
Dienstgipfelhöhe	: 10 850 m
Länge	: 10,56 m
Reichweite	: 813 km
Höhe	: 4,83 m
Bewaffnung	: 2 x 20 mm Kanonen

Sea Fury T-20 İngiliz Kraliyet Deniz Kuvvetleri Tarihi Uçuş Grubu Yeovilton 1989
Royal Navy Historical Flight Yeovilton 1989

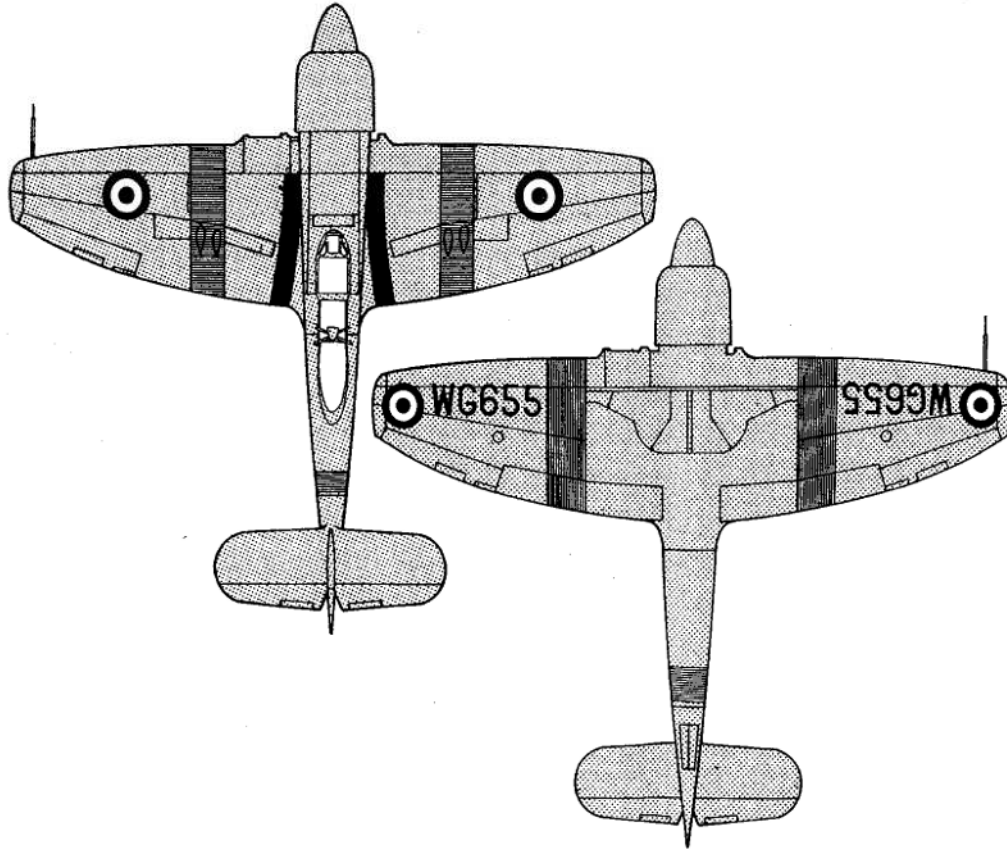
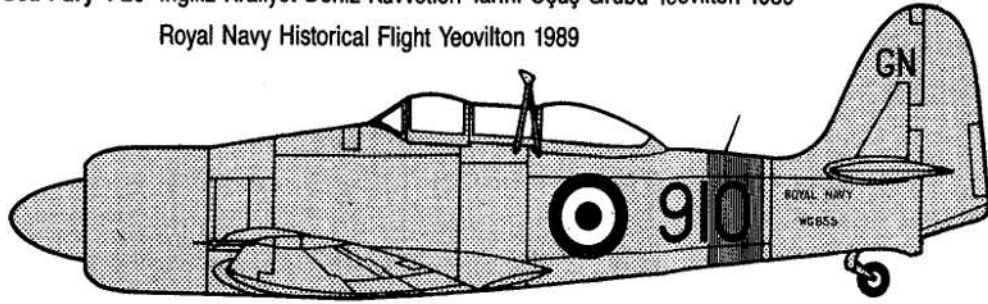

	TÜRKÇE	ENGLISH	GERMAN	FS	HUMBROL AUTHENTIC	HUMBROL	REVEL	XTRA COLOR	MOLAK	MODEL MASTER	POLLYS	GUNZE SANGYO	TAMIYA
	METAL	NATURAL METAL	SILBER	17178	HB-14	11	90	X-501	24	2714	PF-17	H-8	X-11
	EĞİTİM SARISI	TRAINER YELLOW	TRAINER GELB	33538	HT-6	24	15	X-11	30	1708	F-3	H-329	-

Sea Fury T-20 Deutsch Luftfahrt Beratungsdiens (DLB) Firması Batı Almanya 1961
Deutsch Luftfahrt Beratungsdiens (DLB) Firm West Germany 1961

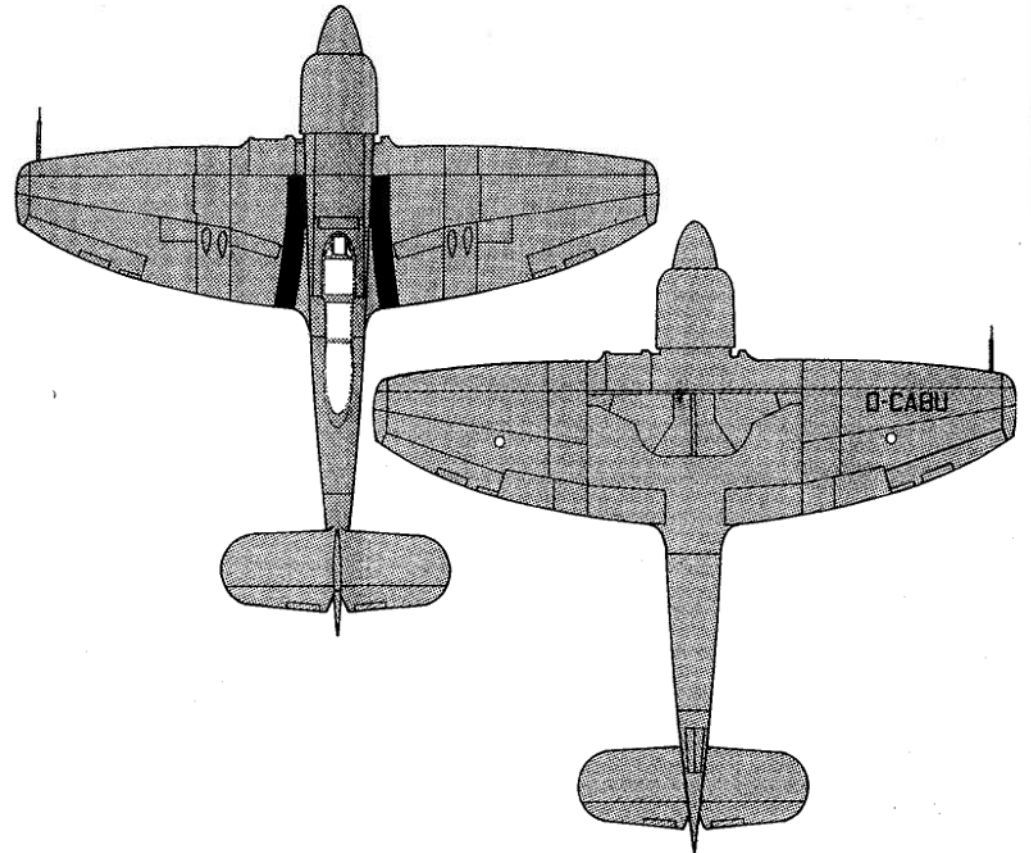
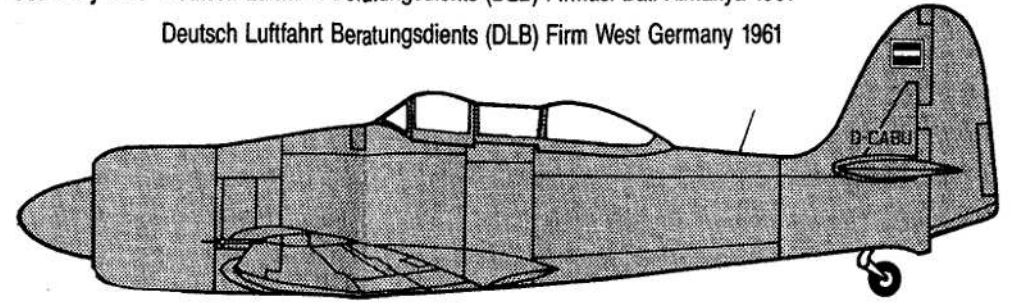

	TÜRKÇE	ENGLISH	GERMAN	FS	HUMBROL AUTHENTIC	HUMBROL	REVEL	XTRA COLOR	MOLAK	MODEL MASTER	POLLYS	GUNZE SANGYO	TAMIYA
	PARLAK KIRMIZI	BRIGHT RED	HELL ROT	11105	HM-9	19	31	X-31	4	2718	-	H-3	X-7
PERVANE PROP LUFTSCHRAUBE	MAT SIYAH	MATT BLACK	MATT SCHWARZ	37038	HB-10 HU-12	33	8	X-12	FSC-2M 2M	1749	IV-1 PF-10	H-2 H-12	X-01 XF-01