

"Jamás en la historia de la aviación, un pequeño grupo de pilotos logró tanto, en medio de tantas adversidades..." In Memoriam

**1** Douglas A-4Q Skyhawk 3-A-307  
Capt. Alberto Philippi; 1st Air Naval Attack Squadron  
San Carlos Bay, May 21, 1982; Destroyed in Combat (DIC)

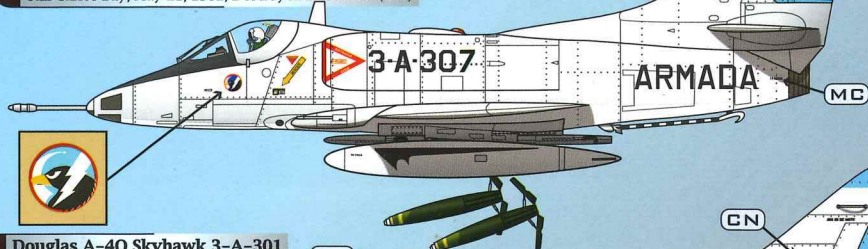

**2** Douglas A-4Q Skyhawk 3-A-301  
Lt. Roberto Sylvester;  
1st Air Naval Attack Squadron  
Rio Grande, Almirante Quijada AB  
May 21, 1982



The use of Skyhawk 3-A-301 was necessary in all Skyhawks missions, because it was the only Skyhawk with VLF/Omega system, essential to navigate on sea.

In May 23, 1982, 3-A-301, piloted by Capt. Castro Fox, attacked British ships HMS Antelope and HMS Intrepid

On May 21, 1982, six Argentine Skyhawks were scrambled to San Carlos Bay, causing the destruction of HMS Ardent.

First Squad: Capt. Alberto Philippi (A-3-307/0660)  
Lt. José Arca (3-A-312/0665)  
Lt. Marcelo Márquez (3-A-314/0667)

Second Squad: Lt. Benito Rótolo (3-A-306/0659)  
Lt. Carlos Lecour (3-A-305/0658)  
Lt. Roberto Sylvester (3-A-301/0654)

**3** Douglas A-4Q Skyhawk 3-A-305  
Lt. Carlos Lecour; 1st Air Naval Attack Squadron  
San Carlos Bay, May 21, 1982

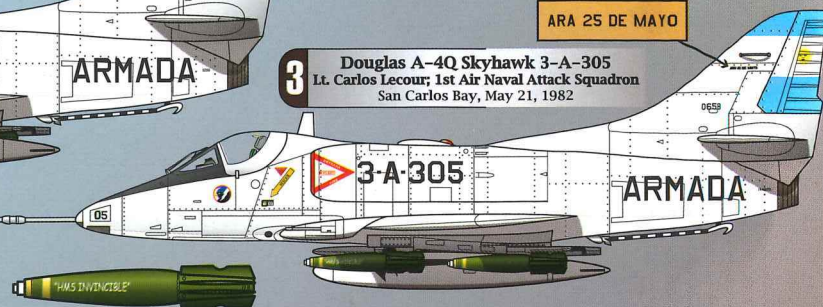

ARA 25 DE MAYO

APPROXIMATE COLORS FOR A-4Q ARMADA  
FS 26440 Light Gull Gray FS 37875 Insignia White  
Check your references

FOR ALL A-4Q SKYHAWKS  
Landing Gear White Inside Doors White, Red edge Blade Antenna White Inside Flaps Red with FLAP decal

The first sqd. attacked and made two direct hits on the HMS Ardent. Shortly after, the three planes were shot down by two Sea Harriers FRS.1 (XZ500 Ft. Lt. Leeming and XZ457 Lt. Morrell). Lt. Marcelo Márquez was killed in action.

All Skyhawks were armed only with four Mk82 500 Lb. (227 Kg.) Snake Eyes high drag bombs.

**3** Douglas A-4Q Skyhawk 3-A-305  
Lt. Roberto Sylvester; 1st Air Naval Attack Squadron  
San Carlos Bay, May 28, 1982

Find more A-4Q in the addendum instructive



APPROXIMATE COLORS  
FS 10091 FS 34259 FS 37875  
Check your references

Light Gray color of "Armada" Skyhawks made them easy targets, so in May 24, A/Cs 301, 302, 304, 305 & 306 were painted in a provisional Dark Green and Brown camouflage color scheme. Due the president Jim Carter's armaments embargo to Argentina due the Dirty War (1976-1983), Federal Standard paints were not available during war, so Argentinean Forces painted their Skyhawks with local paints, making the A/Cs had different shades of color.

Argentine Navy had some Sidewinders (AIM-9B) during the war, but it were not used in combat.

Dear Customer! Aztec always want to hear about you. Please, feel free to visit our web page for any comment or suggestion

**4** Douglas A-4Q Skyhawk 3-A-309  
Comandante Espora AB, July 1982

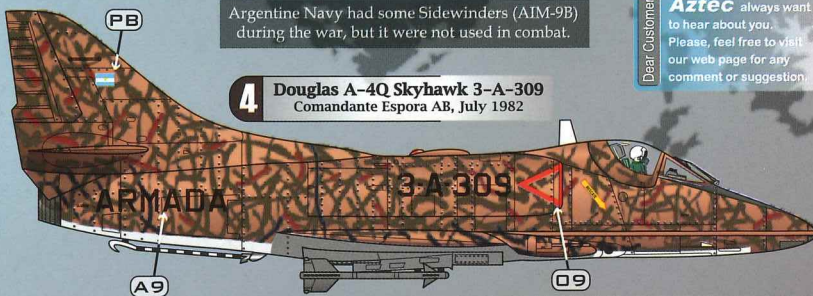

Due technical problems, 3-A-309 didn't fight in war.



APPROXIMATE COLORS FOR A-4Q 3-A-309  
FS 30118 Field Drab FS 30215 Brown FS 37875 Insignia White FS 31136  
Check your references

APPROXIMATE COLORS FOR CANBERRA B-108  
FS 24064 FS 36270 FS 36440  
Check your references

**5** English Electric Canberra B-108  
Capt. Roberto Pastran & Capt. Fernando Casado  
2nd Bombing Sq.,  
June 13, 1982, Destroyed in Combat

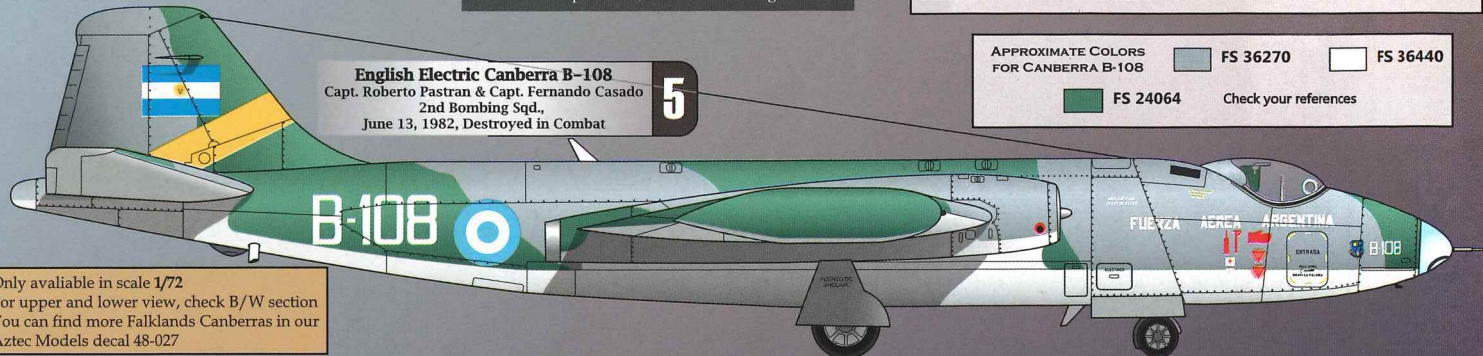

Only available in scale 1/72  
For upper and lower view, check B/W section  
You can find more Falklands Canberras in our Aztec Models decal 48-027

On June 13, 1982, at 21:30 hrs., B-108, along with B-109 and two Mirages III, flew in mission to support the defenses in Port Stanley. After the Canberras dropped their load and turned back to their base, B-108 was hit by a Sea Dart launched from HMS Exeter. Capt. Roberto Pastran could eject, landing in sea and later captured by British forces, but Capt. Fernando Casado couldn't eject, and died when B-108 crashed.



WAR FOR THE  
**FALKLANDS / MALVINAS**

**6** British Aerospace Sea Harrier FRS1 XZ457 / 14  
Lt Clive Morrell; Lt Cdr Andy Auld  
800 Naval Air Squadron,  
San Carlos Bay, May 21 & 24, 1982

Kill marks  
possibly  
used  
during war



On May 21, XZ457, piloted by Lt. Morrel, shot down Skyhawk 3-A-307 of Capt. Philippi with an AIM-9L Sidewinder, and damaged 3-A-312 of Lt. Arca with 30mm. cannon.

On May 24, XZ457 piloted by Capt. Auld shot down Daggers C-419 of Maj. Puga, and C-430 of Capt. Diaz with AIM-9L Sidewinders.

**7** British Aerospace Sea Harrier FRS1 XZ451 / 006  
Lt Alan Curtis; Lt Cdr. Nigel "Sharkey" Ward; Lt Cdr Andy Auld  
801 Naval Air Squadron; May 1 & 21; June 1, 1982



On May 1, XZ451, piloted by Lt. Curtis, shot down Canberra C-110.  
On May 21, piloted by Lt. "Sharkey" Ward shot down Dagger C-407 and Pucará A-511.  
On June 1, piloted again by Lt. "Sharkey" Ward shot down Hercules C-130 with Sidewinder P and 30 mm. cannon.

COLORS FOR  
RAF BLUE HARRIERS  
BS 640 Extra Dark Sea Grey  
Check your references

Find more Sea Harriers  
in the addendum  
instructive

**8** Westland Sea King HAS.2  
825 Naval Air Squadron; Queen Elizabeth 2  
May 27, 1982

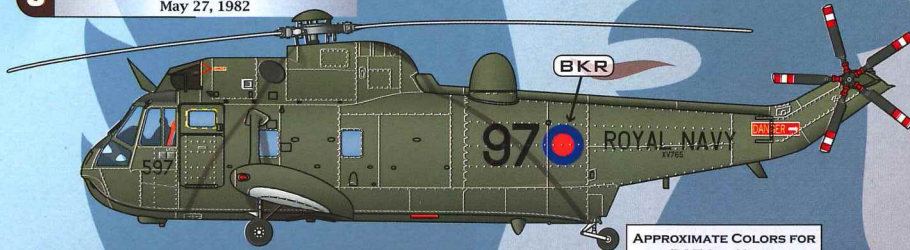

Prior, and during the travel to the Falklands, the white in English roundels were painted in blue, and white titles, unit codes and serials were overpainted in black.

APPROXIMATE COLORS FOR  
RAF SEA KINGS  
BS381 220 Olive Green  
Check your references

During Falklands War, ZA190 / 009 had two and half kills:

On May 21, Lt. Thomas shot down: Dagger C-403 & Dagger C-404, both with AIM-9L sidewinder.

On May 23, Lt. Cdr. David Braithwaite shared the shot down of a Puma AE-500 with Harrier XZ494 flown by Lt. Cdr. Gedge

**9** British Aerospace Sea Harrier FRS1 ZA190 / 009  
Lt. Steve Thomas  
801 Naval Air Squadron, HMS Invincible  
May 21, 1982



**10** British Aerospace Sea Harrier FRS1 ZA177 / 77  
Flt. Lt. David Morgan  
809 Naval Air Squadron, HMS Hermes  
June 8, 1982



On June 8, ZA 177 piloted by Lt. Morgan shot down two Skyhawks (C-226 & C-228). Kill marks were added while the A/C traveled back to Great Britain, but the marks represented two Mirages.

COLORS FOR SLATE GREY HARRIERS  
BS381 637 Medium Sea Grey  
BS 639 Light Slate Grey + 25% White  
Check your references

**7**  
A/Cs last digit  
IC decal inside  
air brake

Kill marks  
added after  
war



On May 1, ZA192 was hit by 20 mm cannons in rudder and stabilizer during a bombing raid at Stanley Port



Part of damage received



Rudder and stabilizer repaired

**11** British Aerospace Sea Harrier FRS1 ZA192 / 92  
Flt. Lt. David Morgan  
809 Naval Air Squadron, HMS Hermes; May 23, 1982  
Crashed on the sea and explode after take off from HSM Hermes



On May 23, ZA192 piloted by Lt. Morgan shot down:  
1 Puma AE-503 from CAB601, that crashed during evasive action  
1 Agusta A109 AE-337

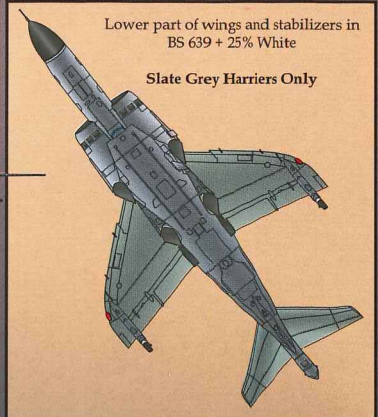

Lower part of wings and stabilizers in  
BS 639 + 25% White

Slate Grey Harriers Only



**MALVINAS ISLANDS**

**12 Douglas A-4P Skyhawk C-242**  
Tte. Luciano Guadagnini, Killed in Action  
Grupo 5 de Caza, Rio Gallegos AB  
May 23, 1982

GN GN 1B

NO PISAR

**13 Douglas A-4P Skyhawk C-236**  
Grupo 5 de Caza, Rio Gallegos AB  
June, 1982

C-236 36

**14 Douglas A-4P Skyhawk C-228**  
2nd Lt. Vazquez  
Attack to HMS Fearless, June 8, 1982; DIC

C-228 28 PB

**15 Douglas A-4P Skyhawk C-222 "El Tordillo"**  
Grupo 5 de Caza, Rio Gallegos AB  
May 21, 1982; June 8, 1982

C-222 22

APPROXIMATE COLORS FOR EL TORDILLO  
FS 36307 Gray

Three bombs in the center pylon

Find more A-4P and Mirage in the addendum instructive

APPROXIMATE COLORS FOR CAMOUFLAGE SKYHAWKS

FS 34088* Olive Drab	FS 35550 Light Blue
FS 30118 Dark Earth	FS 23655 Chrome Yellow

Wells and Main Gear: FS 25550 Light Blue  
Air brakes and flaps: Matt Red

**Note:** With the help of some friends, Aztec Models could obtain first hand info about the colors of the A-4P Skyhawks from people who were in the Argentinean Air Force during war. According with their testimony, before the war, airplanes were painted with local paints, not following the FS code. All A-4P were painted in a Olive Green/Brown color scheme. Due the different kind of paints used, with time, some shades turned brownish, darker or lighter, creating a singular color range between A/Cs that an evidence of 95 photographs shows. \* To create the Redish Brown/Brown version, we suggest you to use FS 30117 in place of FS 34088. Anyway, check your references.

C-236 C-242 C-228

IDENTIFICATION BANDS IN UPPER WINGS ONLY\*

\* SOME SOURCES SAYS IDENTIFICATION BANDS WERE PAINTED UNDER WINGS TOO, BUT PHOTOGRAPHIC EVIDENCE WAS NOT FOUND, SO WE LEAVE IT TO YOUR CONSIDERATION

MR MR

I-019 was the first Argentinean A/C shot down during the war, it was shot down by the Argentinean anti-air artillery, you can read about the event in the addendum instructive.

The camouflage of Mirage presents little variants in the design use this upper view as guide.

**16 Dassault Mirage IIIA I-019**  
Capt. Gustavo García Cuerva  
Port Stanley, May 1, 1982, 16:30 hrs, DIC

MR MB

**17 Dassault Mirage IIIA I-018**  
Rio Gallegos AB; April 1982

I-018

APPROXIMATE COLORS FOR ARGENTINEAN MIRAGE

FS 24079 Forest Green	FS 24102 Green	FS 20219 Tan	FS 26622 Light Blue	Yellow	Gloss Black
-----------------------	----------------	--------------	---------------------	--------	-------------

**Note:** Due the climate and sometimes, for the use of local paints, the existing photographic evidence shows colors clearer or darker than the Federal Standard color chart, so check your references.

**18 Sikorsky SH-3 Sea King 2-H-235**  
Circa April-May 1982

2-H-235 ARMA

**19 Sikorsky SH-3 Sea King 2-H-233**  
Pebble Island  
May 31, 1982; 20:36 hrs.

HB

APPROXIMATE COLORS FOR ARGENTINEAN SEA KING 2-H-235

FS 24052 Marine Green #23	FS 33440 Green Gold Stain	FS 36440 Light Gull Gray
---------------------------	---------------------------	--------------------------

Check your references

APPROXIMATE COLORS FOR ARGENTINEAN SEA KING 2-H-233

FS 34058 Sea Blue	FS 36440 Light Gull + 30% White Gray
-------------------	--------------------------------------

Check your references





20

**Westland Lynx 3-H-142**  
1ra. Escuadrilla Aeronaval de Helicópteros  
Comandante Espora AB  
April 2 - May 2, 1982



APPROXIMATE COLORS FOR ARGENTINEAN LYNX

White	FS 36440 Flat Gull Gray	FS 23655 Chrome Yellow
-------	-------------------------	------------------------

Check your references



21 **FMA IA-58 Pucará A-537**  
Lt. Miguel Ángel Giménez  
Grupo de Ataque 3  
Camilla Creek; 10:55 hrs.  
May 28, 1982, DIC

Find other Pucará in the addendum instructive

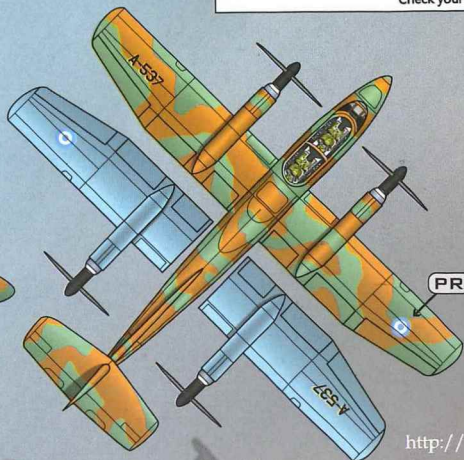

APPROXIMATE COLORS FOR PUCARÁ A-357

FS 30215 + 5% White 10% Yellow	FS 34272 + 5% Black 5% Cyan	FS 35550 + 25% Cyan
-----------------------------------	--------------------------------	---------------------

Check your references



<http://www.youtube.com/aztecmodels1>

In May 28, 1982, Pucará A-537 shot down English Westland Scout XT629. Scout's pilot, Lt. Nunn, died, while his copilot, Sgt. Belcher, survived. Right after this victory, when Pucará A-537 was returning to Puerto Argentino/Port Stanley, weather's bad conditions made Lt. Giménez crashed in Blue Mountain; his body was found until 1986.

22

**Aermacchi MB-339 4-A-115**  
Lt. Guillermo Owen Crippa  
HMS Argonaut; San Carlos Bay  
May 21, 1982



In May 21, 1982, during a reconnaissance mission in solitary over San Carlos Bay, Lt. Crippa saw the approach of British fleet, and attacked the HMS Argonaut with 30mm cannons and ZUNNI rockets

APPROXIMATE COLORS FOR ARGENTINEAN AERMACCHI

FS 34258	FS 33564	White
----------	----------	-------

Check your references



In May 3, 1982, XZ247 was launched from HSM Glasgow in direction to Argentine navy ARA "Alferez Sobral", attacking it with Sea Skua missiles

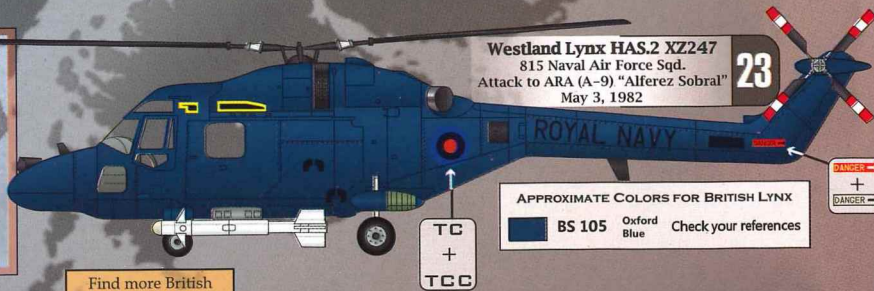

23 **Westland Lynx HAS.2 XZ247**  
815 Naval Air Force Sqd.  
Attack to ARA (A-9) "Alferez Sobral"  
May 3, 1982

APPROXIMATE COLORS FOR BRITISH LYNX

BS 105 Oxford Blue	Check your references
--------------------	-----------------------

Find more British Sea Lynx in the addendum instructive

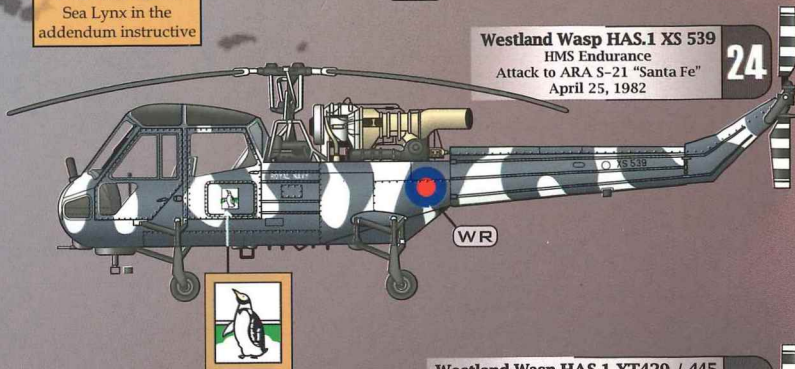

24 **Westland Wasp HAS.1 XS 539**  
HMS Endurance  
Attack to ARA S-21 "Santa Fe"  
April 25, 1982

In April 25, Westland Wasp XS 539 from HMS Endurance, and XT429, were part of an attack group that sank submarine ARA "Santa Fe" near Grytviken, in South Georgia. The attack left the submarine with several damages

25 **Westland Wasp HAS.1 XT429 / 445**  
HMS Plymouth  
Attack to ARA S-21 "Santa Fe"  
April 25, 1982

APPROXIMATE COLORS FOR BRITISH WASP

BS 640 Extra Dark Sea Grey	BS 5252 White XS 539 only
----------------------------	---------------------------

Check your references





**26** Douglas A-4Q Skyhawk 3-A-312  
Lt. José Arca; 1st Air Naval Attack Squadron  
San Carlos Bay, May 21, 1982; DIC

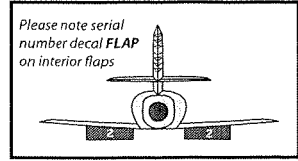
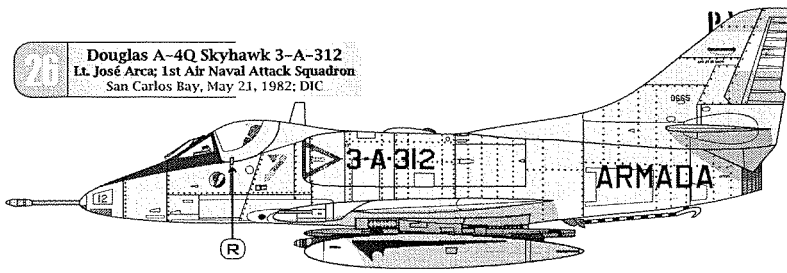

APPROXIMATE COLORS FOR 3-A-301

- FS 20100
- FS 34272
- FS 37722

Check your references

**27** Douglas A-4Q Skyhawk 3-A-301  
Rio Grande, Almirante Quijada AB  
May 25 1982

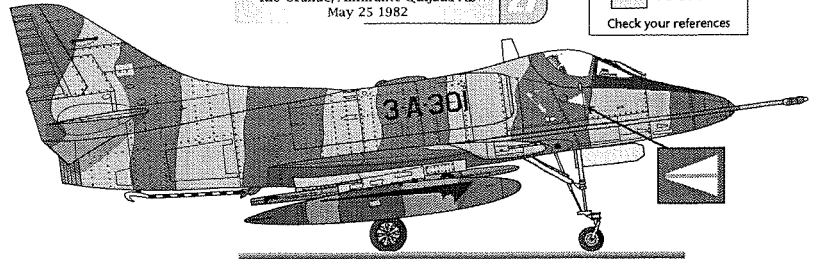

Please note the dark gray edge wings

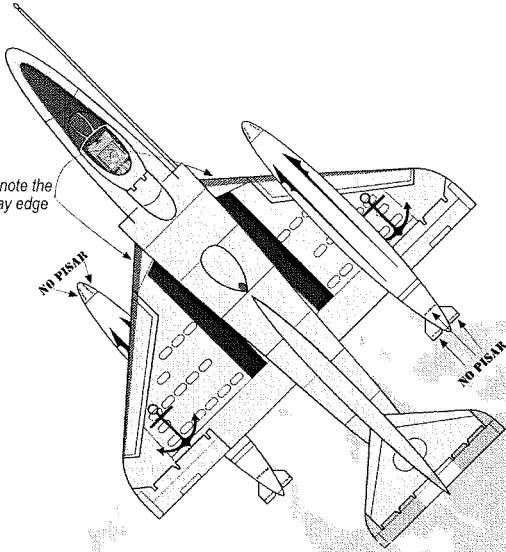

APPROXIMATE COLORS FOR 3-A-304

- FS 20215 Brown
- FS 37722 Dirty White
- FS 24127 Forest Green

Check your references

Due the use of local paints to paint A-4Q, the four A/Cs painted, even when they shared the same color scheme, no one of them shared the same colors.

**28** Douglas A-4Q Skyhawk 3-A-304  
Comandante Espora AB  
September, 1982

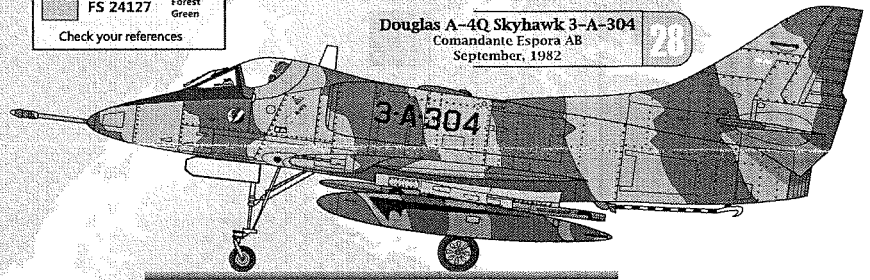

Details about each A/C can be seen/downloaded from Aztec Model's decal page:

<http://www.aztecmodels.com/048>

**5** English Electric Canberra B-108  
Capt. Roberto Pastran & Capt. Fernando Casado  
2nd Bombing Sqd.,  
June 13, 1982, Destroyed in Combat

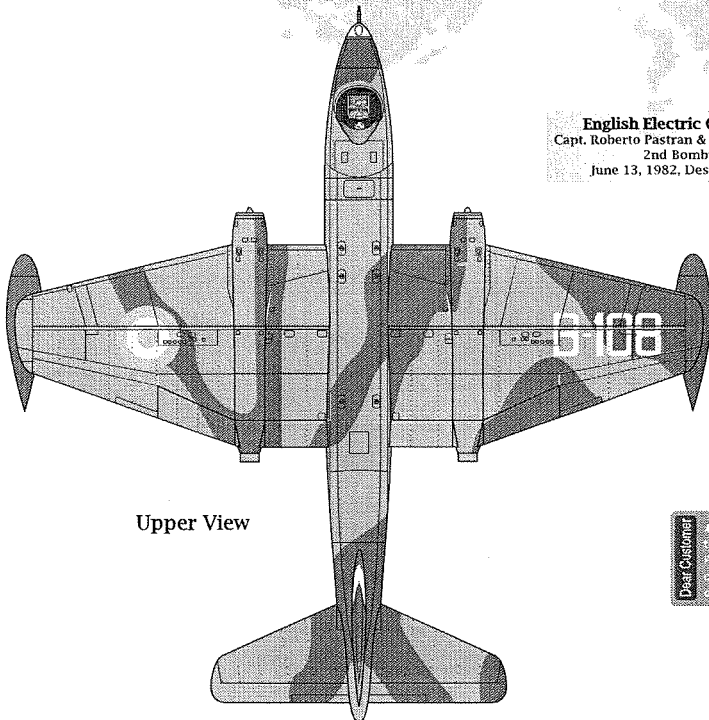

Upper View

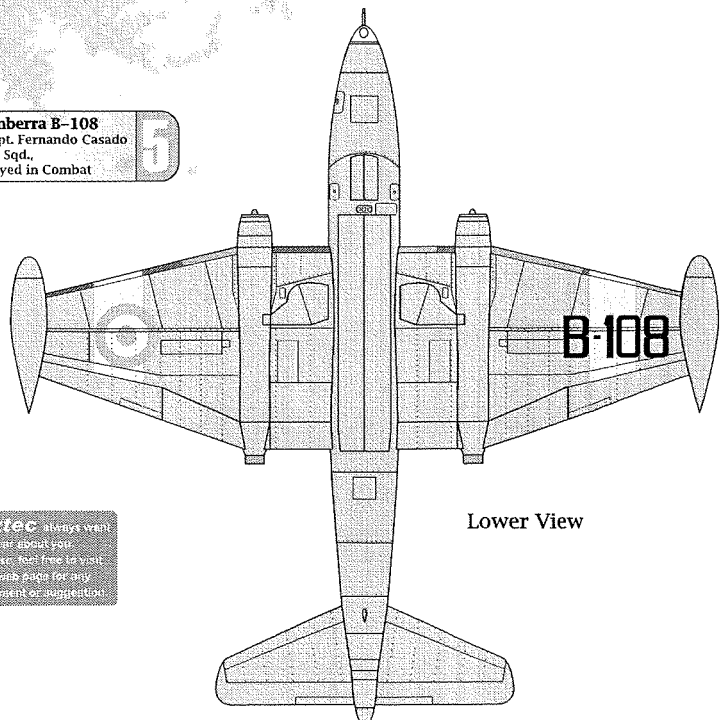

Lower View

Dear Customer, Aztec always want to hear about you. Please, feel free to visit our web page for any comment or suggestion.

# WAR FOR THE FALKLANDS / MALVINAS

## PART 1

**29** British Aerospace Sea Harrier FRS1 ZA175 / 004  
Lt. Cdr. Nigel "Sharkey" Ward  
801 Naval Air Squadron, HMS Invincible  
May 21, 1982

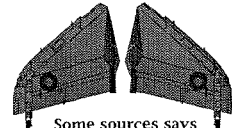
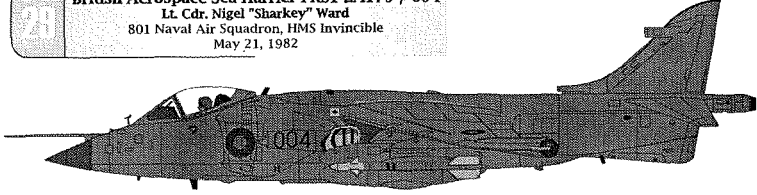

Some sources says some Royal Navy Harriers could have kept roundels under wings after paint process, also, photographic evidence shows this Sea Harriers could have used two sizes of roundels during war. Check your references.

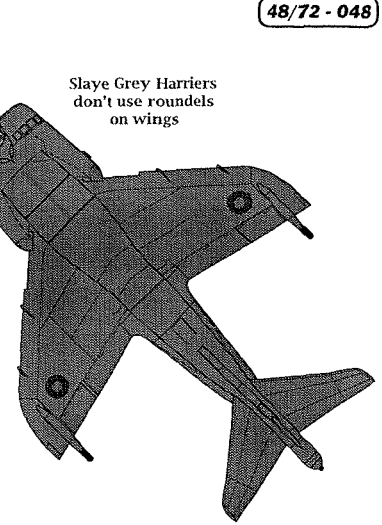

Slaye Grey Harriers don't use roundels on wings

**30** British Aerospace Sea Harrier FRS1 ZA193 / 93  
Lt. Dave Smith  
800 Naval Air Squadron, May 24, 1982



ZA193, piloted by Lt. Dave Smith, shot down shot down by Dagger C-430, piloted by Capt. Diaz, with a Sidewinder.

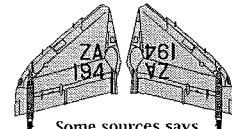

Some sources says some Slate Grey Sea Harriers could have machine's number under wings. Check your references.

**8** Westland Sea King HAS.2  
825 Naval Air Squadron, Queen Elizabeth 2  
May 27, 1982

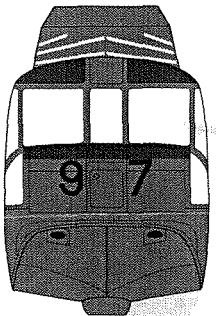

Front View

**31** Douglas A-4P Skyhawk C-207  
Attack to HMS Brilliant, May 12, 1982  
Attack to HMS Coventry, May 25, 1982

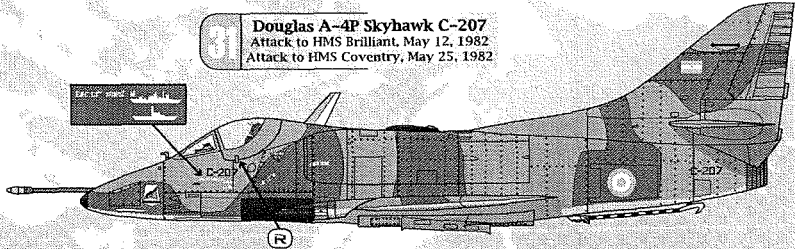

APPROXIMATE COLORS FOR SKYHAWK C-207	
	FS 34088 Olive Drab
	FS 30118 Dark Earth
	FS 35550 Light Blue
Wells and Main Gear: FS 25550 Light Blue	
Air brakes and flaps: Matt Red	
Check your references.	

According with photographic evidence, A-4P Skyhawks with kill marks, doesn't have identification bands

**32** Douglas A-4P Skyhawk C-222 "El Tordillo"  
Cerca July, 1982

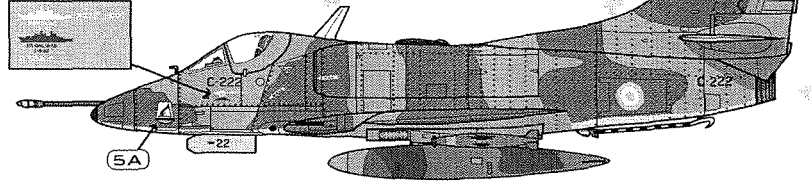

At the end of war, El Tordillo was painted with a green/brown cammto scheme

APPROXIMATE COLORS FOR EL TORDILLO	
	FS 34095 Field Green
	FS 20109 Red Brown
	FS 25550 Light Blue
Wells and Main Gear: FS 25550 Light Blue	
Air brakes and flaps: Matt Red	
Check your references	

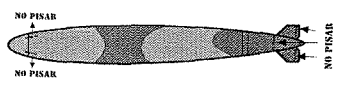

Details about each A/C can be seen/downloaded from Aztec Model's decal page:  
<http://www.aztecmodels.com/048>

Before the war, the Argentinean AF made some combat trainings with the Brazilian Air Force. Some of the Argentinean Mirage wore the emblem of the 1/14 (Primeiro do Decimo Quarto) Grupo de Aviação of the Brazilian Air Force, where appears a character named "Ze Gaúcho", based in character Ze Carioca (José Carioca), from Disney's movies "Saludos Amigos" and "The Three Caballeros"

**33** Dassault Mirage IIIEA Unidentified  
July 9, 1984

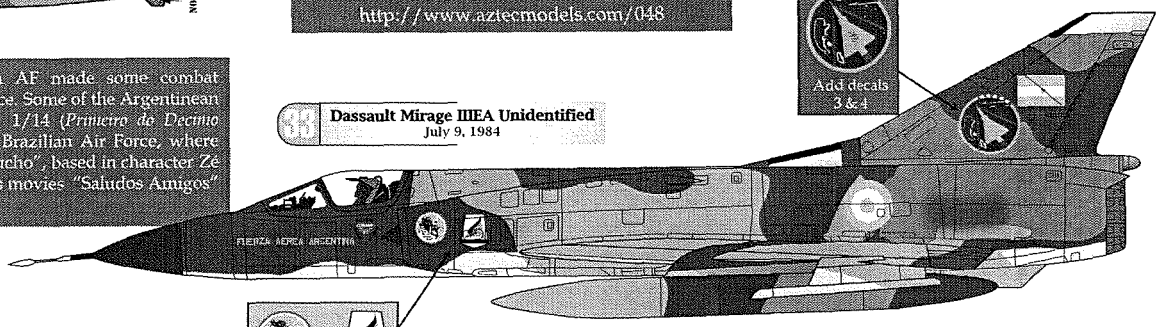

Add decals 3 & 4



# WAR FOR THE MALVINAS / FALKLANDS PART 1

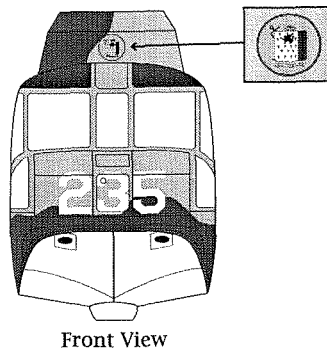
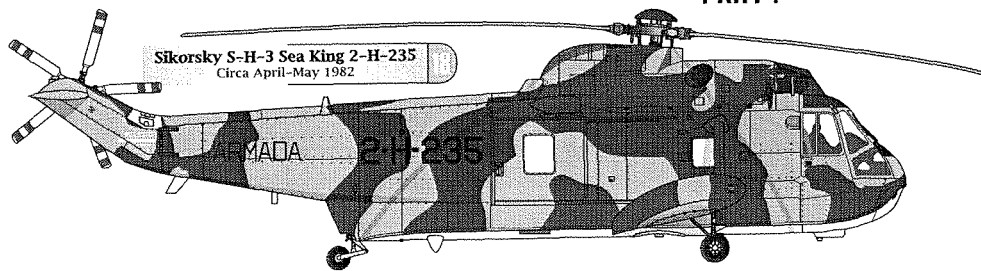

**Sikorsky SH-3 Sea King 2-H-233**  
Pebble Island  
May 31, 1982; 20:36 Hrs.

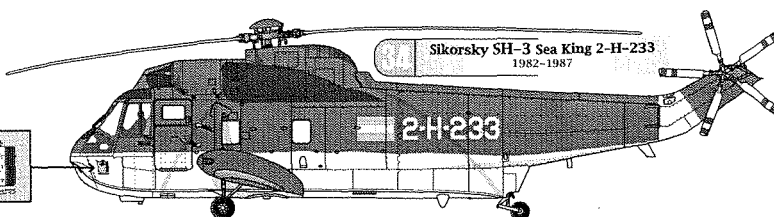
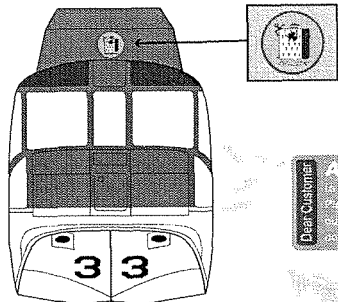

**Dear Customers:**  
Aztec always want to hear about you. Please feel free to write us with page requests, comments or suggestions.

Details about each A/C can be seen/downloaded from Aztec Model's decal page:  
<http://www.aztecmodels.com/048>

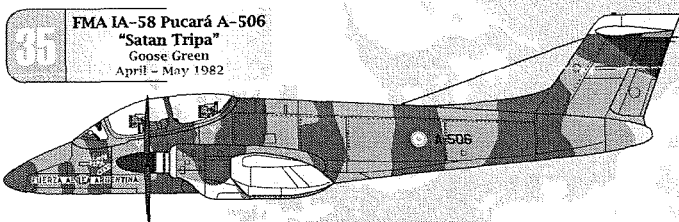

"Satan Tripa" (satan guts) received terminal damaged in May 1, 1982, so it was used as a decoy.

APPROXIMATE COLORS FOR PUCARÁ A-506

FS 30475	Saudi Color #11	FS 34227	Medium Gray Green	FS 37722	Medium Gray Green
----------	-----------------	----------	-------------------	----------	-------------------

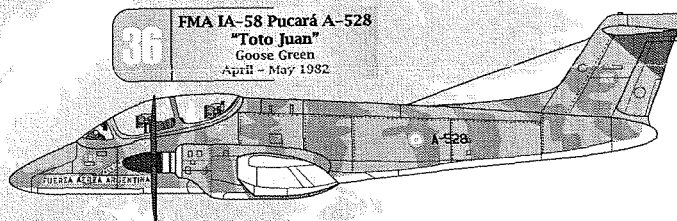

"Toto Juan" (Little John) was captured by British forces and send to the United Kingdom, where was repaired, keeping the Argentinian emblems.

APPROXIMATE COLORS FOR PUCARÁ A-506

FS 33578	FS 34672	FS 37722	Medium Gray Green
----------	----------	----------	-------------------

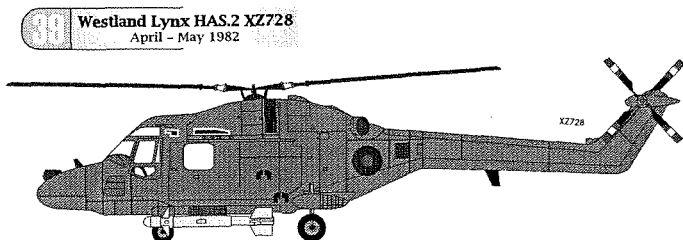
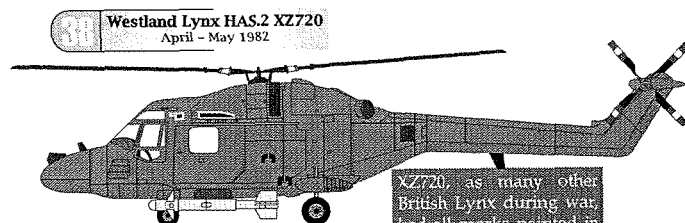
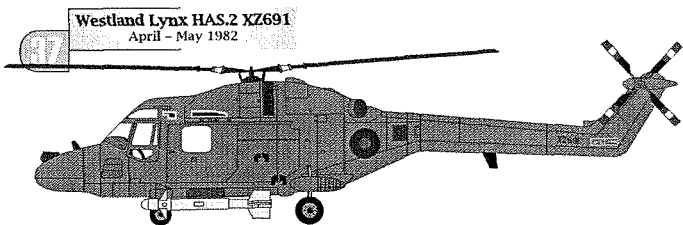



### Suggested Colors

Federal Standard	BS/BS381	Name	Humbrol	Model Master	Tamiya	Revell
10091				1701		32382
14159	639	Light Slate Grey				
20219		Sierra Tan	119	1742	XF52	32187
23655		Chrome Yellow	69	1708	XF3	
24064	641					32146
24079	241	Forest Green	116	1710	XF81	32165
24102		Dark Green	86	1713	XF58	32361
25550		Light Blue	191			
26440		Light Gull Gray	129	1726		
26622			28	1733		
30117		Earth Red	186	1701		32180
30118	450	Field Drab/Dark Earth	142	1954	XF52	32142/32187
30215				2088		36382
31136			153	1705	XF7	
33564			121			
34058		Sea Blue			XF17	
34088		Olive Drab		2050		32165
34259			150		XF49	
34272						
35044	105	Oxford Blue	189	1719	X3	
35550		Light Blue				
36118	640	Extra Dark Sea Grey	123	1723	XF24	
36270	637	Medium Sea Grey	165	1725	XF83	32374
36307		Gray	141	1726	XF20	
36440			129	1730		
37875		Insignia White	34	1745	XF2	32105
	220	Olive Green				

#### AztecModels WANTS TO THANKS TO

Claudio Moura  
Guillermo Ferrer  
Mariano Milanes  
Marcelo Carlos Moroni  
Claudio Meunier  
Juan Carlos Alberto Gómez y Sarzotti  
Luis Galves Ruiz  
Horacio J. Clariá  
Miguel Sanchez Ruiz

FOR THE DATA INFO AND PHOTOS  
FOR THE DEVELOPMENT OF THIS PROJECT.

#### AztecModels DATA BASE

SCOTT, Peter; *Air War Over the Falklands*; AIRfile Inform & Inspire. United Kingdom. 2012  
 NÚÑEZ PADÍN, Jorge F.; *McDonnell Douglas A-4Q Skyhawk*; Serie Aeronaval No. 11; Serie Aeronaval. Argentina. 2000  
 CETOLO, Vladimiro; MOSQUERA, Javier Alejandro; NÚÑEZ PADÍN, Jorge F.; *McDonnell Douglas A-4P/C Skyhawk*; Fuerza Aérea Argentina No. 2. Argentina. 2000  
 ETTOLO, Vladimiro; MOSQUERA, Javier Alejandro; NÚÑEZ PADÍN, Jorge F.; *Avions Marcel Dassault Mirage III/EA/DA*; Fuerza Aérea Argentina No. 4. Argentina. 1997  
 NÚÑEZ PADÍN, Jorge F.; *McDonnell Douglas A-4Q & A-4E Skyhawk*; Serie Aeronaval No. 24; Serie Aeronaval. Argentina. 2008  
 CHANT, Christopher; *Air War in the Falklands 1982*; Osprey Combat Aircraft 19; Osprey Aviation. United Kingdom. 2001  
 JACKSON, Robert; *Sea Harrier and AV-88*; Weapons and Warfare Series; Blandford. United Kingdom. 1989  
 MOSQUERA, Javier Alejandro; GEBEL, Guillermo Pablo; CLARIÁ, Horacio Javier; CETOLO, Vladimiro; MARINO, Atilio Enzo; POSADAS, Guillermo Sabino; *FMA IA-58 PUCARÁ 30 Años en Servicio 1975-2005*; Avialatina. Argetina, 2005.  
 MOSQUERA, Javier Alejandro; GEBEL, Guillermo Pablo; CLARIÁ, Horacio Javier; CETOLO, Vladimiro; MARINO, Atilio Enzo; POSADAS, Guillermo Sabino; *Dagger & Finger En Argentina 1978-2004*; Avialatina. Argetina, 2004.  
 ANDRADE, John M.; *Latin-American Military Aviation*; Midland Counties Publications. England. 1982  
 CICALESÍ, Juan Carlos,; DEL GAIZO, César; *Espejismos I*; Destroyer, Deyseg. Argentina. 2002.  
<http://www.fuerzaaeronavales.com/>  
<http://www.aztecmodels.com/048>