

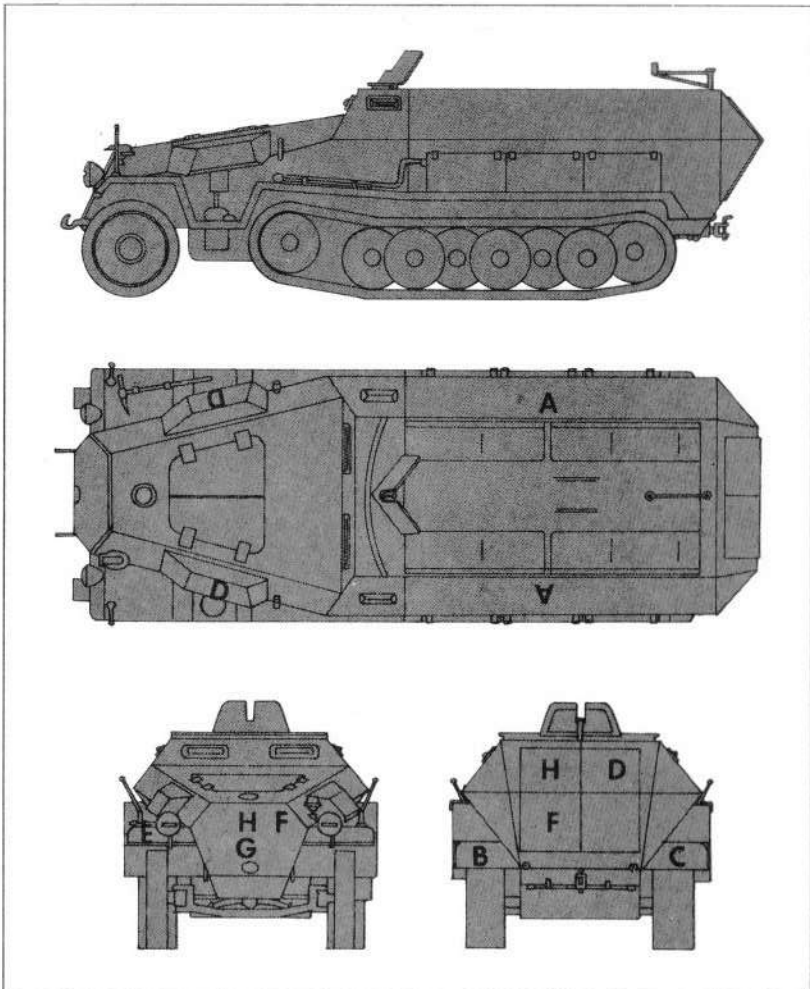













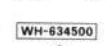





PRINTED IN JAPAN



HANOMAG Sd. Kfz. 251/1 









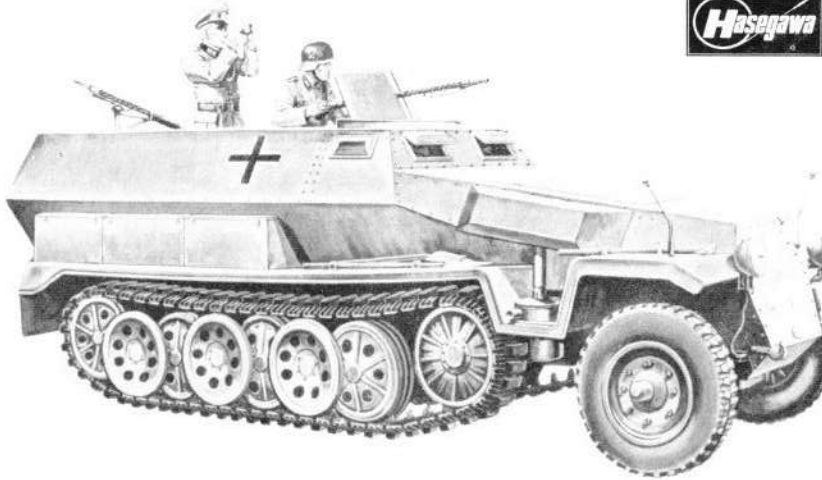

HANOMAG Sd.Kfz.251/1

mini BOX
E 2
KIT NO. MB-102

1/72 スケール ミニボックスEシリーズ
ドイツハノマーク251/1型



〈ハーフトラック・ハノマークについて〉
兵員輸送車ハノマークは1939年春Sd.kfz 251として正式採用されました。エンジンは100馬力と小さかったのですが最高速度は52.5km/hと速く機動性が良かったので同年9月のポーランド侵行作戦より北は極寒のロシア戦線から南は熱砂の北アフリカと、大戦の全期間にわたりあらゆる戦場で使われました。ポーランド戦、対フランス戦ではグデーリアン将軍が指揮車として愛用、ロンメルがSd.kfz250「グライフ」とともに有名です。

SPECIFICATION
GENERAL
CREW: 12—COMMANDER, DRIVER, 10 MEN
INFANTRY SQUAD, IN BASIC SdKfz 251/1.
BATTLE WEIGHT: 8.9 LONG TONS.
DRY WEIGHT: 7.4 TONS.
DIMENSIONS
LENGTH OVERALL: 19 ft. (AUSF. A, B AND C).
19 ft. 7 1/2 in. AUSF. D.
HEIGHT: 5 ft. 9 in.
WIDTH: 6 ft. 11 in.
WIDTH OVER TRACKS/OVERALL: 6 ft. 11 in.
TRACK CENTRES/WHEEL BASE 5 ft. in./5 ft. 3 in.
TRACK WIDTH: 9 1/4 in.

主要要目
乗員：12名 戦闘重量：8.5トン
全長：5.8m 全幅：2m 全高：2.1m
最高速度：52.5km/h
エンジン：マイバツハHL42TUKRM
6気筒100ps
武装：7.9mm機関銃 MG34×2

ENGINE
MAYBACH "HL 42 TUKRM" OR TUKRRM.
6 CYL. IN-LINE. 4,171 c.c. 100 b.h.p. AT 2,800 r.p.m. FUEL: 35 GALLONS IN ONE TANK BETWEEN FRAME.

PERFORMANCE
MAX. ROAD SPEED: 33 m.p.h.
MAX. GRADIENT: 24°.

家庭用品品質表示法による接着剤品質表示
取扱い上の注意 1. 幼児の手の届かないところに保存し、
いたづらをしない様注意して下さい。
2. 火気に注意し換気をよくして下さい。
3. 故意に吸わない様注意して下さい。
表 示 者 SZ 3000 SZ 3006 SZ 5013
部品を取り出した空袋は幼児が触ったりしないように
破り捨てして下さい。

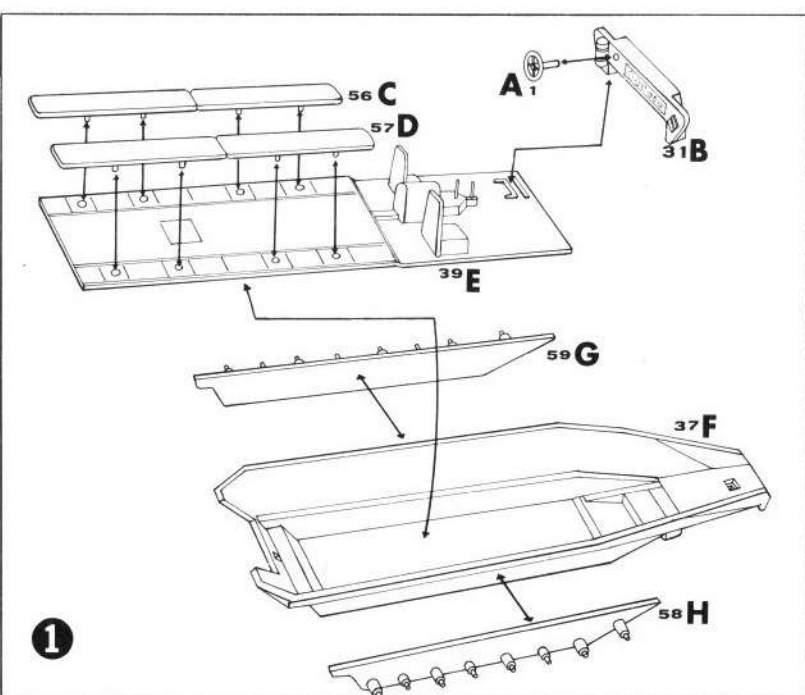
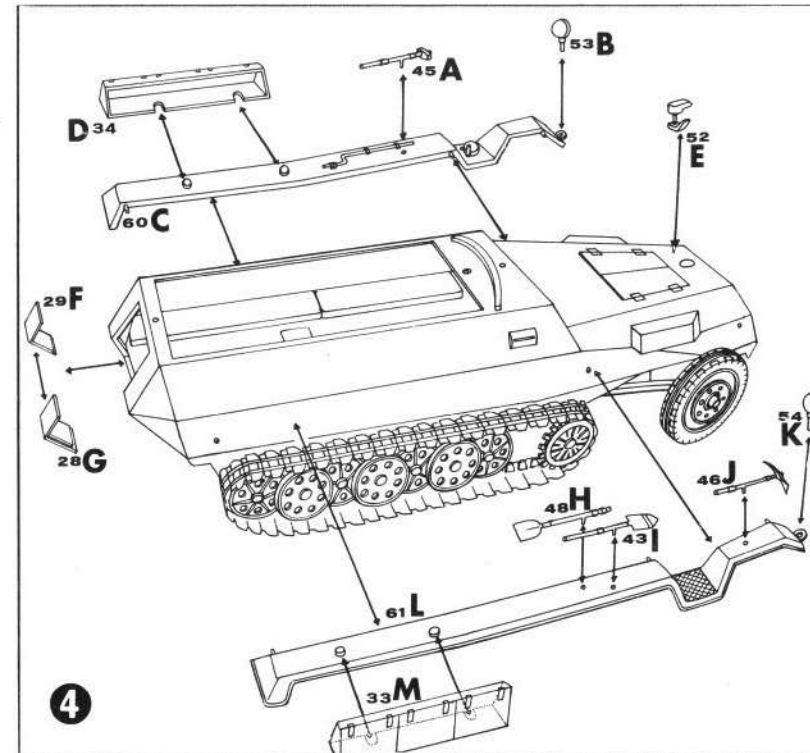
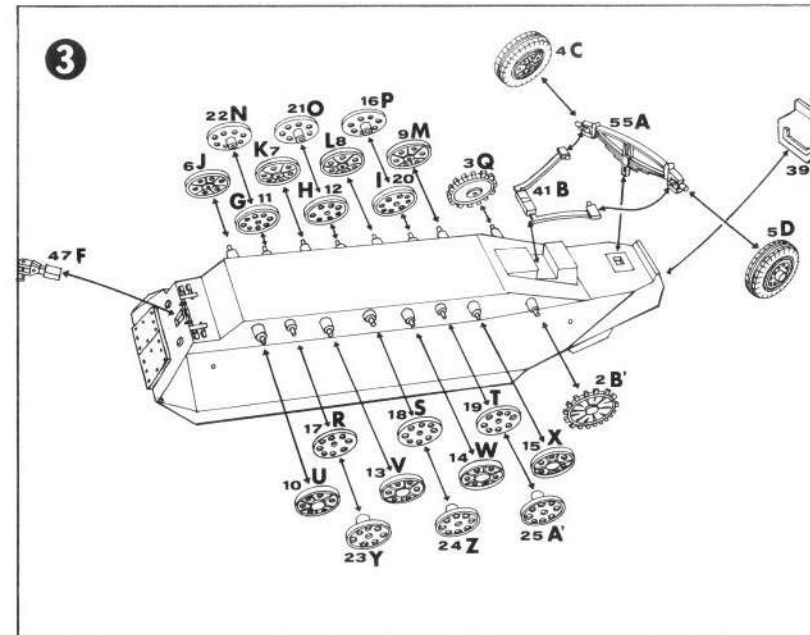
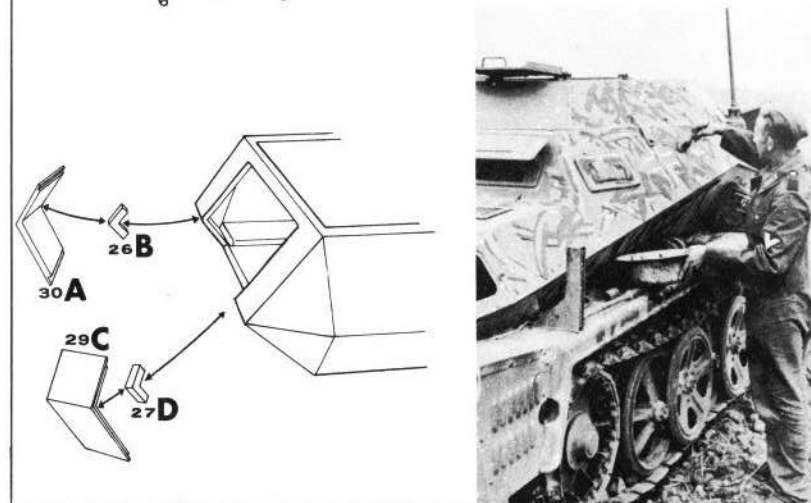
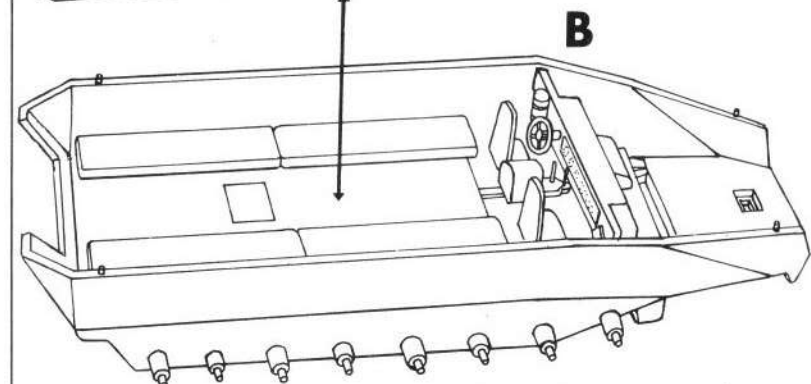
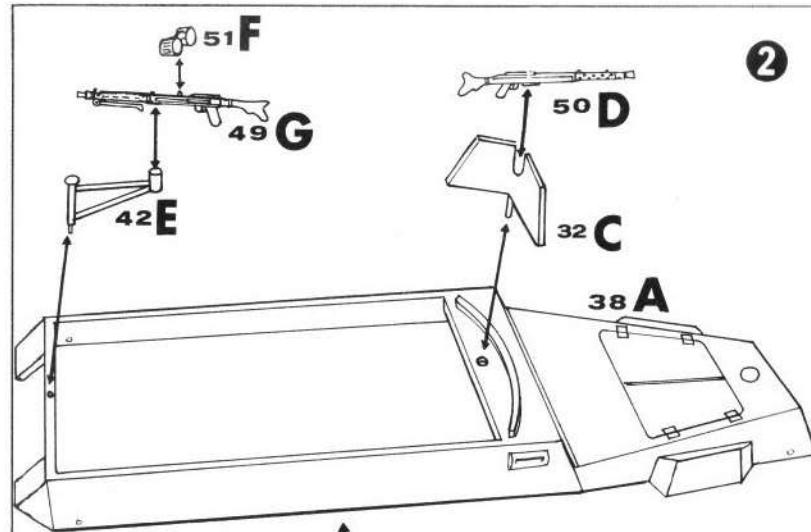
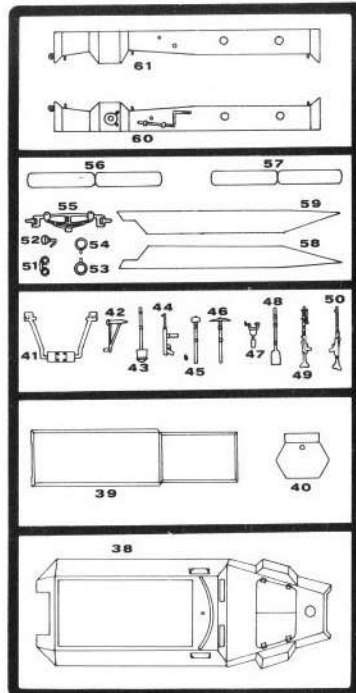
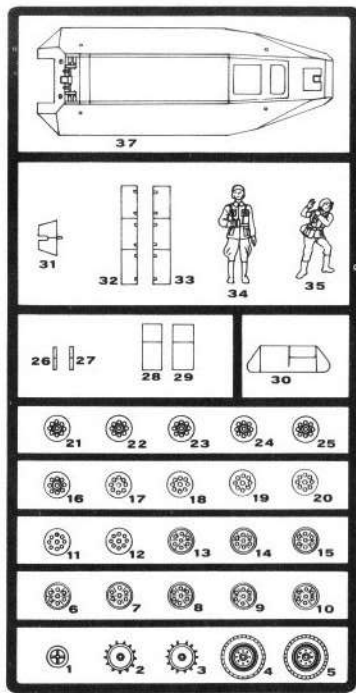

1/72 scale MiniBOX series



ミニボックスで楽しむコレクション・情景

ミニボックスシリーズ



●ミニボックスEシリーズはイタリア・エッシー社との提携商品です。今後もゾクゾクと新製品が登場しますのでご期待ください。 (株)長谷川製作所 静岡県焼津市八桶1193の2 〒425 昭和50年6月1日発行

1/9 SCALE MILITARY MOTORCYCLE SERIES

ダイナミックな迫力 あふれる重量感

1/9 ミリタリーオートバイシリーズ 発売迫る

BIGMODEL

B.M.W.R75A1

ベー・エム・ペー (6月下旬発売)

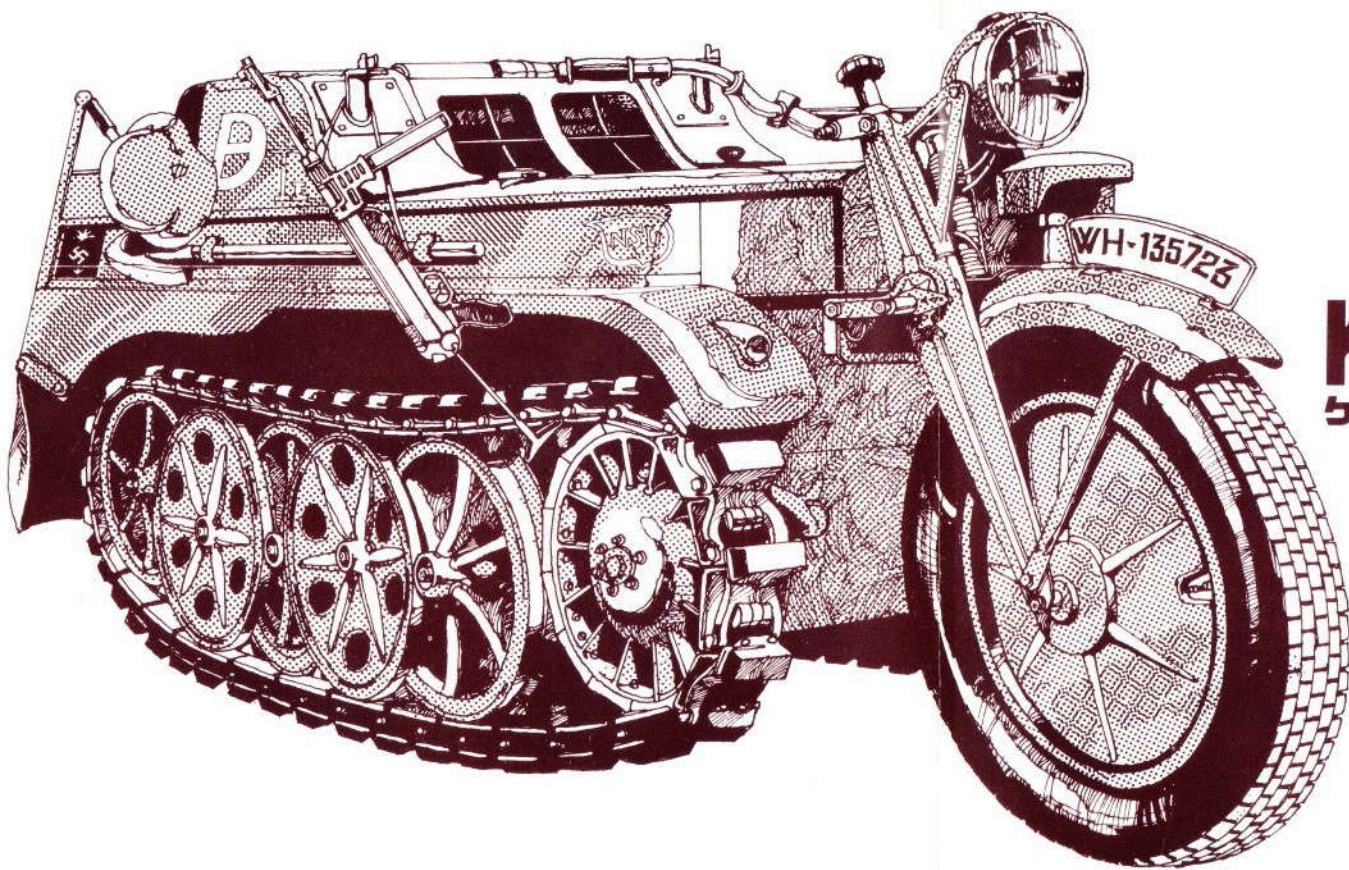
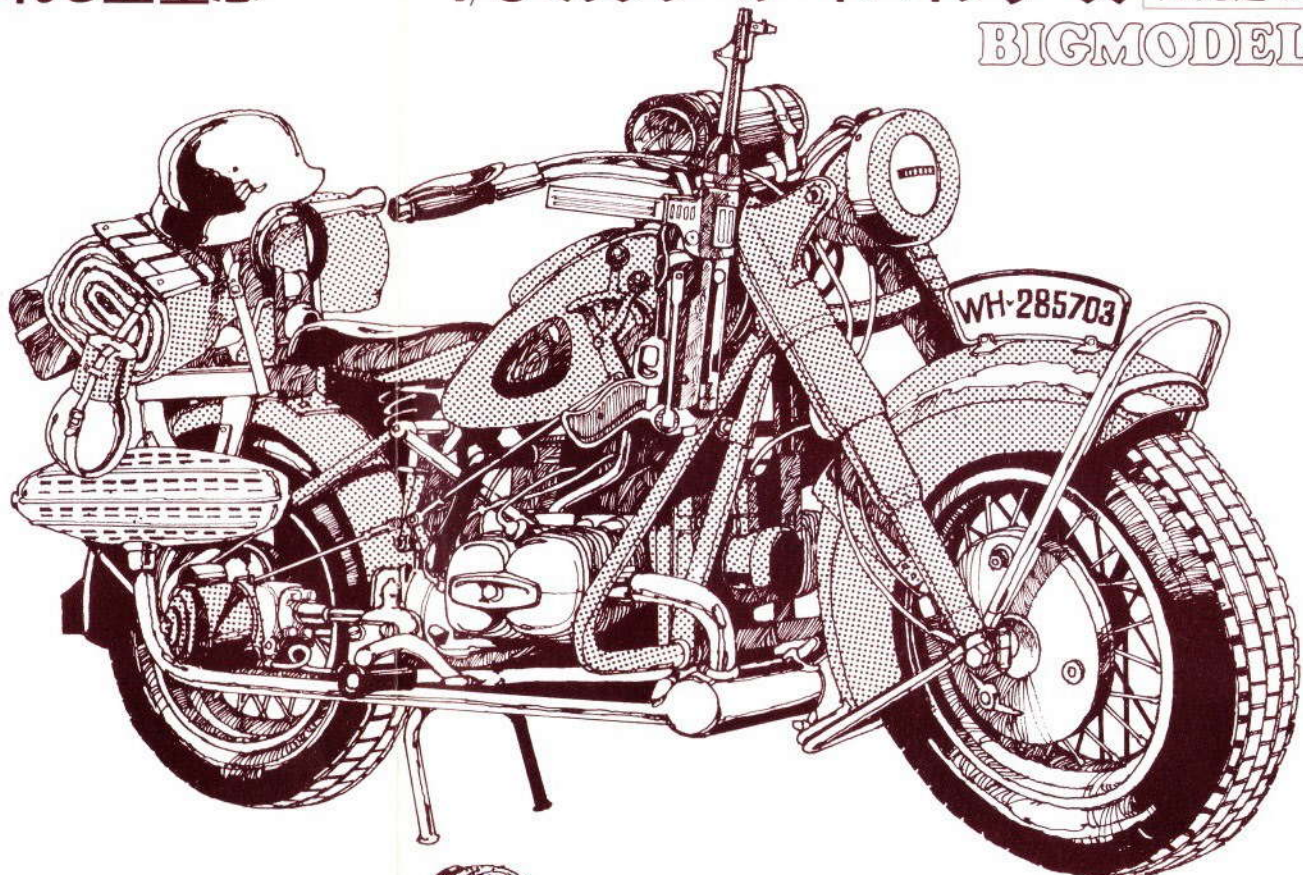

KETTENKRAD

ケッテンクラート (8月発売予定)

TRIUMPH 3HW

トライアンフ3HW (発売日未定)

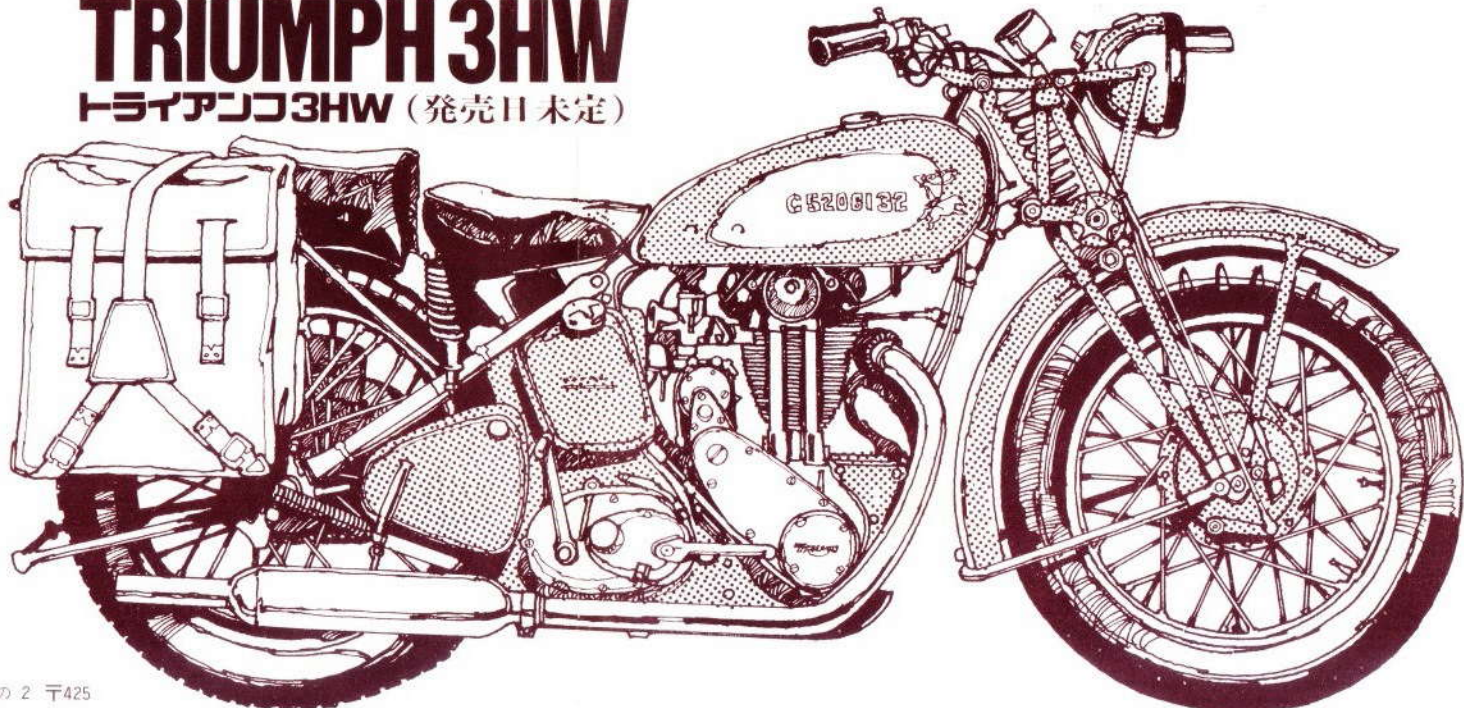

●1/9ミリタリーオートバイシリーズはイタリア・エッシー社との提携商品です。

Hasegawa

ハセガワ

株式会社長谷川製作所 静岡県焼津市八幡1193の2 〒425