

McLaren MCL35M

Monaco GP 2021 - Special Gulf Livery

MCL35M

LIMITED EDITION



CAUTION

- Read carefully and fully understand all instructions before assembly.
- Extra care should be taken when using tools avoid personal injury.
- Read and follow the instructions supplied with paint and or cement (not included).
- Use epoxy or CA glue only.
- Assemble the kit away from the reach of children.
- Keep all parts and vinyl bags away from children.
- Model car for collectors. Not suitable for under 18 years old.

ASSEMBLY INSTRUCTIONS

PART LIST

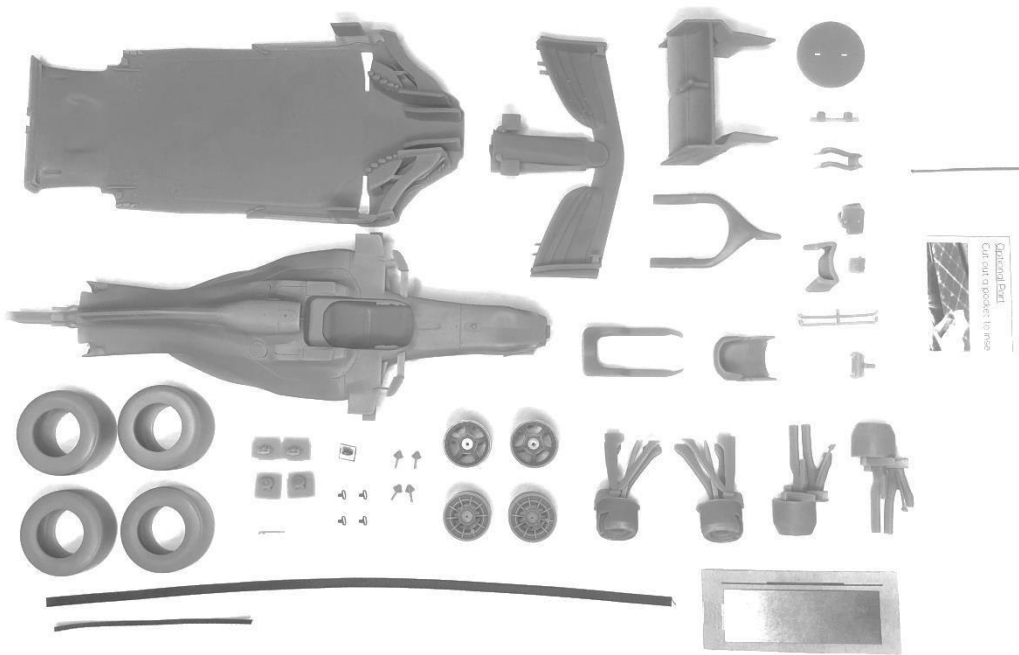

⚠️ ASSEMBLY OVERVIEW

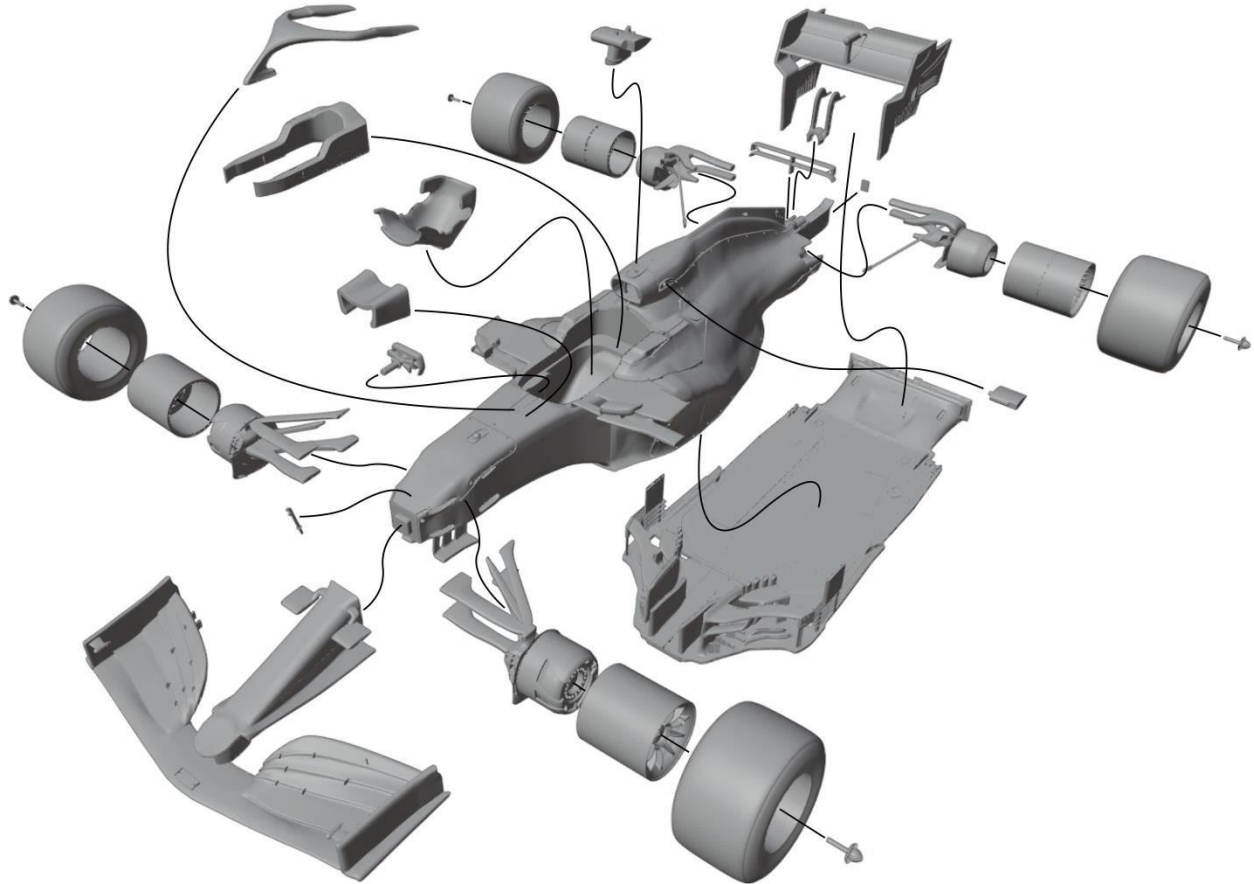



DECAL OVERVIEW

HUSK CHOCOLATE (80) DARK TRACE (1) Gulf (3) splunk (2) KAUST (5) vuse (8) vuse (4) Coca-Cola (45) 3 (15)
 Hilton (34) Buzz (53) rent-a-jet (20) RICHARD MILLE (46) vuse (18) vuse (47) Bifcc1 (50) FxPro (41) E (23) 4 (15)
 Dell Technologies (6) alteryx (51) FxPro (12) splunk (25) PARTYCASINO (11) vuse (47) Bifcc1 (30) Bifcc1 (36) 4 (15)
 McLaren (43) FxPro (19) splunk (25) DELL (23) vuse (47) Bifcc1 (30) Bifcc1 (36) 4 (15)
 3 (2) 3 (2) 4 (2)
 sparco (52) sparco (53) 4 (2)
 ZERO (36)

DECAL GUIDE

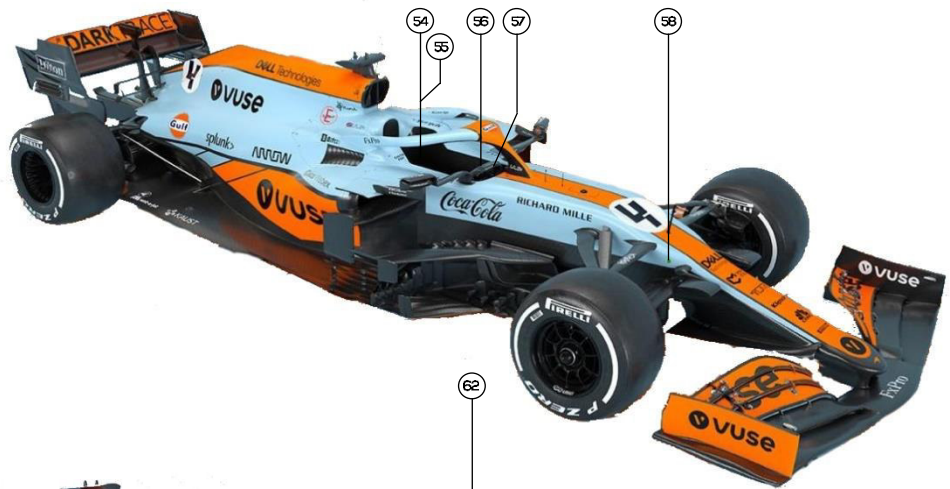
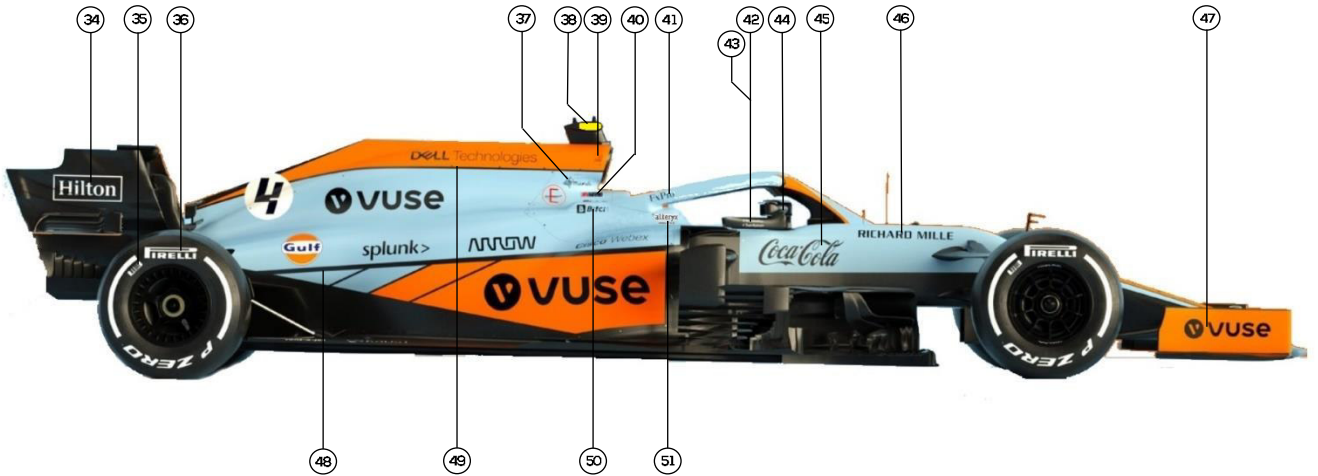
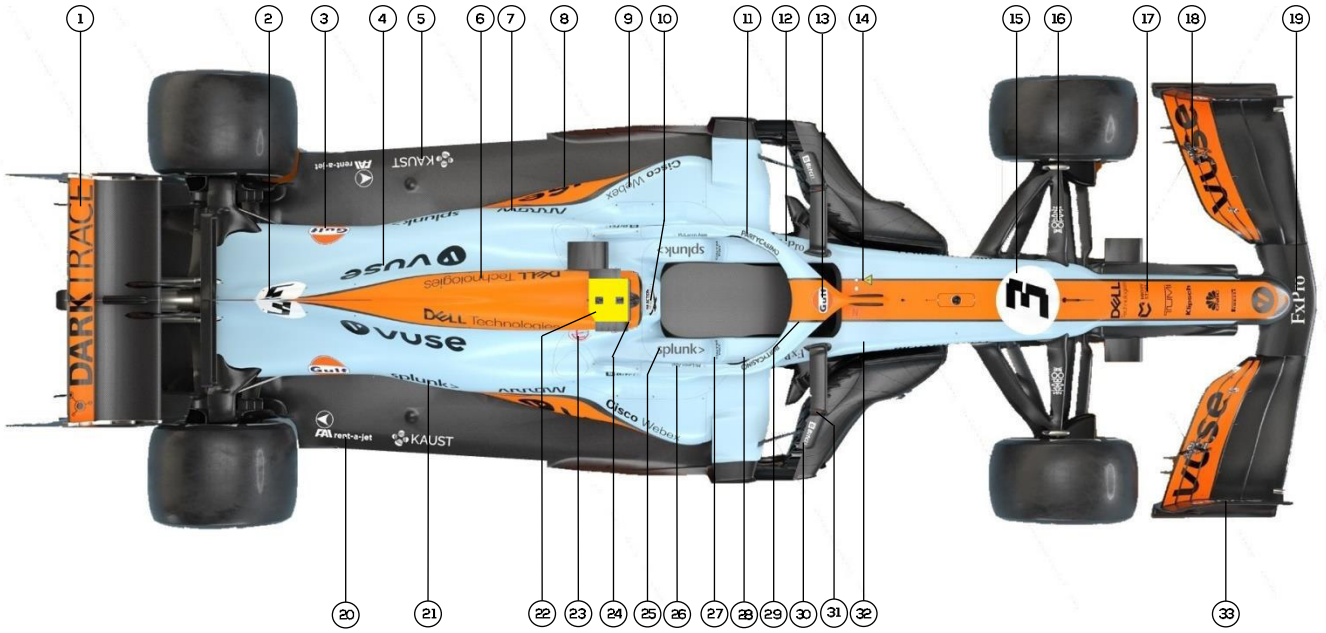

1

Remove the support structure if necessary and smooth all parts by sanding.

2

Remove the 2 joining lines on the chassis. In some cases, small printing errors are also visible on the surface. These are also sanded down or possible filled with putty.

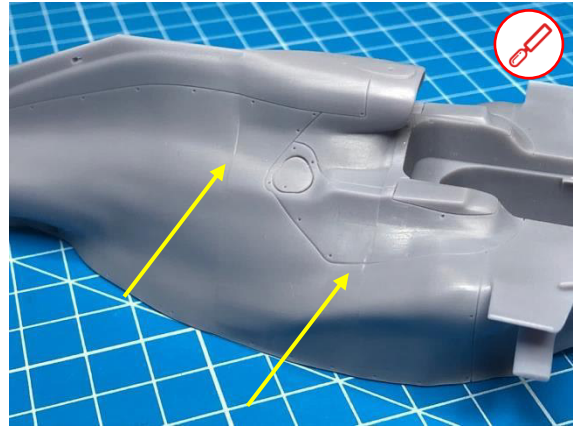
**3**

The floor area must be sanded particularly even in order to achieve a high level of accuracy of fit with the floor plate.

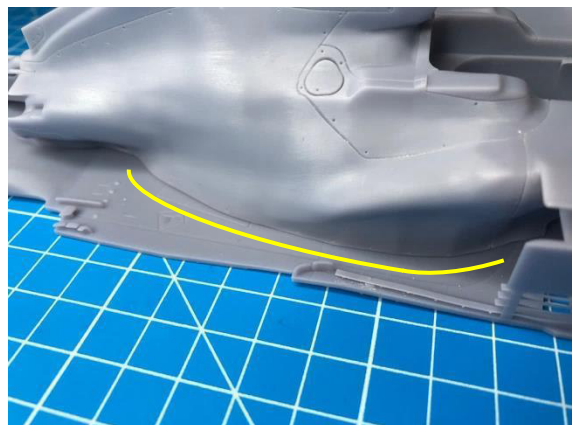
**4**

If not already done, remove the support structure in the mounts of the upper and lower wishbones. In addition, the area of the wishbones which are inserted into the nose must be adjusted so that they can be easily attached.

In order to obtain better stability of the front suspension a \varnothing 0.5-0.6mm hole must be drilled into the pushrod (thinnest arm). Then a \varnothing 0.45mm brass pin must be glued in. If necessary, also drill out the hole in the nose.

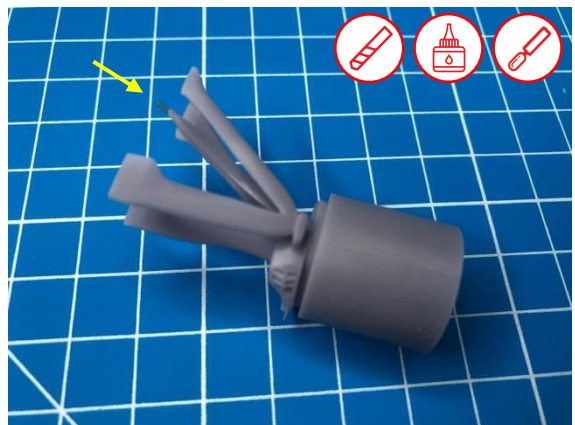
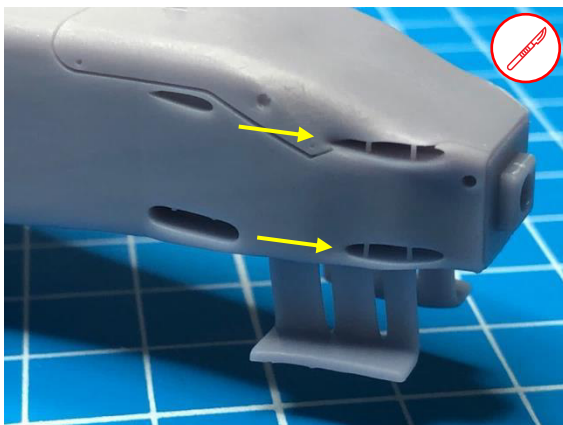

The final installation situation is shown on the left. The desired camber angle can be clearly seen in the front view on the right.

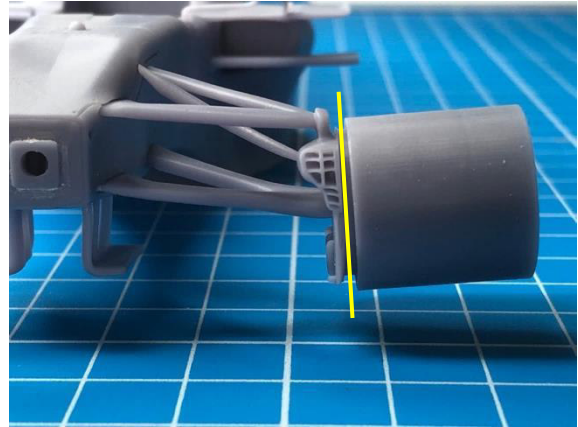
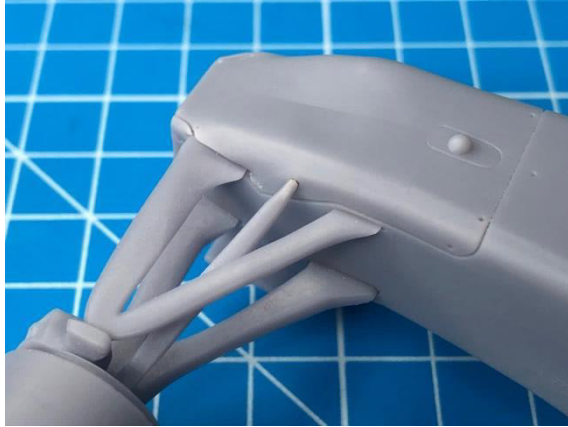

5

The wing flaps on the underside of the rear wing must be opened. The best way to do this is to use an engraving blade (0.15-0.2mm). Do it from both sides.

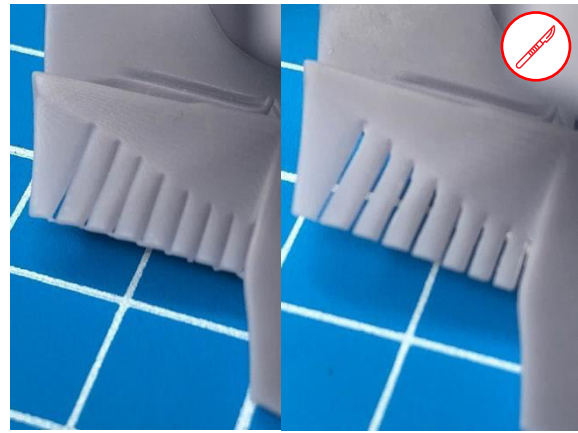

6

In order to be able to easily glue the T-cam and the side camera later, both holes have to be drilled out to approx. \varnothing 1.0mm.

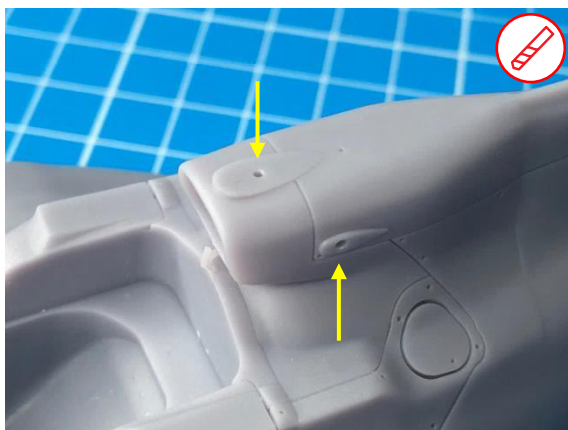

7

This area has a slight oversize of approx. 0.5mm and has to be sanded down slightly for a perfect fit. If desired, holes can be drilled in the end wall in order to connect the cockpit to the badge boards with brass pins, but gluing should be sufficient.

⚠ Attention: The thickness of the badge boards is only about 1.2mm in this area!

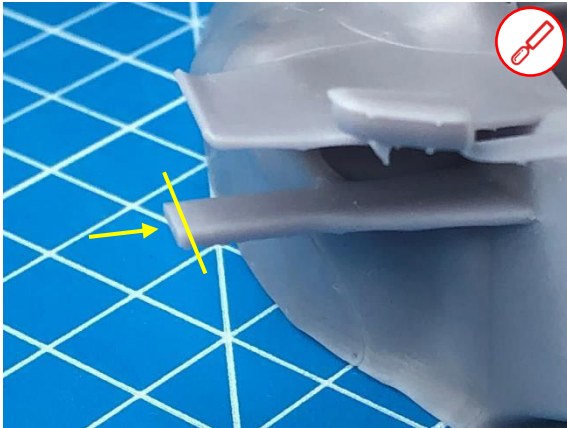

8

The square pin should fit backlash free into the opening of the nose. If necessary, the pin has to be sanded off slightly or the opening enlarged in order to achieve an optimal assembly.



9

At the rear edge of the wing elements of the front wing is a sensor on both sides. The support structure still has to be removed here.

⚠ Attention: Do not remove with a knife or pliers to avoid breaking away. Better to remove with a small file.

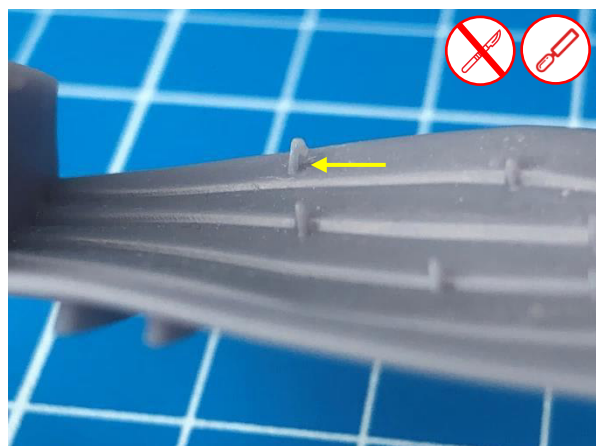
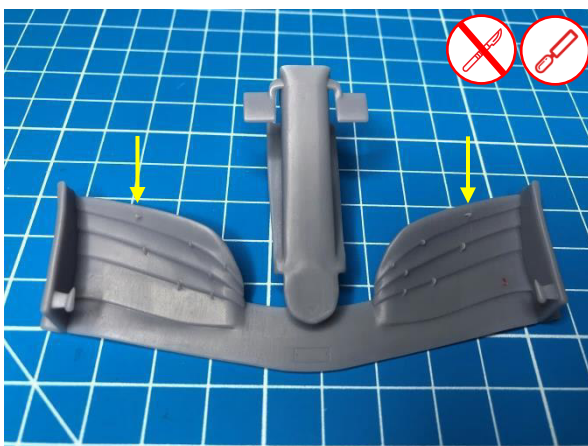

10

In order to be able to insert the central nuts of the rims, the holes have to be drilled open a little. Drill the holes with $\varnothing 1.0-1.1\text{mm}$ drill bit so that the pins of the nuts can be easily inserted.

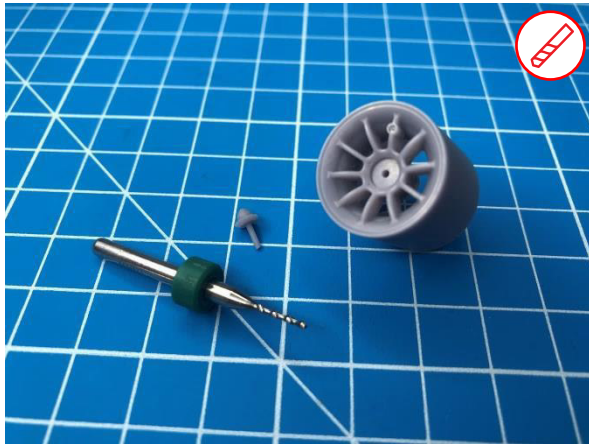
**11**

Check whether there is still support material in the area of the tow hook and remove it if necessary.

 **Attention:** Do not cut off with a knife or pliers, it is better to file off so as not to break the hook.

**12**

The contact surface of the inner cockpit border must be straightened by lightly sanding the edge with a file. It is later a covered area, so it is not absolutely necessary to do this.

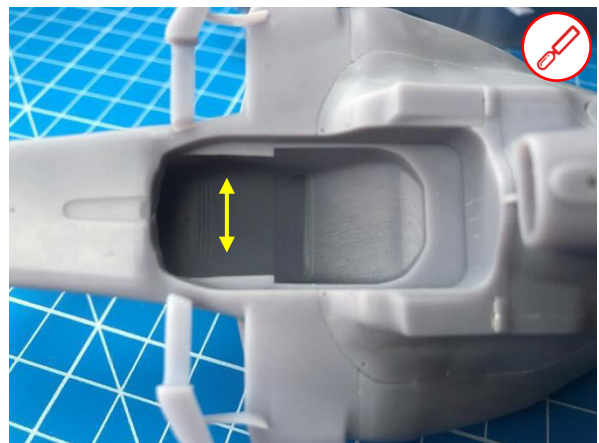
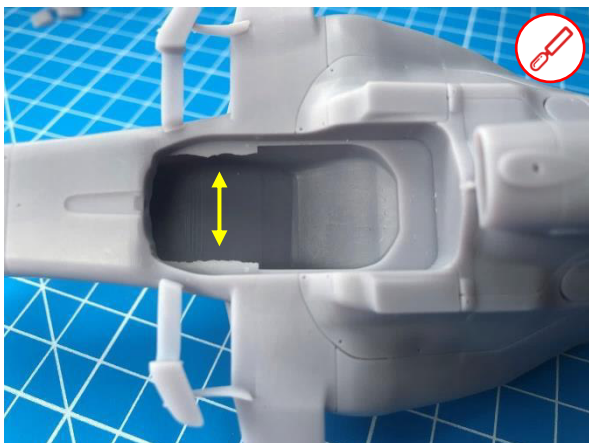

13

Check the accuracy of fit of the front bracket from rear wing. If necessary, the contour must be adjusted slightly after removing the support material in order to achieve a perfect fit on the rear wing.

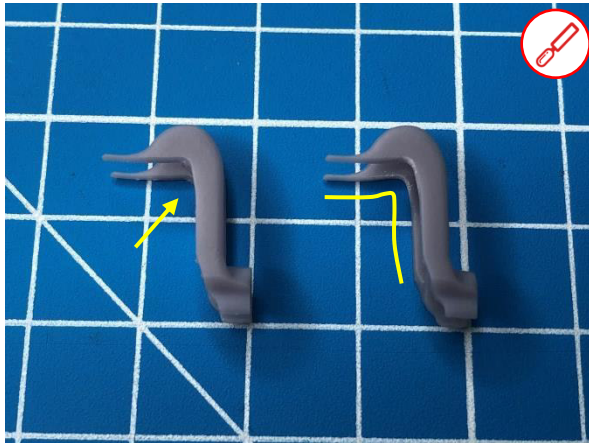
**14**

For the antennas 3 holes have to be drilled (1x $\text{\O}0.6\text{mm}$ and 2x $\text{\O}0.5\text{mm}$) and 2 antennas (length 14mm / 3.5mm) made of $\text{\O}0.45\text{mm}$ nickel silver rod. For the resin antenna use $\text{\O}0.40\text{mm}$ brass rod. Please refer to the pictures for the distances.

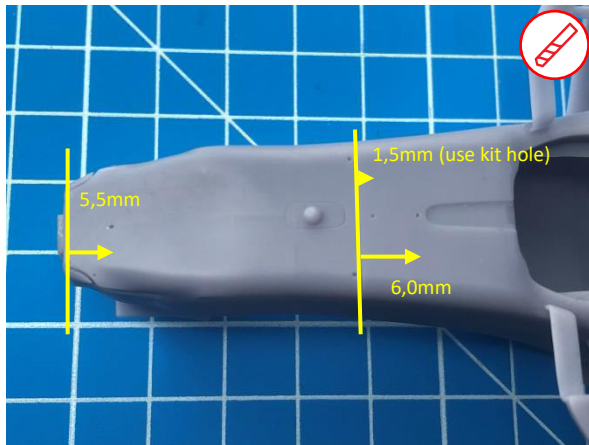
**15**

There is a groove in the engine cover for the T-wing. The wing has an oversize in height so that it can be fitted exactly. Therefore, the length must be adjusted with a file. Possibly bevel the area that plugs into the groove a little so that it can be pushed in better.

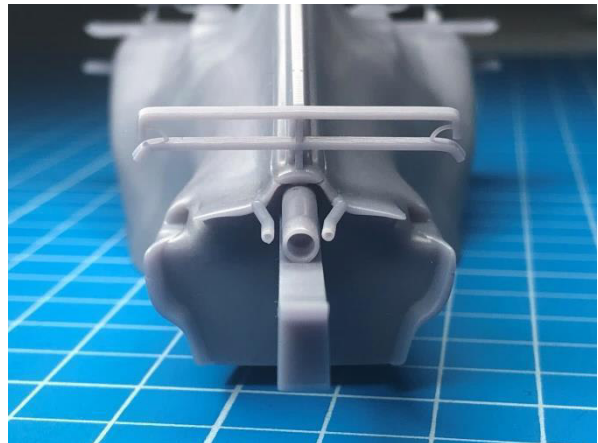
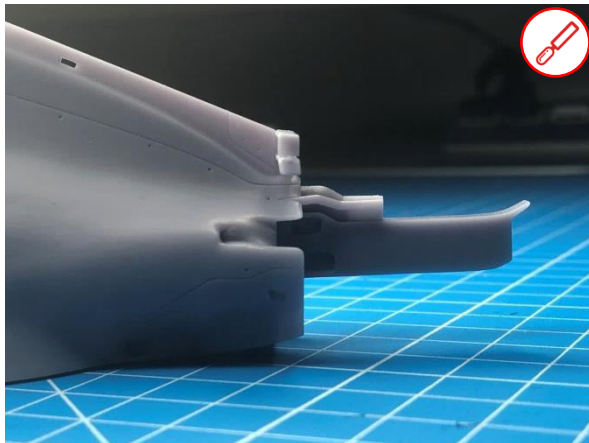

16

In order to be able to assemble the harness buckle, the hole may have to be slightly drilled with a drill $\varnothing 1.8-1.9\text{mm}$. A 4.5mm long nickel silver rod $\varnothing 0.45\text{mm}$ (2x) must be cut for the adjusters. Different lengths of satin ribbon must be cut for the seat belts. Width: 3mm - 6x 30mm long, width: 2mm - 2x 25mm long. Either an opening has to be drilled in the seat for the loops or they are led up in front of the seat.

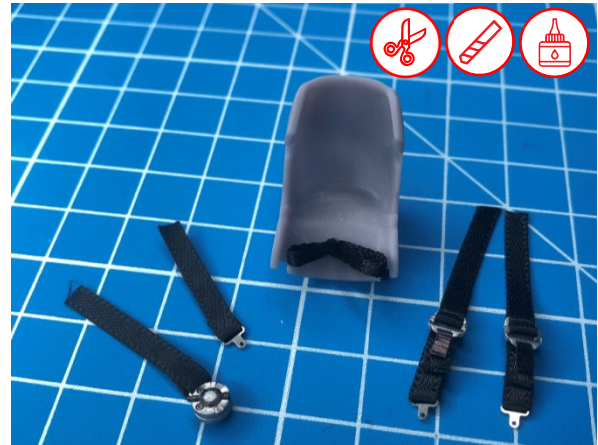
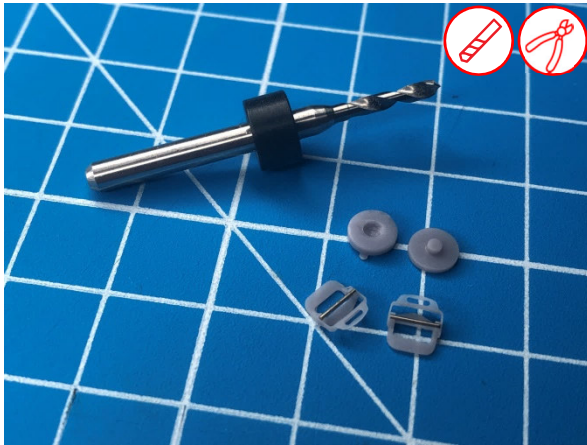

17

In order to be able to join the parts, the holes in the base plate may have to be opened. When assembling, make sure that the unscathed surface of the base plate is on top. The slot in the holder may also have to be widened a little. The best way to do this is to use an engraving blade (0.15-0.2mm). Gluing of all 3 parts is recommended before painting.

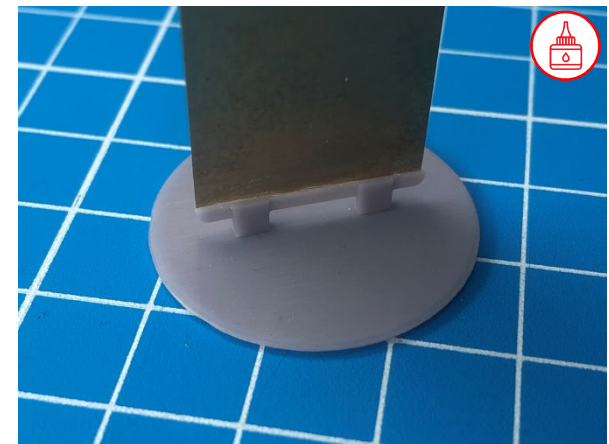

18

Before painting all the components, make sure to test the accuracy of fit of all add-on parts again.

⚠ Attention: There should always be a certain space between the components so that, depending on the paint application during painting, the accuracy of fit is still guaranteed afterwards

! Note: This instruction is also available as a PDF file under the following link:
<https://flstone.com/downloads>



Explanation of symbols:



Use a scissors



Use a file or sandpaper



Use a knife or scalpel



Drill



Glue



Use a side cutter



Do not use a knife or side cutter

Special Thanks to SAURO TORREGGIANI for letting me use his illustrations.
Support him on <http://www.patreon.com/saurotorreggiani>

