

# Messerschmitt Bf 109E-1

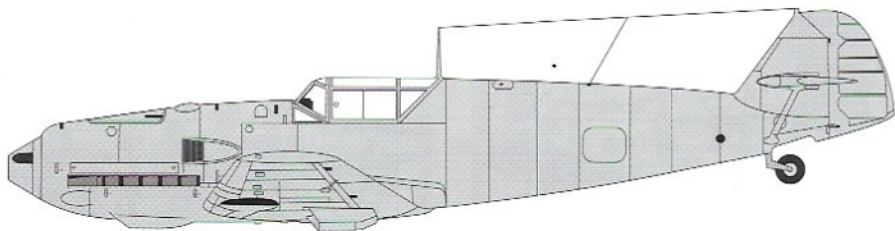

### History in brief

The Messerschmitt Bf 109, often called Me 109 (most often by Allied pilots and aircrew), was a German World War II fighter aircraft designed by Willy Messerschmitt and Robert Lusser during the early to mid-1930s. It was one of the first truly modern fighters of the era, including such features as all-metal monocoque construction, a closed canopy, a retractable landing gear, and was powered by a liquid-cooled, inverted-V12 aero engine.

The Bf 109 first saw operational service during the Spanish Civil War and was still in service at the dawn of the jet age at the end of World War II, during which time it was the backbone of the Luftwaffe's fighter force. From the end of 1941 the Bf 109 was supplemented by the Focke-Wulf Fw 190. Originally conceived as an interceptor, later models were developed to fulfill multiple tasks, serving as bomber escort, fighter-bomber, day-, night-, all-weather fighter, ground-attack aircraft, and as reconnaissance aircraft. It was supplied to and operated by several states during World War II, and served with several countries for many years after the war. The Bf 109 was the most produced fighter aircraft in history, with a total of 33,984 airframes produced from 1936 up to April 1945.

The Bf 109 was flown by the three top-scoring German fighter aces of World War II, who claimed 928 victories among them while flying with Jagdgeschwader 52, mainly on the Eastern Front, as well as by Hans-Joachim Marseille, the highest scoring German ace in the North African Campaign. It was also flown by several other aces from Germany's allies, notably Finn Ilmari Juutilainen, the highest scoring non-German ace on the type with 58 victories flying the Bf 109G, and pilots from Italy, Romania, Croatia, Bulgaria and Hungary. Through constant development, the Bf 109 remained competitive with the latest Allied fighter aircraft until the end of the war.

### Read before you start:

- 1/ Before you begin, study carefully instructions, exploded drawings and numbering of parts.
- 2/ Prior your assembly, choose carefully your variant and remove all parts of it.
- 3/ Optional parts and theirs application compare with the picture on the box.
- 4/ Carefully remove parts, clean its and prior to applying adhesive, check to see whether the parts fit together.
- 5/ Assemble thoroughly, do not hurry. You will find that your finished model will reflect your time, work and patience.

### Symbols

Drill hole



Cyanoacrylate



Remove



Reduce



Make new



Option



Bend



Putty



Colour name	Humbrol	Colour name	Humbrol
<b>A</b> RLM 22 Black	H33	<b>G</b> Aluminium	H56
<b>B</b> RLM 21 White	H34	<b>H</b> RAL 01 Silver	H11
<b>C</b> RLM 66 Black Grey	H67	<b>I</b> RLM 24 Blue	H25
<b>D</b> Gunmetal	H53	<b>J</b> RLM 23 Red	H60
<b>E</b> RLM 70 BlackGreen	H241	<b>K</b> RLM 02 Grey	H240
<b>F</b> RLM 04 Yellow	H24	<b>L</b> RLM 26 Brown	H113

Visit our e-shop at  
[eshop.kovozavody.cz](http://eshop.kovozavody.cz)  
 and make your purchase safe

# Plastic parts/Plastikové díly

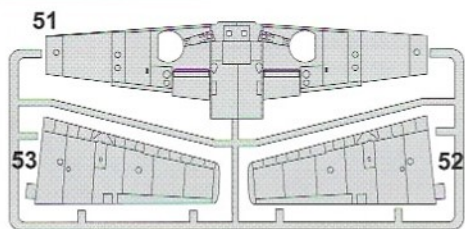
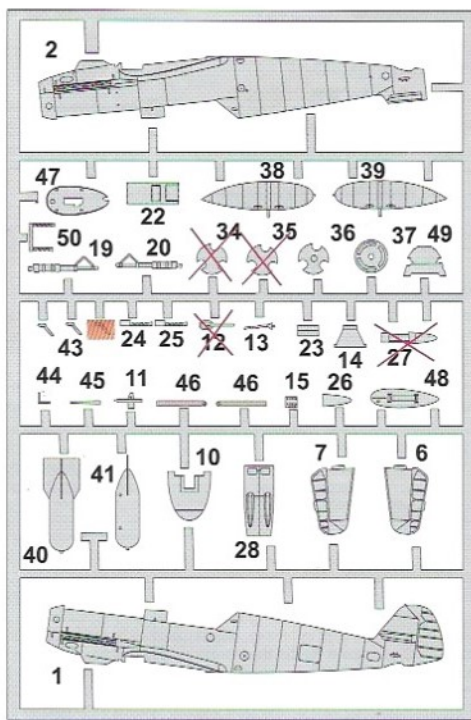
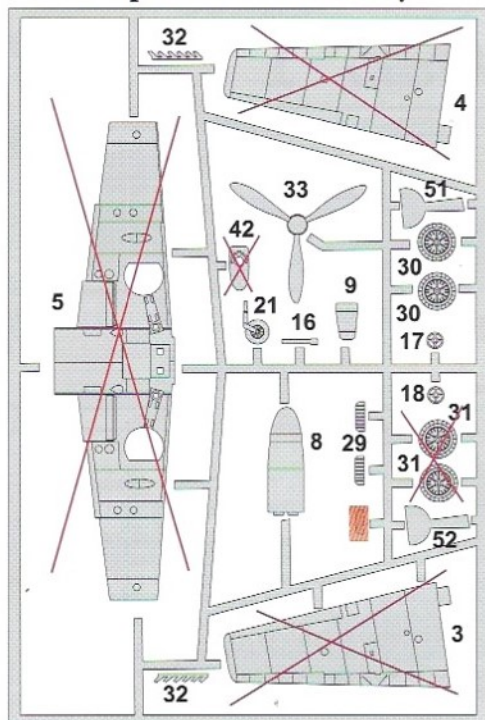

## Clear parts

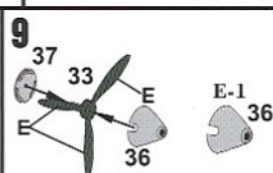
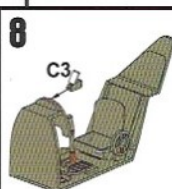
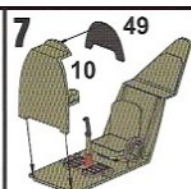
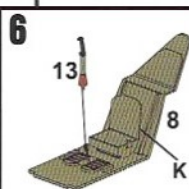
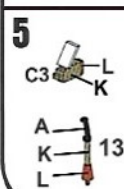
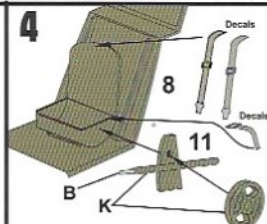
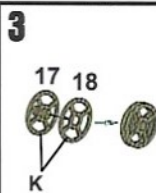
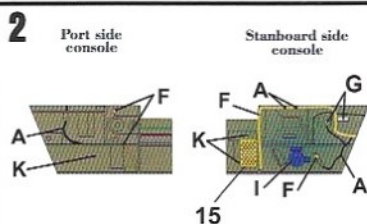
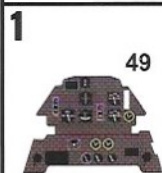
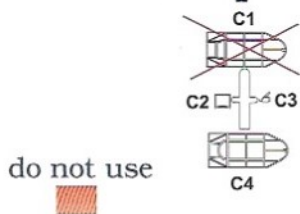



10

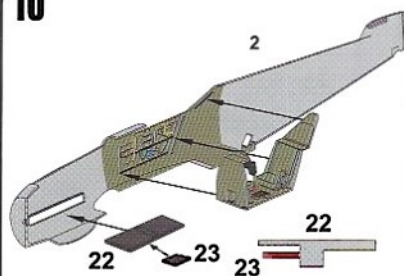

11

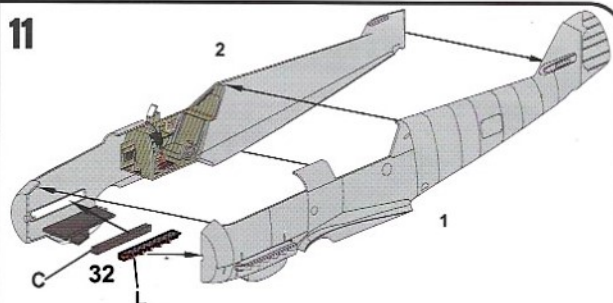

12

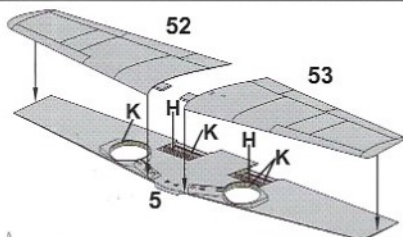
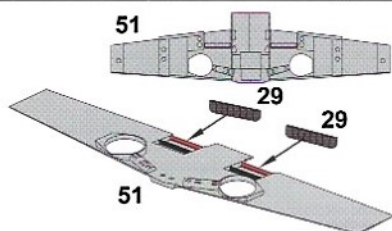

13

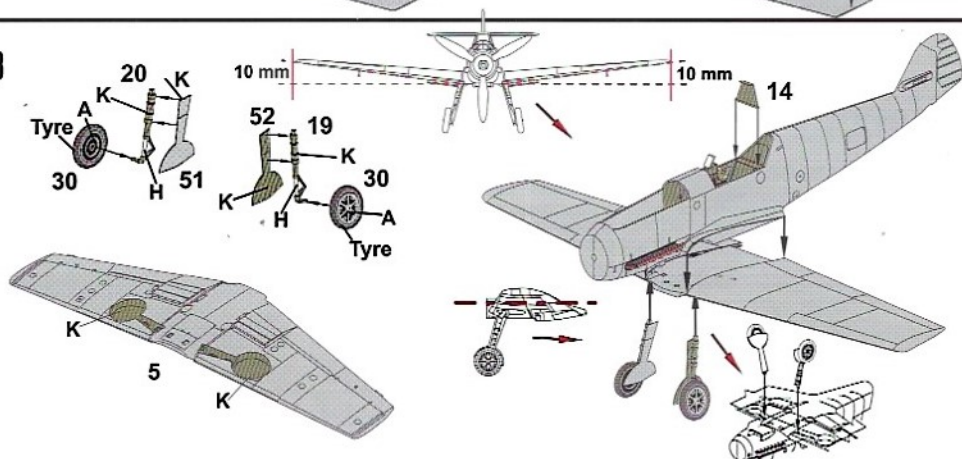

14

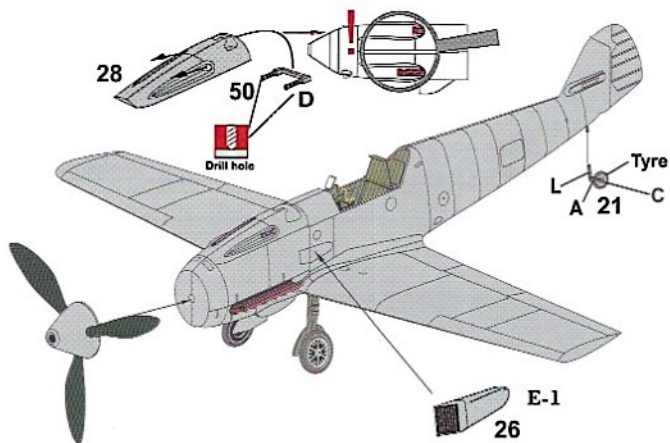

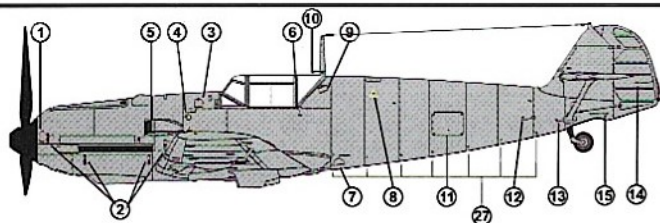
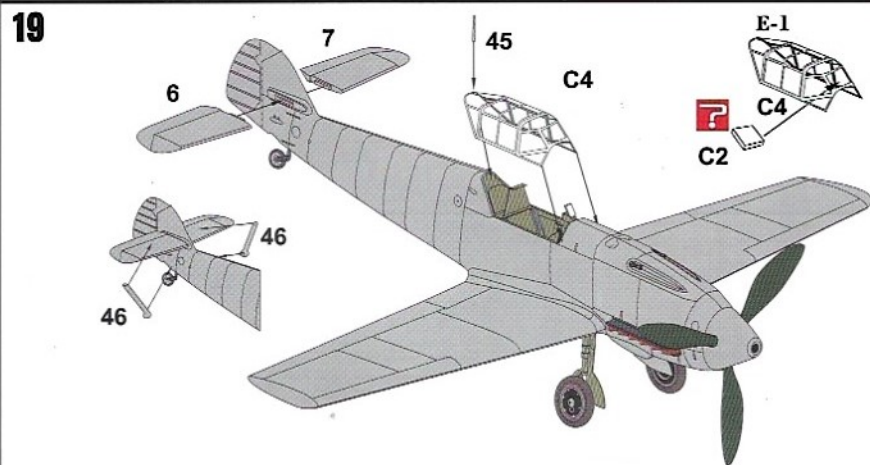
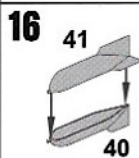
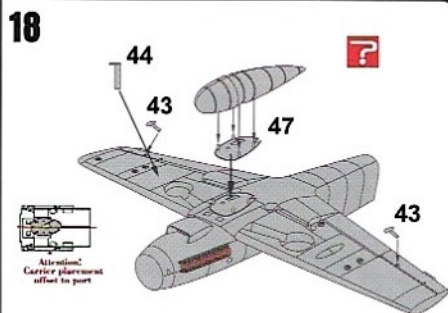
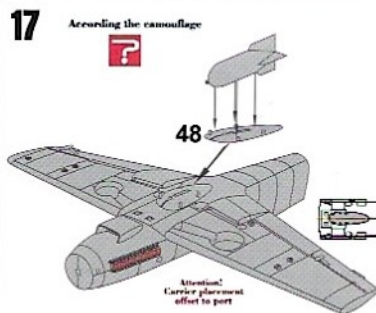
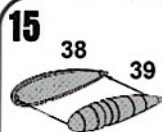

## Technical stencils

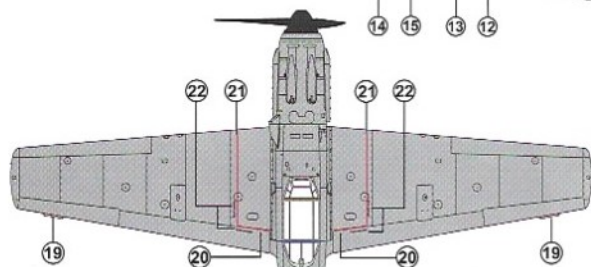
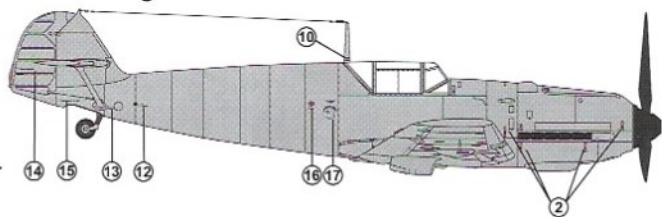



### Colours & Markings

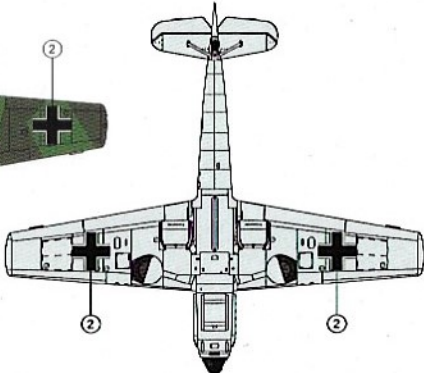
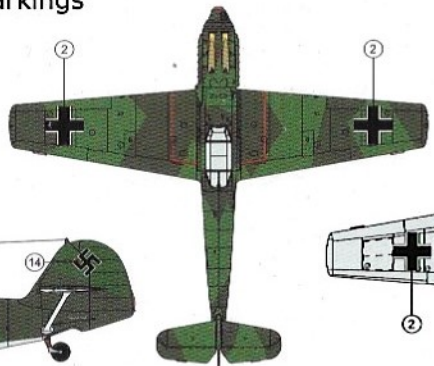
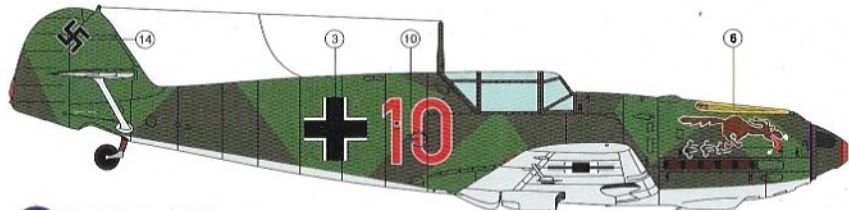

**1** Bf 109E-1 2./JGr 101  
Poland, September 1939

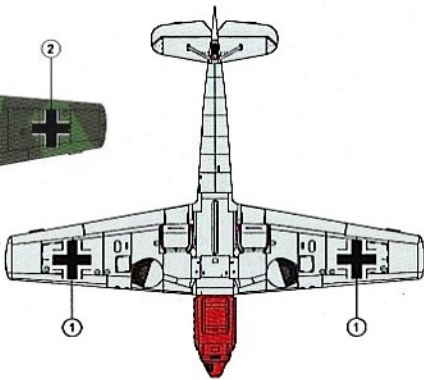
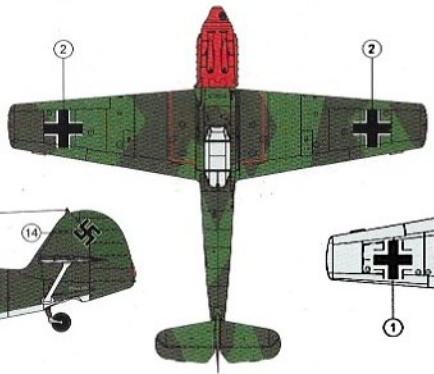
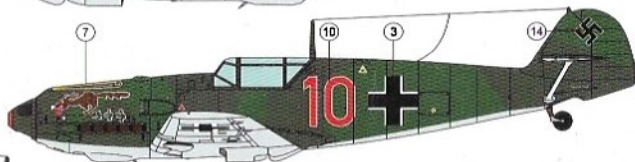

**2** Bf 109E-1, 2.(J)/LG2, "Peter"  
Poland, September 1939

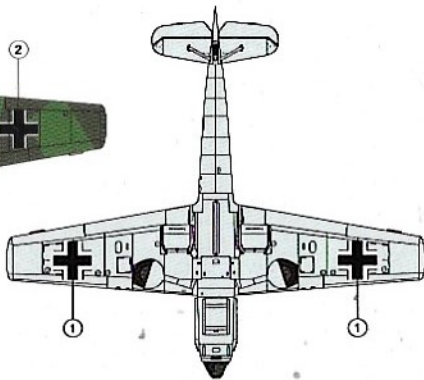
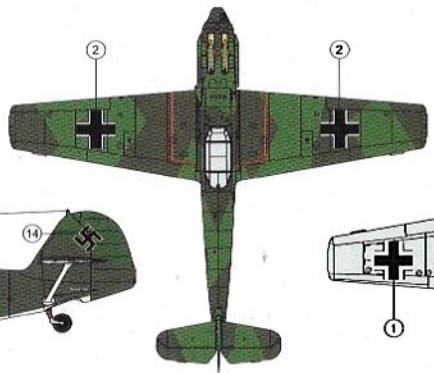
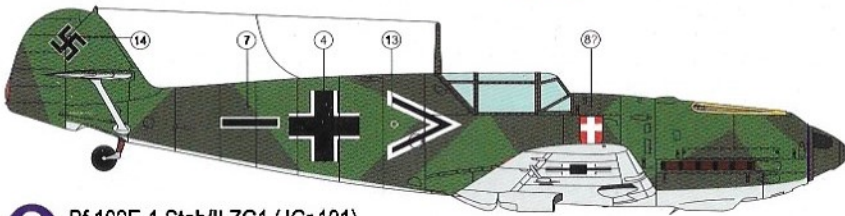
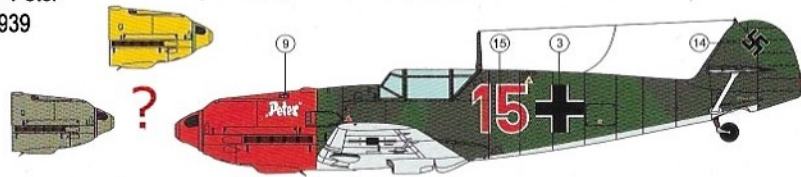

**3** Bf 109E-1 Stab/II.ZG1 (JGr.101)  
Erwin Bacsla  
Furstenwalde/Danzig (Gdańsk), Poland 1939

RLM 71 Green	RLM 70 Blackgreen	RLM 65 Light Blue	RLM 02 Light Grey	RLM 04 Yellow	RLM 23 Red

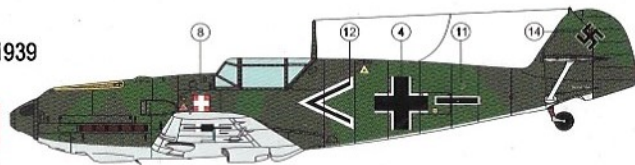



**AZmodel**  
Plastic kits

UNASSEMBLED PLASTIC MODEL KIT.  
CEMENT AND PAINT NOT INCLUDED.

**Box contains:** Plastic parts by HQT  
Decal sheet for 3 versions  
Colour instructions

New Tool  
2021



carlos  
alonso  
2021

**1:72** SCALE MODEL KIT  
No. AZ 7801

Messerschmitt **Bf 109E-1** "Polish Campaign"