

4116-3800

Stearman Aircraft, a subsidiary of Boeing, designed and developed the "Kaydet" series airplanes during the 1930's. Originally, they were designed and used as training planes for both the Army and the Navy. This plane was the last biplane employed by the armed forces. More "Kaydets" were manufactured, over 10,000 between 1936 and the end of World War II, than any other biplane.

The main difference in the several types of Kaydets were in the engines used. This particular replica was powered by a 215 hp Lycoming and also had an

improved electrical system.

Many Kaydets were put into use after the war as crop dusters as well as, in air shows.

BOEING PT-13D KAYDET SPECIFICATIONS:

WINGSPAN	32'
LENGTH	25' 1/4"
HEIGHT	9' 8"
ENGINE	215 HP LYCOMING
PERFORMANCE	RANGE 440 MILES
	SERVICE CEILING 11,700'

ENGLISH: ASSEMBLY DRAWINGS SHOULD BE REVIEWED BEFORE PROCEEDING WITH CONSTRUCTION. A NUMBER IDENTIFIES EACH PLASTIC PART FOR YOUR CONVENIENCE. PAINT SMALL PARTS ON RUNNER BEFORE REMOVING. ALLOW PAINT TO DRY THOROUGHLY BEFORE CONTINUING ASSEMBLY OF KIT. SCRAPE CHROME OR PAINT AT AREA TO BE GLUED. WASH PLASTIC IN MILD DETERGENT SOLUTION. RINSE AND LET AIR DRY FOR BETTER PAINT AND DECAL ADHESION.

DEUTSCH: VOR DEM ZUSAMMENBAU DIE BAUANLEITUNG GUT DURCHLESEN. JEDES TEIL IST NUMMIERT. KLEINE TEILE ANSTREICHEN BEVOR SIE VOM RAHMEN ENTFERNT WERDEN. FARBEN GUT TROPFEN, ERST DANN MIT DER ZUSAMMENSTELLUNG FORTSETZEN. CHROM UND FARBE AN DEN KLEBEFLÄCHEN ENTFERNEN. PLASTIKTEILE IN EINER MILDEN WASCHMITTELLOSUNG REINIGEN UND AN DER LUFT TROCKNEN. DAMIT FARBE UND ABZIEHBILDER BESSER HAFTEN.

FRANCAIS: EXAMINER LES SCHEMAS D'ASSEMBLAGE AVANT DE COMMENCER LA CONSTRUCTION. UN NUMERO IDENTIFIE CHAQUE PIECE DE PLASTIQUE POUR PLUS DE FACILITE. PEINDRE LES PETITES PEICES SUR LE SUPPORT AVANT DE LES ENLEVER. LAISSER LA PEINTURE SECHER COMPLETEMENT AVANT DE CONTINUER L'ASSEMBLAGE DU KIT. GRATTER LE CHROME OU LA PEINTURE SUR LES SURFACE A COLLER. LAVER LE PLASTIQUE DANS UNE SOLUTION DE DETERGENT LEGERE, RINCER ET LAISSER SECHER A L'AIR POUR UNE MEILLEURE ADHERENCE DE LA PEINTURE ET DES DECALS.

NEDERLANDS: BESTUDER DE MONTAGE TEKENINGEN, VOORDAT U MET BOUWEN BEGINT. VOOR UW GEMAK, IDENTIFICEERT EEN NUMMER ELK PLASTIC DEEL. VERF KLEINE DEELTJES OP KIBOOM VOORDAT U ZE VERWYDERD. LAAT VERF GRONDIG DROGEN VOORDAT U DE MONTAGE VAN HET MODEL VOORTZET. SCHRAP CHROOM OF VERF VAN HET GEDEELTE DAT GELYMD WORDT. WAS PLASTIC MET EEN ZACHTE ZEEP, SPOEL AF, EN LAAT IN LUCHT DROGEN, ZODAT VERF EN DECAL BETER PLAKKEN.

SVENSKA: IHOPSÄTTNINGSSKISSEN BÖR GRANSKAS INNAN IGANGSÄTTANDE AV BYGGANDET. ETT NUMMER IDENTIFIKERAS VARJE PLASTDEL FÖR DIN EGNA BEKVÄMLIGHET. MALA DE SMA BITARNA DIREKT PÅ FARAN INNAN DE TAS BORT. LÅT FÄRGEN TORKA GRUNDLIGT INNAN FORTSÄTT BYGGANDE. SKRAPA AV KROMEN ELLER MALA PÅ DELARNA SOM SKALL KLISTRAS. TVÄTTA PLASTEN I MILD TVÄTTMEDLÖSNING, SKOJ OCH LUFTTORKA FÖR BÄTTRE FASTANDE AV FÄRG OCH DEKALER.

ESPAÑOL: DIBUJOS DE ENSAMBLAJE DEBEN SER REPASADOS ANTES DE SEGUIR CON LA CONSTRUCCION. UN NUMERO IDENTIFICA CADA PARTE DEL PLASTICO PARA SU CONVENIENCIA. PINTA PARTES PEQUEÑAS DEL KIT ANTES DE QUITARLAS. DEJE SECAR BIEN LA PINTURA ANTES DE SEGUIR EL ENSAMBLAJE. RASPE EL CROMO O LA PINTURA DEL SITIO ANTES DE SER PEGADO. LAVE EL PLASTICO EN UNA SOLUCION SUAVE DETERGENTE, ENJUAGUE, Y DEJE SECAR EN EL AIRE PARA MEJOR ADHESION DE LA PINTURA Y CALCOMANIA.

ITALIANO: I DISEGNI DELL'ASSEMBLAGGIO DOVREBBERO ESSERE RICONTROLLATI PRIMA DI INIZIARE IL MONTAGGIO. OGNI PEZZO È IDENTIFICATO DA UN NUMERO PER VOSTRA MAGGIORE COMODITÀ. VERNICIARE LE PARTI PICCOLE SULLA GUIDA DE SCORRIMENTO PRIMA DI TOGLIERLE. LASCIAR ASCIUGARE LA VERNICE PRIMA DI CONTINUARE IL MONTAGGIO. RASCHIAR LA PITTURA O IL CROMO DALLE PARTI CHE DEVONO ESSERE INCOLLATE. LAVARE I PEZZI DI PLASTICA CON UN DETERGENTE NON TROPPO FORTE, SCIAQUARE E LASCIAR ASCIUGARE AFFINCHÉ VERNICE E DECALOMANIE ADERISCONO MEGLIO.



GLUE
KLEBER
COLLE
LIJM
KLISTER
PEGA
COLLA



NO GLUE REQUIRED
KEIN KLEBER NOTWENDIG
LA COLLE N'EST PAS NECESSAIRE
GEEN LIJM NODIG
INGET KLISTER BEHOVS
NO NECESITA PEGA
NON C'E BISOGNO DI COLLA



DO IT THIS MANY TIMES
ANZAHL DER ARBEITSGRENZE
LE FAIRE CE NOMBRE DE FOIS
DOE HET ZOVEEL KEER
GJOR DET SA MANGA GANGER
FATELO TUTTE QUESTA VOLTE
HAGALO ESTA CANTIDAD DE VECES



OPTIONAL
WAHLWEISE
FACULTATIF
NAAR KEUZE
VALFRI
FACOLTATIVO
OPCIONAL



APPLY DECALS
ABZIEHBILDER ANBRINGEN
COLLER LES DECALOMANIES
BRENG PLAKPLAATJES AAN
SATT PA DEKALERNA
APPLICARE LE DECALOMANIE (ADESIVI)
APLICAR CALCAS



SHOWN ASSEMBLED
ABBILDUNG DES ZUSAMMEN GEBAUTEN MODELLS
VU ASSEMBLE
GEMonteerd GETOOND
VISAD IHOPSÄTTNING
MOSTRADO ARMADO
ILLUSTRAZIONE DEL PEZZO MONTATO



CLEAR
KLAR
TRANSPARENT
DOORZICHTIG
KLART
VIA LEBERA
TRANSPARENTE



YELLOW
GELB
JAUME
GEEL
GUL
AMARILLO
GIALLO

A	YELLOW	GELB	JAUME	GEEL	GUL	AMARILLO	GIALLO
B	BLUE	BLAU	BLEU	BLAUW	BLA	AZUL	BLU
C	MATT BLACK	MATT SCHWARZ	NOIR MAT	MAT ZWART	MATT SVART	NEGRO MATE	NERO SMORTO
D	BROWN	BRAUN	MARRON	BRUIN	BRUN	MARRON	MARRONE
E	GRAY	GRAU	GRIS	GRIJS	GRA	GRIS	GRIGIO
F	LIGHT OLIVE	OLIV-HELL	OLIVE CLAIR	LICHT OLIJF	LJUS OLIVAGRON	VERDE OLIVO CLARO	VERDE OLIVA CHIARO
G	FLESH	HAUTFARBE	CHAIR	VLEES KLEUR	HUDFARGAD	PIEL	CARNE

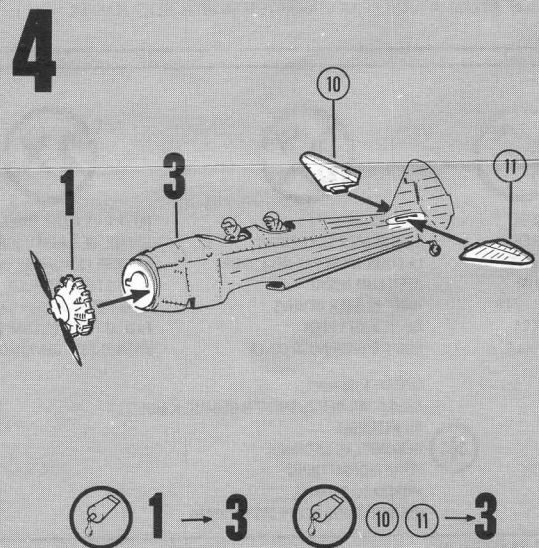
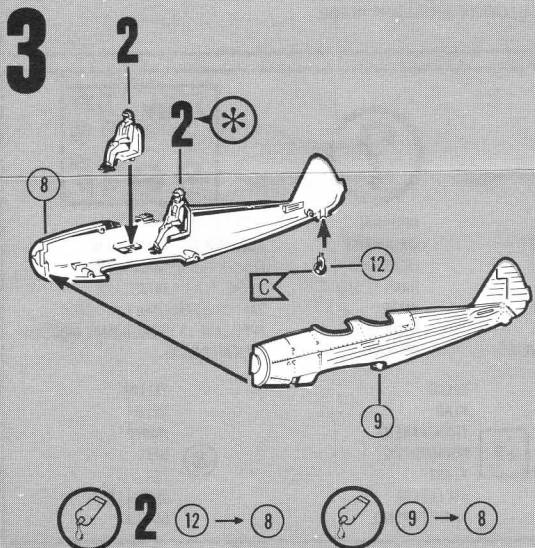
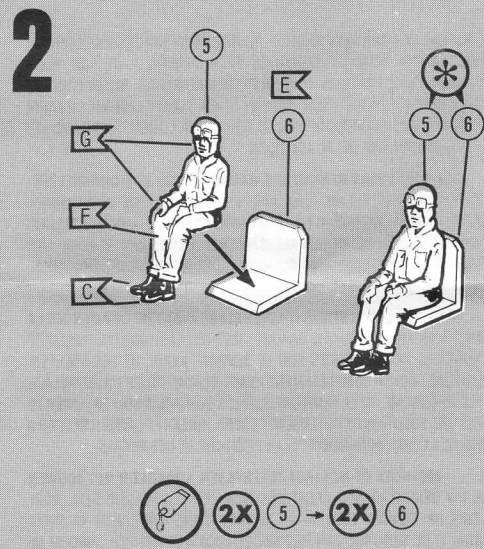
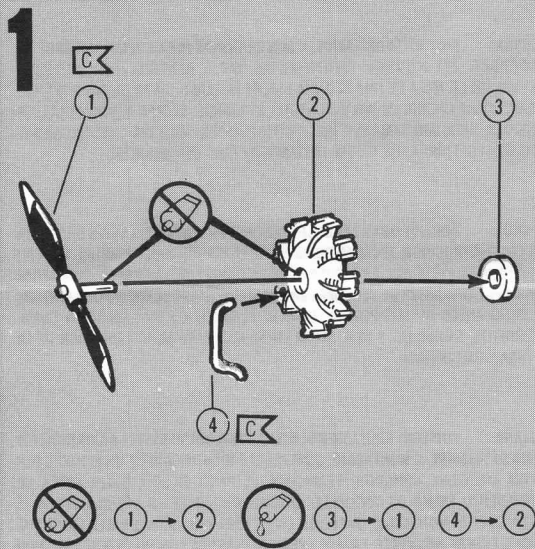
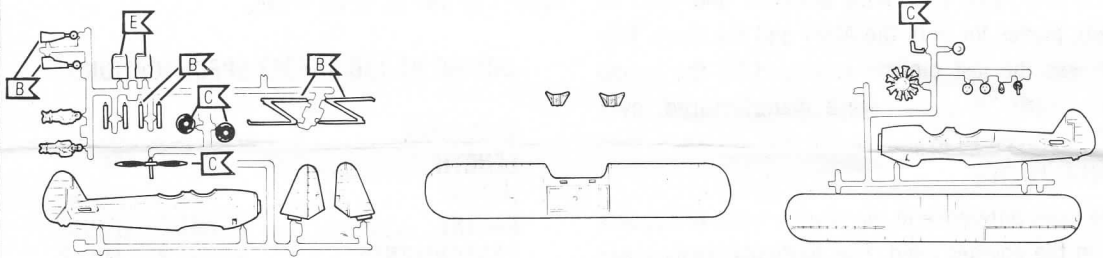

5

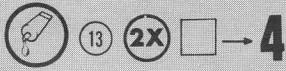
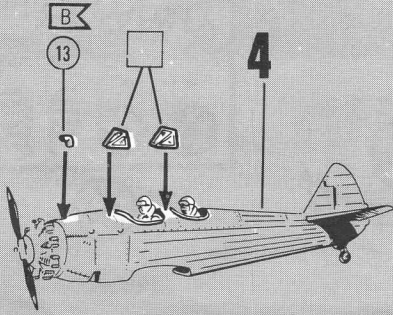

6

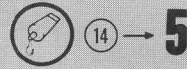
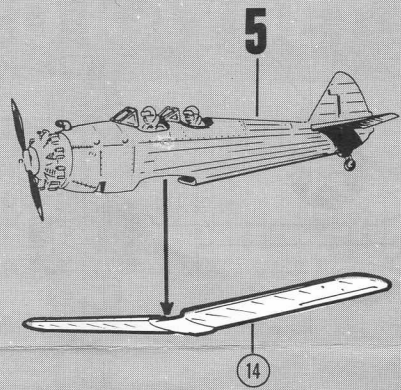

7

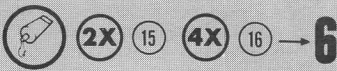
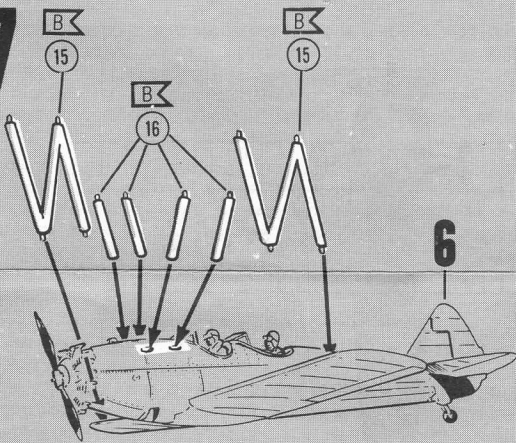

8

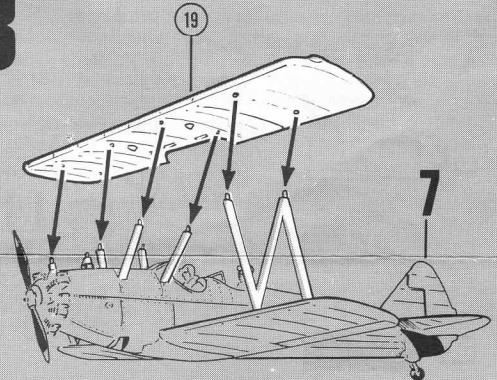

9

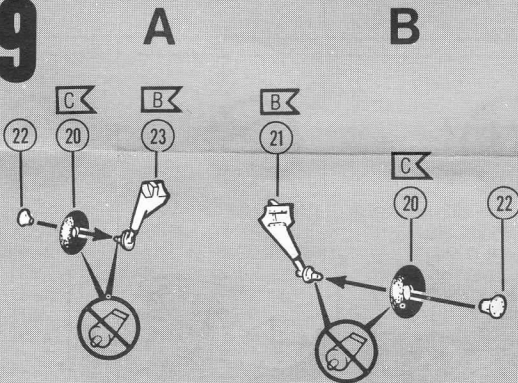

10

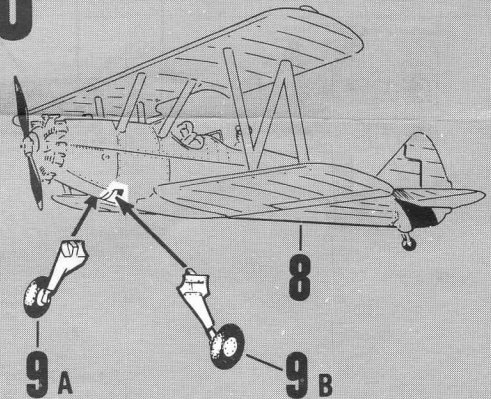

11

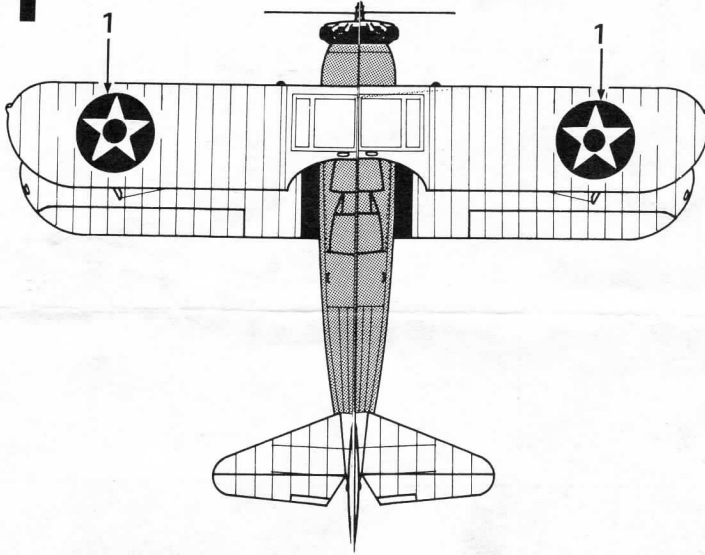

POST SEPT. 1938

ORANGE YELLOW
#506



LIGHT BLUE
#501

