

Heller

UH-72A LAKOTA

80379



DÉCOUVREZ LE MONDE DES PEINTURES ACRYLIQUES HELLER !

DISCOVER THE WORLD OF HELLER ACRYLIC PAINTS!
ENTDECKEN SIE DIE WELT DER HELLER ACRYL-FARBEN!

NEW



- FACILE À UTILISER
- DILUABLE À L'EAU
- POTS DE PEINTURE STABLES
- BOUCHON À VIS SÉCURISÉ

- EASY TO USE
- DILUTABLE WITH WATER
- STABLE PAINT CANS
- SECURE SCREW CAP

- EINFACHE ANWENDUNG
- MIT WASSER VERDÜNNBAR
- STANDFESTE FARBDOSEN
- SICHERER SCHRAUBVERSCHLUSS

Français

L'UH145 (version militarisée de l'EC 145 d'EUROCOPTER) a été sélectionné par l'US Army pour son programme d'équipement LUH (Light Utility Helicopter). Le contrat porte sur la fourniture de 352 appareils. L'UH145 remplacera les UH1H Huey et les OH58 Kiowa.

C'est le lundi 11 décembre 2006 que le premier UH-145 a été livré à l'US Army. Traditionnellement cette dernière donne à ses hélicoptères le nom d'une tribu indienne. Le nouvel appareil, dont la désignation militaire est UH-72A, a été baptisé "Lakota" du nom d'une tribu du peuple Sioux.

L'EC 145 est un hélicoptère bi-moteur multi-usages appartenant à la classe des 3-4 tonnes pouvant compter jusqu'à 10 sièges pour le(s) pilote(s) et les passagers.

English

The UH 145 (military version of EUROCOPTER'S EC 145) has been selected by the US Army for LUH (Light Utility Helicopter) equipment programme. The contract will supply 352 aircraft. The UH145 will replace the UH1H Huey and the OH58 Kiowa.

The first UH-145 was delivered to the US Army on Monday 11th December 2006. Traditionally they name their helicopters after Indian tribes. The new aircraft, whose military designation is UH-72A, was named "Lakota" after a Sioux tribe.

The EC 145 is a twin-engine multi-purpose helicopter belonging to the 3-4 tonne class, and is able to accommodate up to 10 seats for the pilot(s) and passengers.

Deutsch

Der UH 145 (die militärische Version der EUROCOPTER EC 145) wurde von der US Army für das LUH (Light Utility Helicopter)-Programm ausgewählt. Der Vertrag sah die Lieferung von 352 Maschinen vor. Der UH-145 sollte den UH1H Huey und den OH58 Kiowa ersetzen.

Der erste UH-145 wurde am Montag, den 11. Dezember 2006 an die US Army ausgeliefert. Diese benennt ihre Hubschrauber traditionell nach indianischen Stämmen. Die neue Maschine mit der militärischen Bezeichnung UH-72A wurde nach einem Sioux-Stamm "Lakota" benannt.

Der EC 145 ist ein zweimotoriger Mehrzweckhubschrauber der 3- bis 4-Tonnen-Klasse mit bis zu 10 Sitzplätzen für Pilot(en) und Passagiere.

Español

El UH145 (versión militarizada del EC145 de EUROCOPTER), ha sido seleccionado por la US Army para su programa de equipamiento LUH (Light Utility Helicopter). El contrato tiene por objeto el suministro de 352 aparatos. El UH145 reemplazará a los UH1H Huey y a los OH58 Kiowa. Fue el lunes 11 de diciembre de 2006 cuando se entregó el primer UH-145 a la US Army. Tradicionalmente la US Army da a sus helicópteros el nombre de tribus indias. El nuevo aparato, cuya designación militar es UH-72A, ha sido bautizado "Lakota", nombre de una tribu del pueblo Sioux.

El EC 145 es un helicóptero bimotor multi usos que pertenece a la clase de las 3-4 toneladas y que puede contar hasta con 10 asientos para el/los pilotos y los pasajeros.

Italiano

L'UH145 (versione militare dell'EC 145 di EUROCOPTER) è stato selezionato dall'US Army per il suo programma di equipaggiamento LUH (Light Utility Helicopter). Il contratto verte sulla fornitura di 352 apparecchi. L'UH145 sostituirà gli UH1H Huey e gli OH58 Kiowa.

Lunedì 11 dicembre 2006, il primo UH-145 è stato consegnato all'US Army. Per tradizione quest'ultima dà ai suoi elicotteri il nome di una tribù indiana. Il nuovo apparecchio, designazione militare UH-72A, è stato battezzato "Lakota", nome di una tribù del popolo Sioux.

L'EC 145 è un elicottero bimotore multiuso della classe dei 3-4 tonnellate e può contare fino a 10 posti per il pilota(i) e i passeggeri.

Longueur	13,03 m
Largeur	3,12 m
Hauteur	3,96 m
Envagure	11,00 m
Moteurs	2 turbines Turbomeca ARRIEL 1E2, 550 kW / 748 CV chacun
Vitesse maximale	278 km/h

Length	13.03 m
Width	3.12 m
Height	3.96 m
Wingspan	11.00 m
Engines	2 Turbomeca turbine engines ARRIEL 1E2, 550 kW / 748 CV each
Max. speed	278 km/h

Länge	13,03 m
Breite	3,12 m
Höhe	3,96 m
Spannweite	11,00 m
Motor	2 Turbinen Turbomeca ARRIEL 1E2 von jeweils 550 kW / 748 PS
Höchstgeschwindigkeit	278 km/h

Longitud	13,03 m
Ancho	3,12 m
Altura	3,96 m
Envergadura	11,00 m
Motores	2 turbinas Turbomeca ARRIEL 1E2, 550 kW / 748 CV cada una
Velocidad máxima	278 km/h

Lunghezza	13,03 m
Larghezza	3,12 m
Altezza	3,96 m
Apertura alare	11,00 m
Motori	2 turbine Turbomeca ARRIEL 1E2, 550 kW / 748 CV ognuna
Velocità massima	278 km/h

Nederlands

De UH145 (de militaire versie van de EC 145 EUROCOPTER) is door het Amerikaanse leger geselecteerd voor het LUH-programma (Light Utility Helicopter). Het contract heeft betrekking op de levering van 352 toestellen. De UH145 zal de UH1H Huey en de OH58 Kiowa vervangen.

Op maandag 11 december 2006 wordt de eerste UH-145 geleverd aan het Amerikaanse leger. Traditioneel geven zij hun helikopters de naam van een indiaanse stam. Het nieuwe toestel waarvan de militaire benaming UH-72A is, wordt "Lakota" gedoopt, de naam van een Sioux-stam.























De EC 145 is een tweemotorige helikopter die voor verschillende taken kan worden gebruikt en valt in de klasse van 3-4 ton beschikt over maximaal 10 stoelen voor de pilo(o)t(en) en passagiers.

Lengte	13,03 m
Breedte	3,12 m
Hoogte	3,96 m
Spanwijdte	11,00 m
Motoren	2 turbines Turbomeca ARRIEL 1E2, 550 kW / 748 PK elk
Maximale snelheid	278 km/u

1/72

UH-72A Lakota

80379

 11 Argent metallique Silver Metallic Silber metallisch	 18 Orange brillant Orange Gloss Orange glänzend	 24 Jaune entrainement mat Trainer Yellow Matt Trainergelb matt	 27 Gris mer mat Sea Grey Matt Seegräu matt	 33 Noir mat Black Matt Schwarz matt	 34 Blanc mat White Matt Weiß matt	 40 Gris pale brillant Pale Grey Gloss Blassgrau glänzend	
 49 Vernis mat Varnish Matt Klarlack matt	 53 Gris metallique Gunmetal Metallic Grau metallisch	 56 Aluminium metallique Aluminium Metallic Aluminium metallisch	 61 Chair mat Flesh Matt Hautfarbe matt	 63 Sable mat Sand Matt Sand matt	 77 Bleu marine mat Navy Blue Matt Marineblau matt	 85 Noir de charbon satine Coal Black Satin Kohlenschwarz seidenmatt	 86 Olive clair mat Light Olive Matt Olivgrün hell matt
 127 Gris fantome US satine US Ghost Grey Satin US-Schattengrau seidenmatt	 130 Blanc satine Blanc satine Weiß seidenmatt	 321 Rouge transparent Red Transparent Rot transparent	 325 Vert transparent Green Transparent Grün transparent	 M1 18 + 130	 M2 34 + 40	 M3 18 + 49	

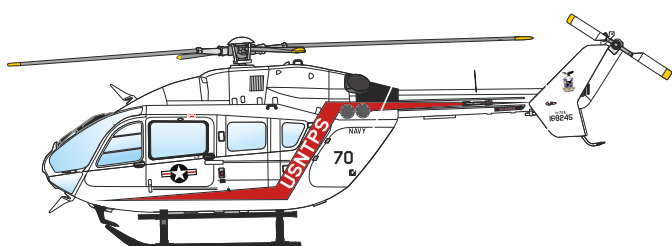

a US Naval Test Pilot School, Patuxent River, Maryland, 2020-2023
No.168245; 168246; 168247; 168248; 168249

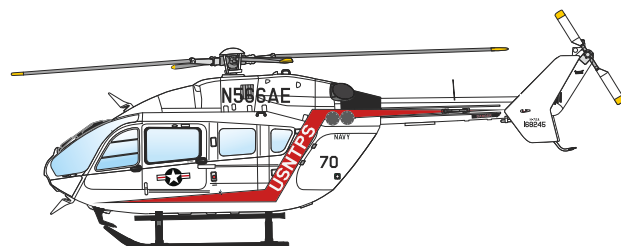

b US Naval Test Pilot School, Patuxent River, Maryland,
N566AE, 2009



c UH-72A "Lakota",
N145UH, Demonstration



d UH-72A "Lakota",
72001, 2007

- Si aucune teinte n'est spécifiée, peindre dans les couleurs de la version choisie. Se reporter aux pages 15 - 18 pour le détail du schéma de peinture.
- When no color is specified, paint the item with colors of chosen version. Refer to pages 15 - 18 for painting pattern.
- Wenn keine Farbe angegeben ist, Teile mit den Farben der gewählten Version bemalen. Beachten Sie die Seiten 15 - 18 für die Lackierung und Markierung.
- Cuando ningún color es especificado, pintarle con los colores del tema de la versión elegida. Vea las páginas 15 - 18 para obtener detalles de pintura.

2

Numéro de phase
Step number
Schrittnummer
Número de fase

56































Référence de couleur
Colour reference no
Farbangabe
Referencia de color

37

Numéro de pièce
Part number
Teilenummer
Número de pieza

6

Numéro de decal
Decal number
Abziehbildnummer
Número de calcomanía

- 
-  27
-  18
-  56
-  77
-  85
-  127
-  130
-  M2
-  62
-  44
-  77
-  56
-  77
-  85
-  31
-  30
-  85
-  77
-  77
-  85
-  27
-  85
-  127
-  77
-  56
-  77
-  85
-  130
-  18
-  47

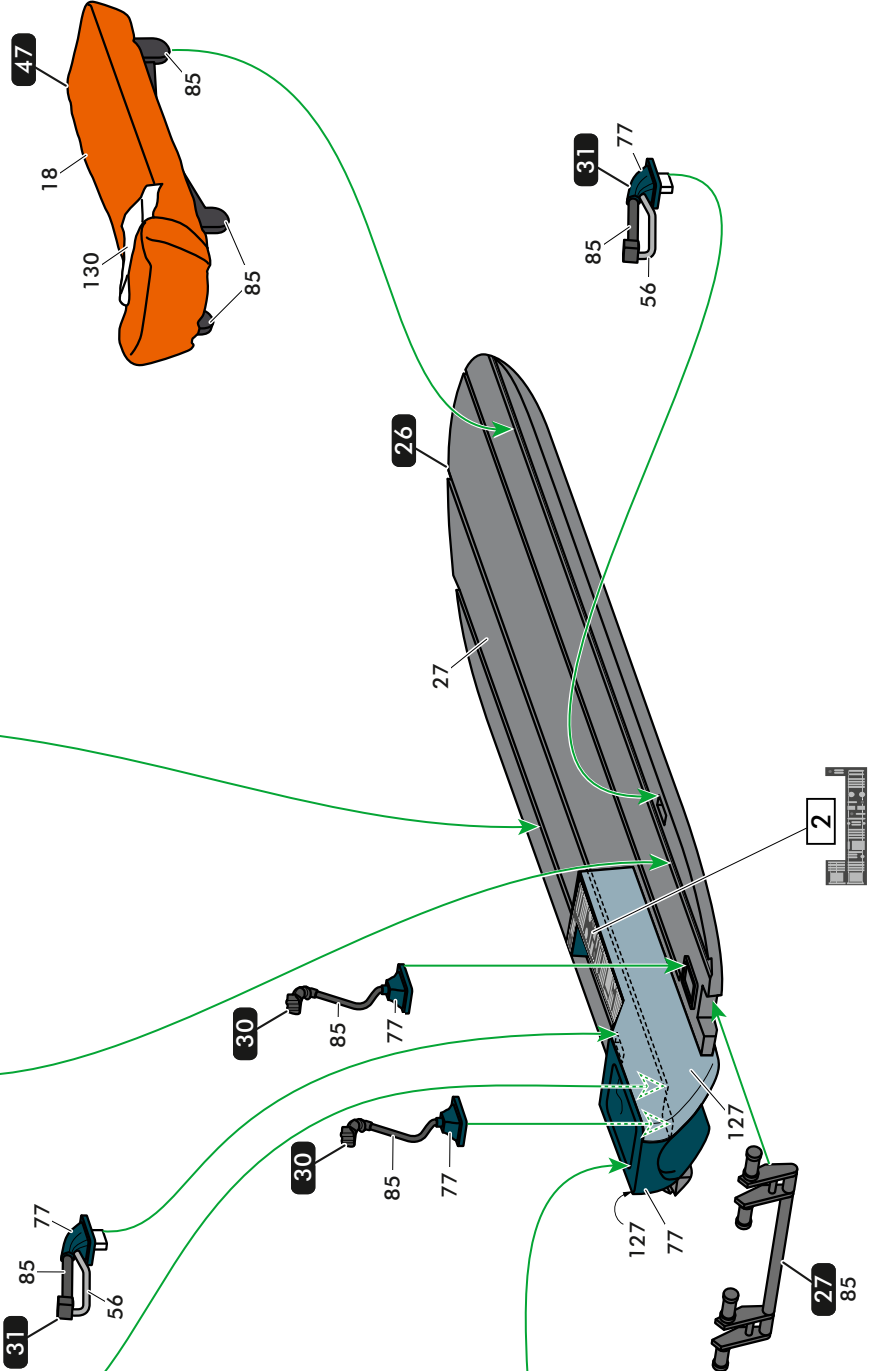
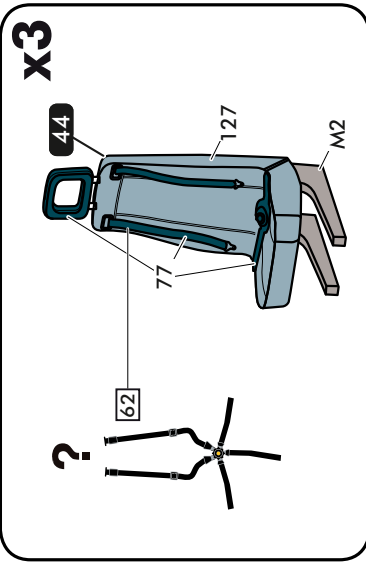
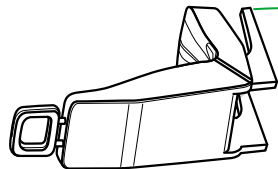
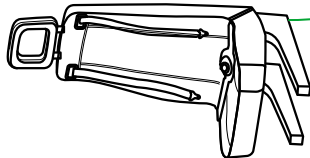
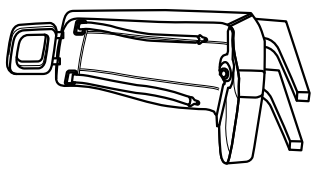
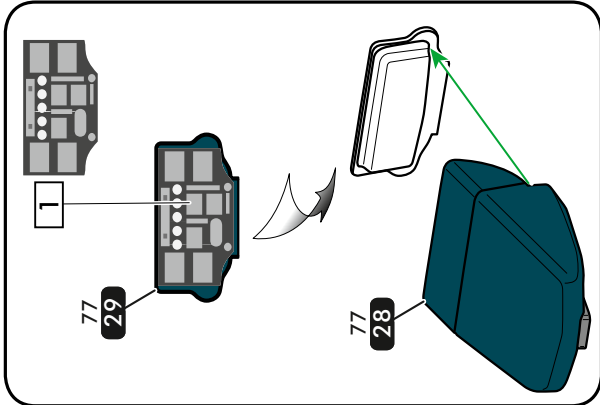



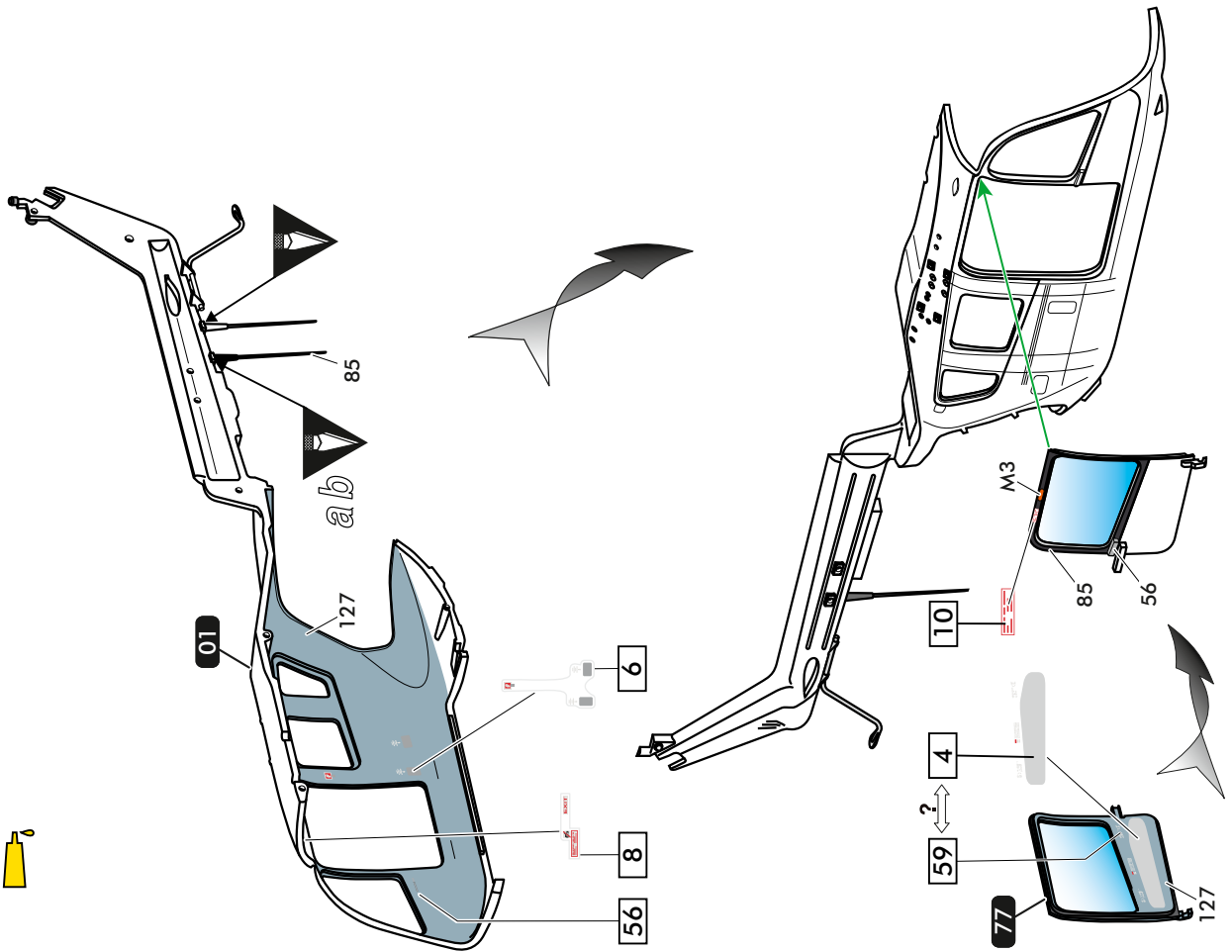
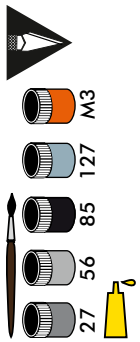

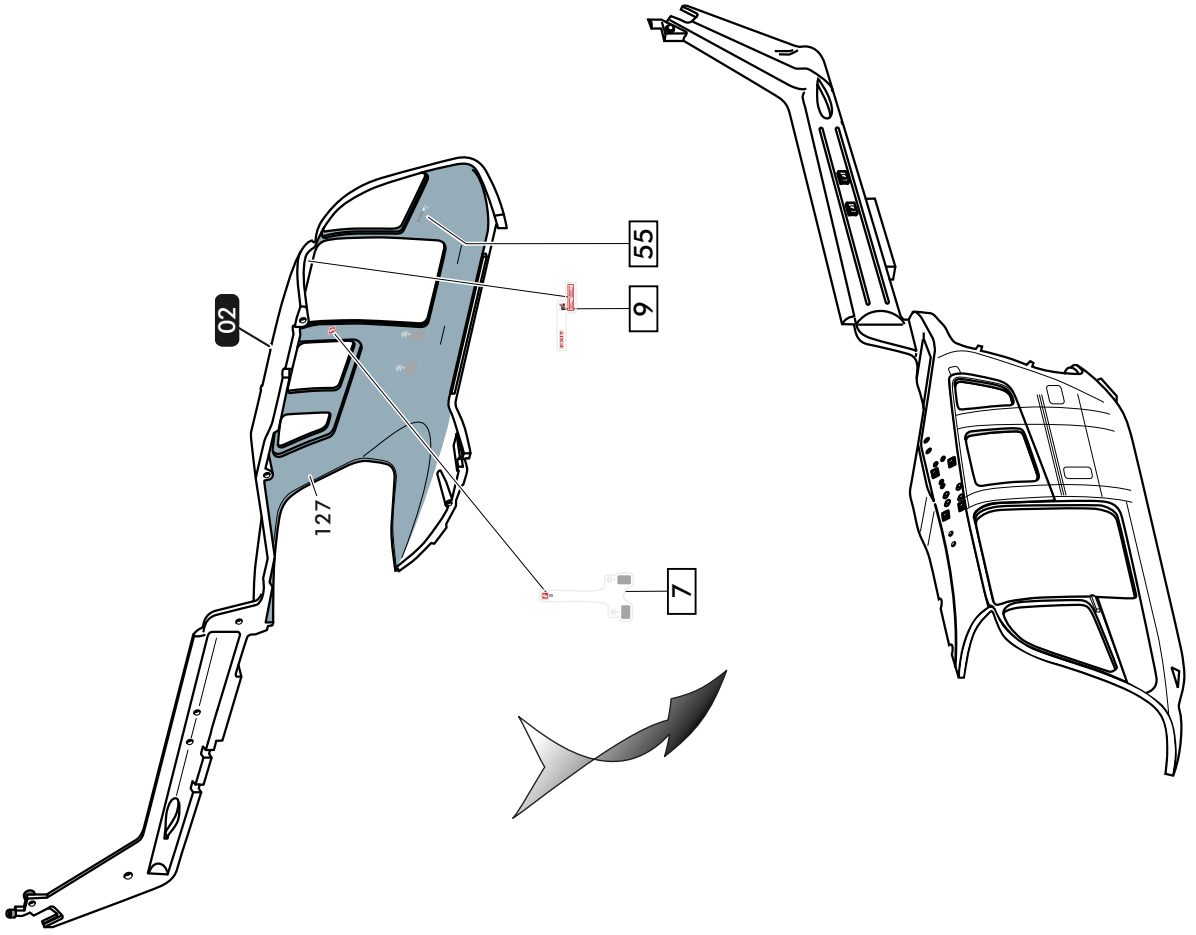

2

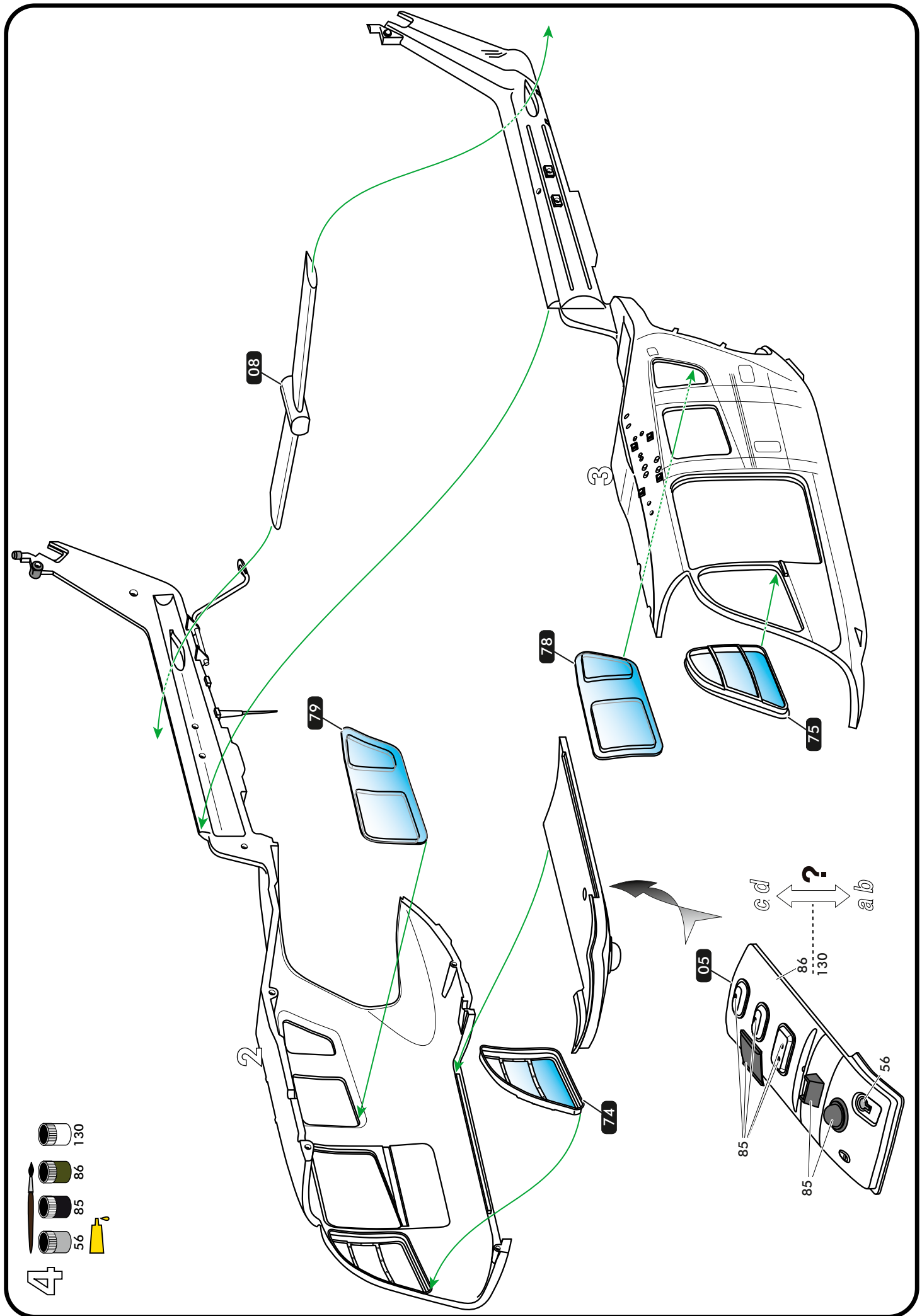

3





-  130
-  86
-  85
-  56
- 

4

5



33



56



85



127



25

a b

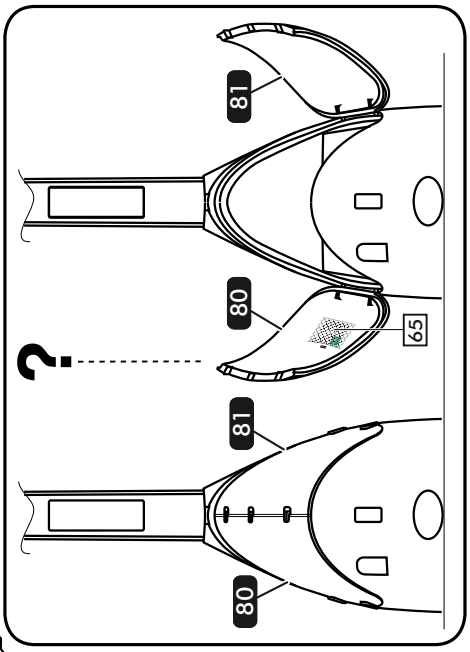
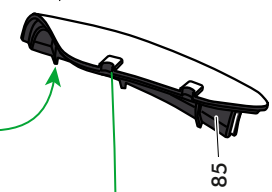
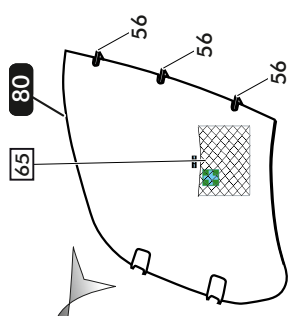
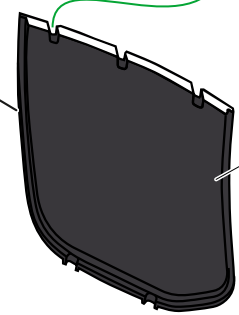
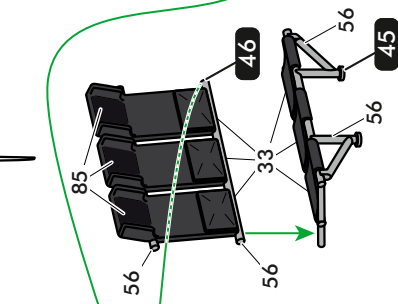
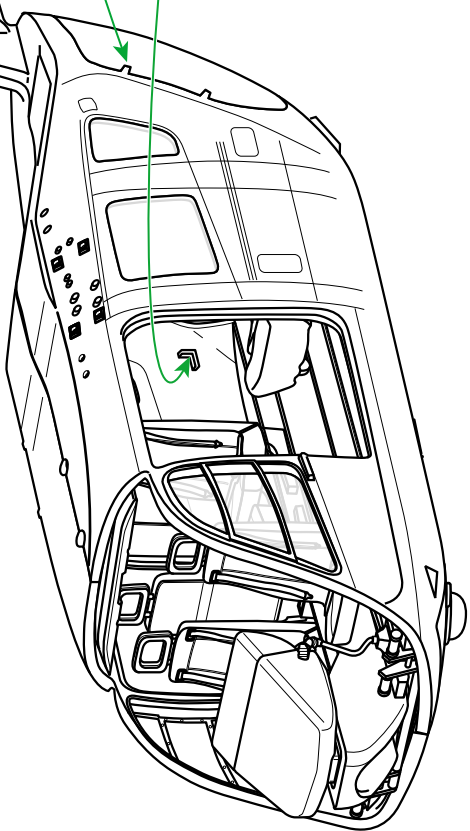
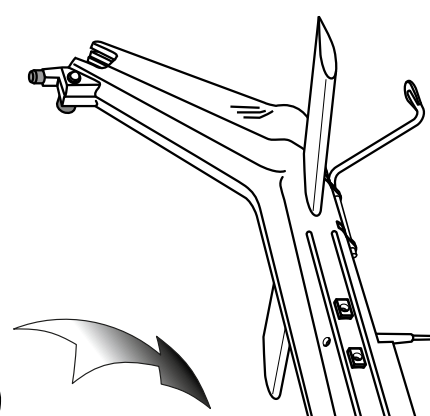
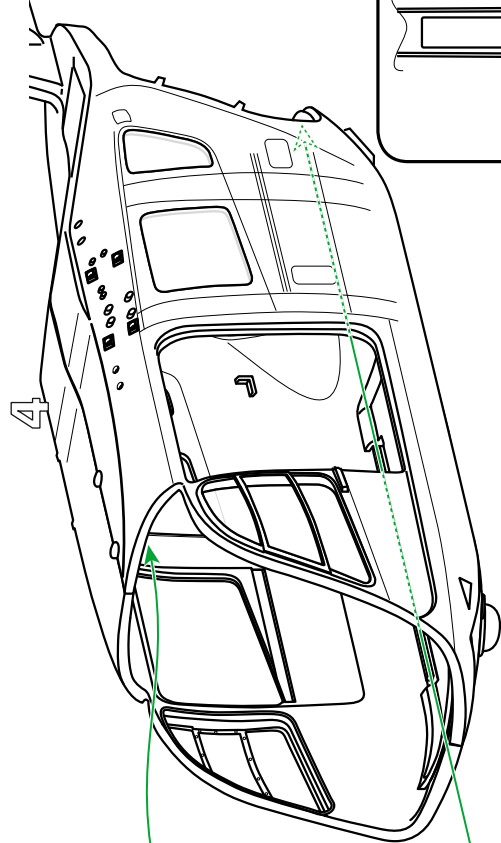
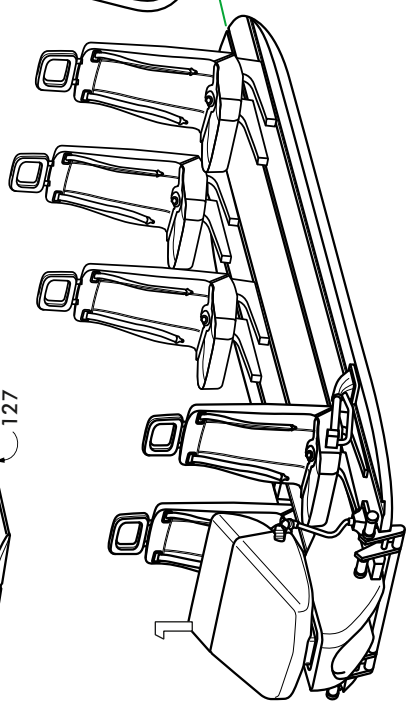
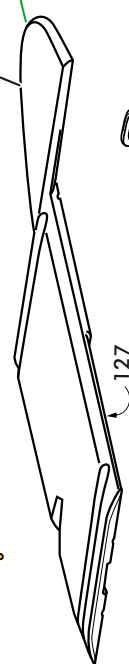

- 5
- 27
- 56
- 63
- 85
- 127
- c
- d

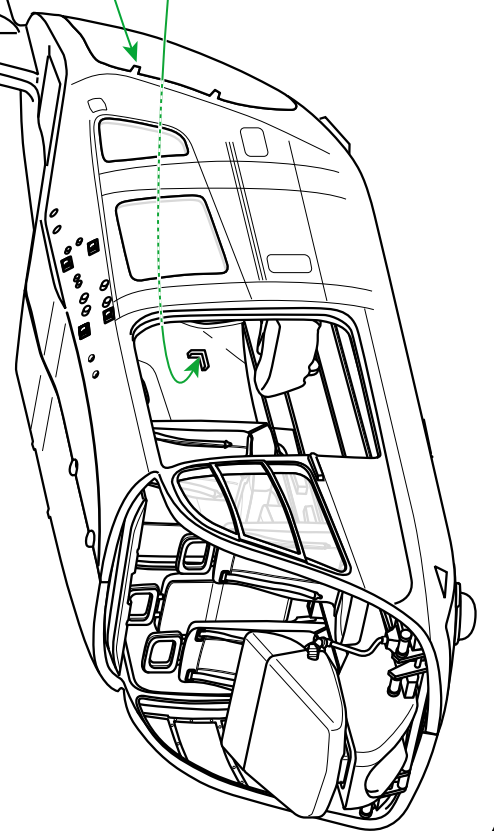
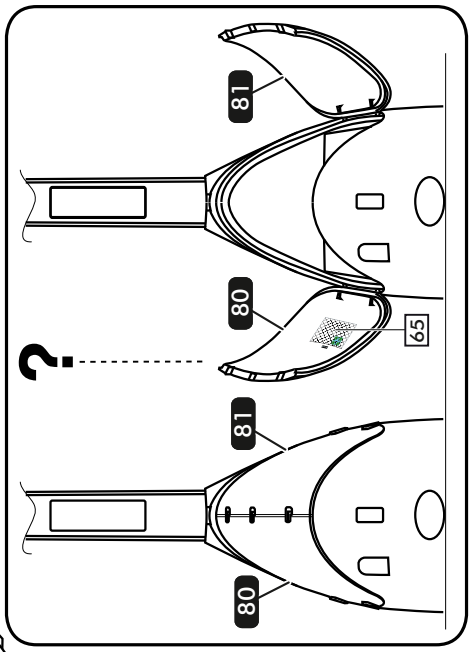
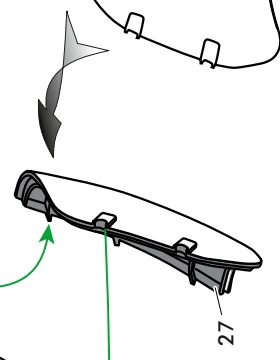
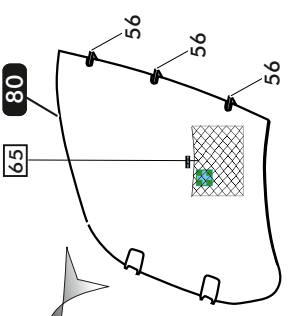
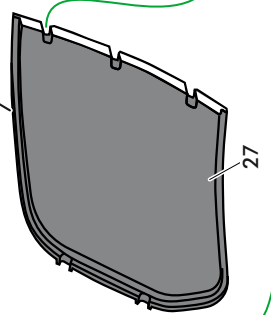
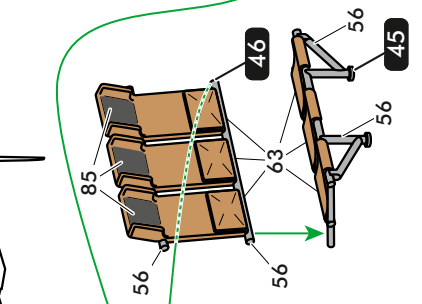
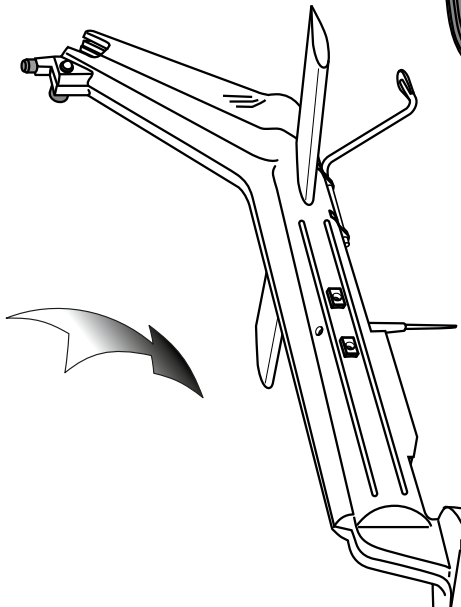
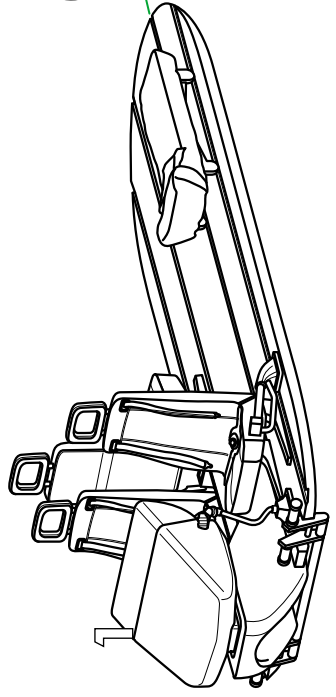
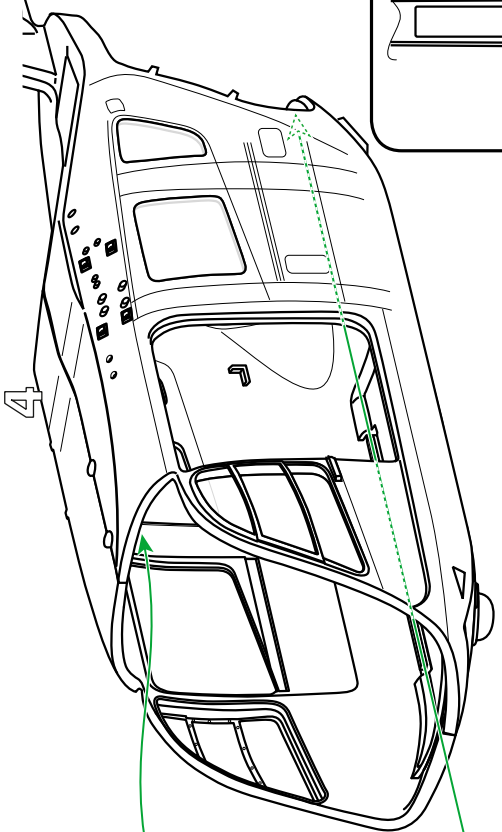
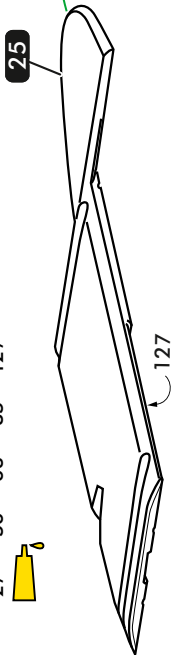

6

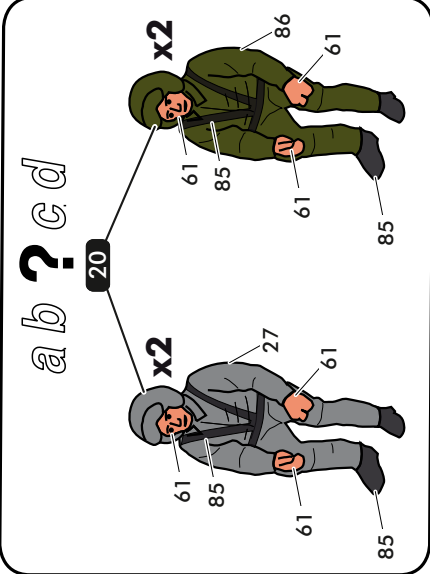
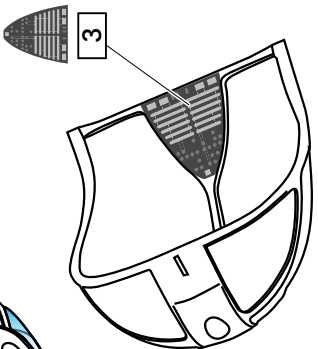
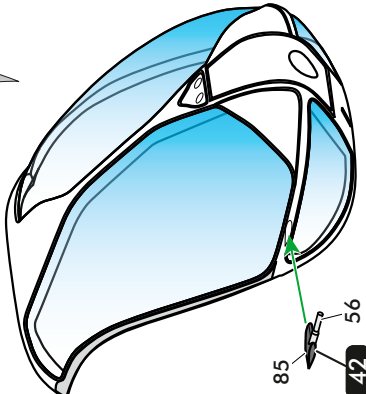
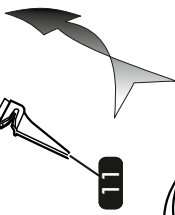
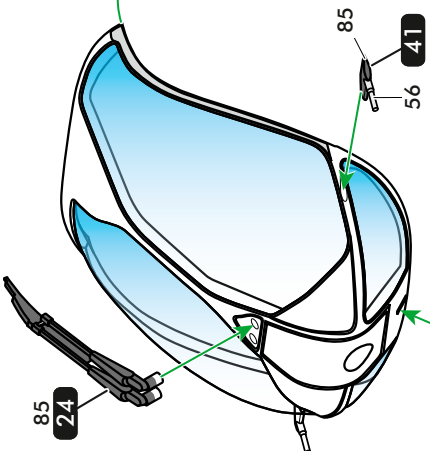
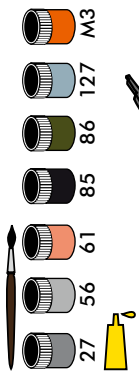

ab?cd

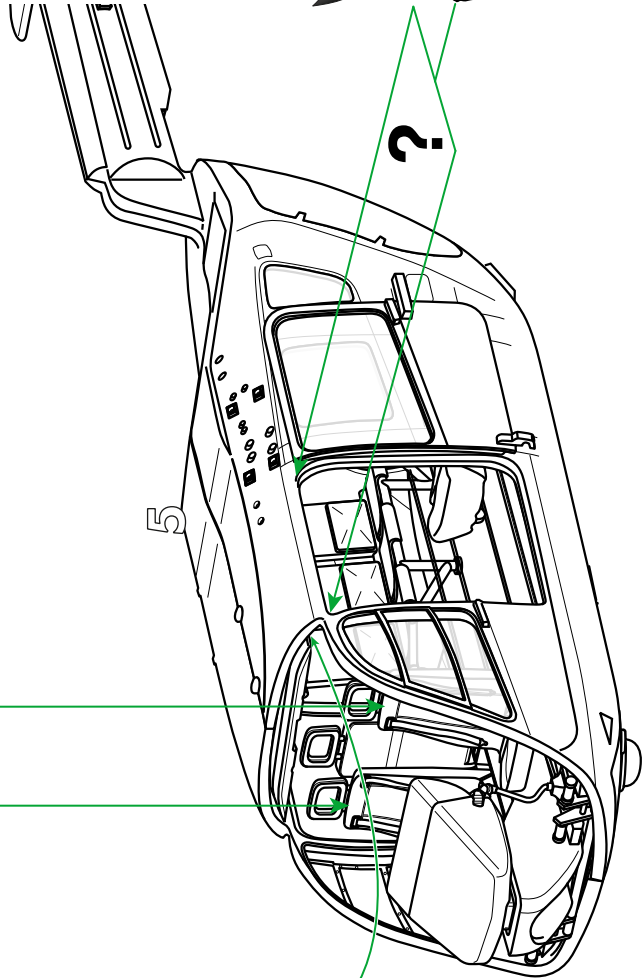
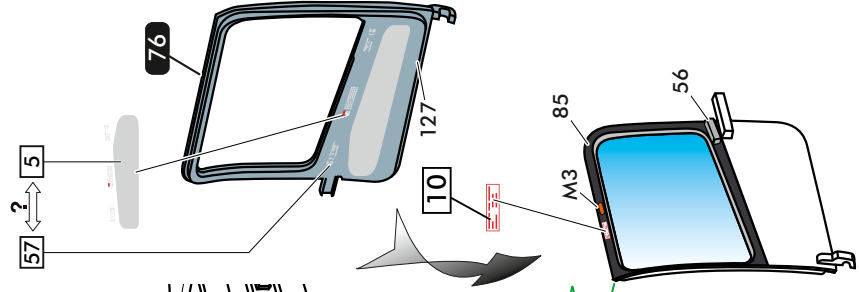

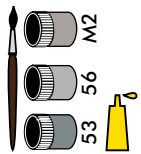

7

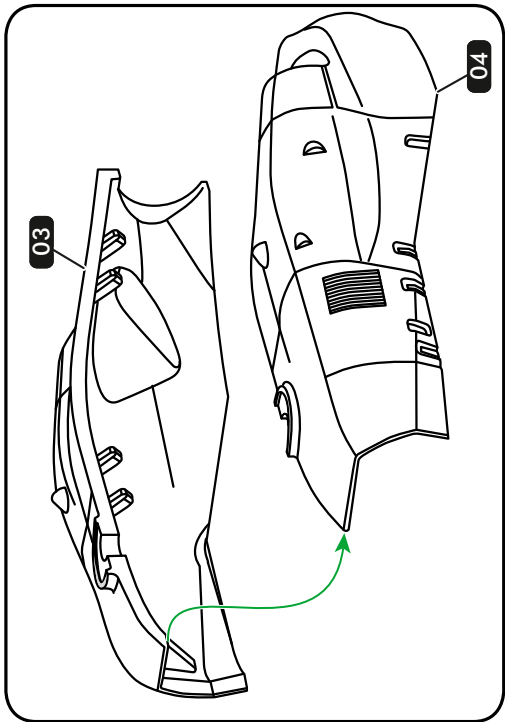
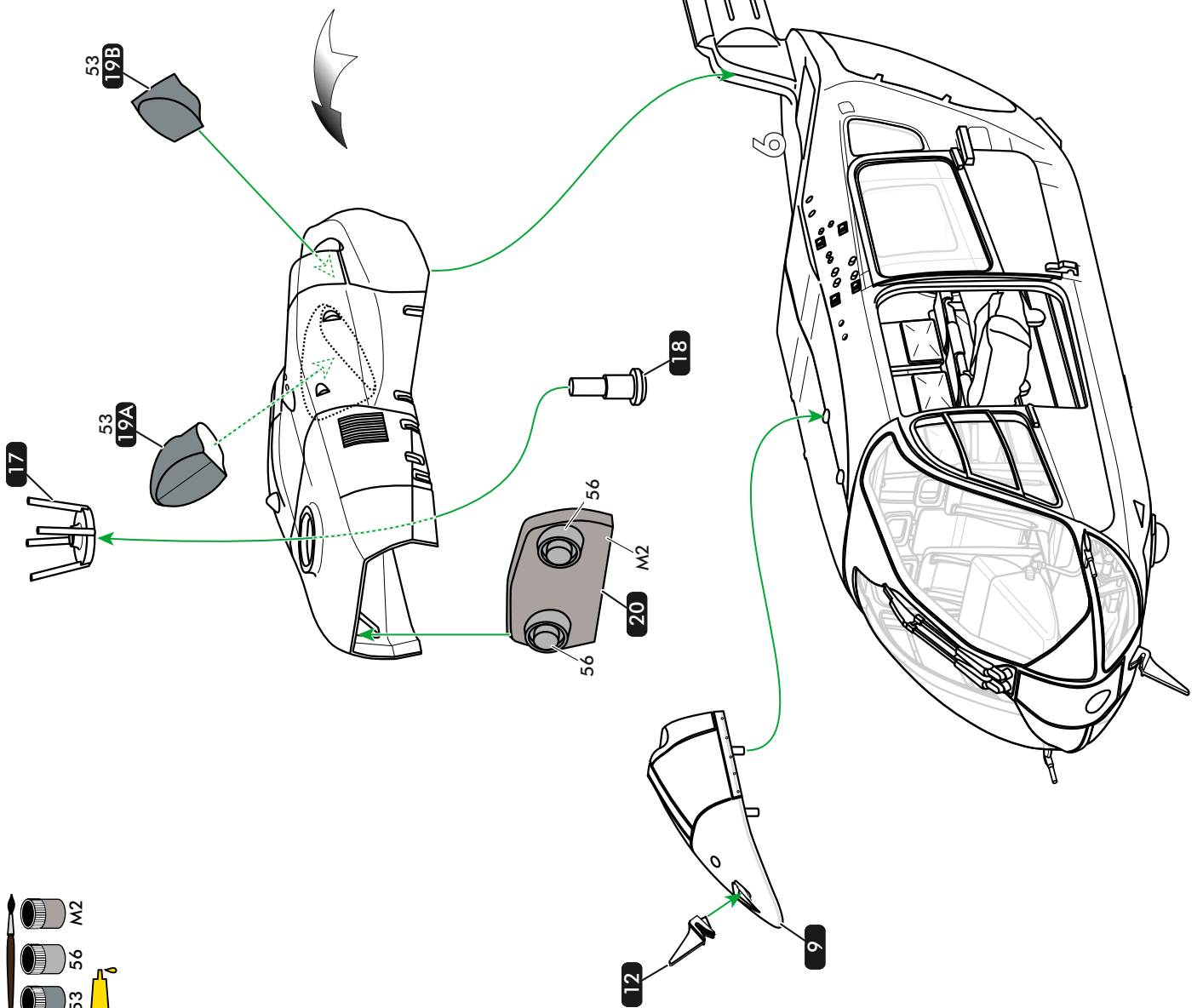



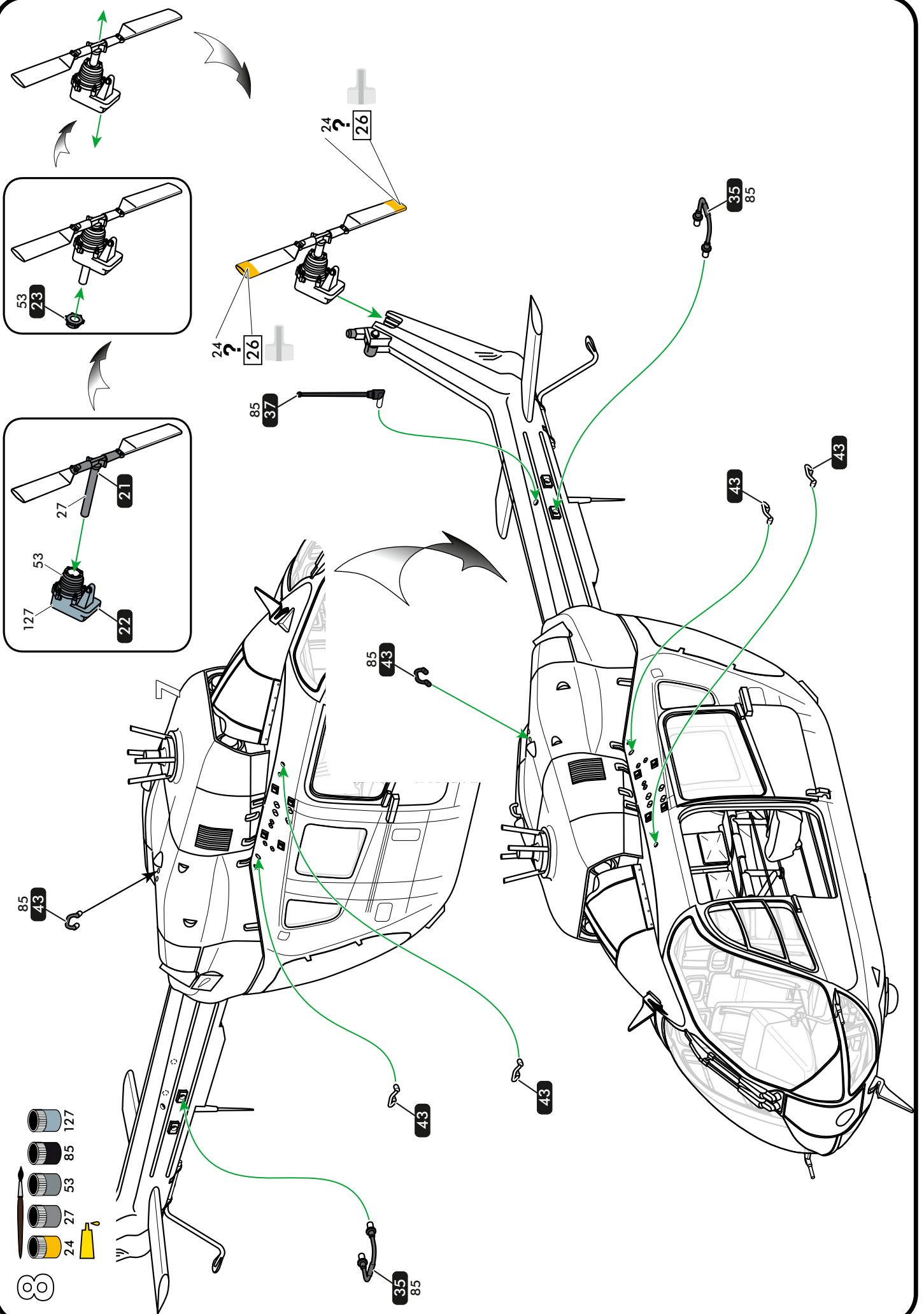
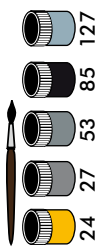

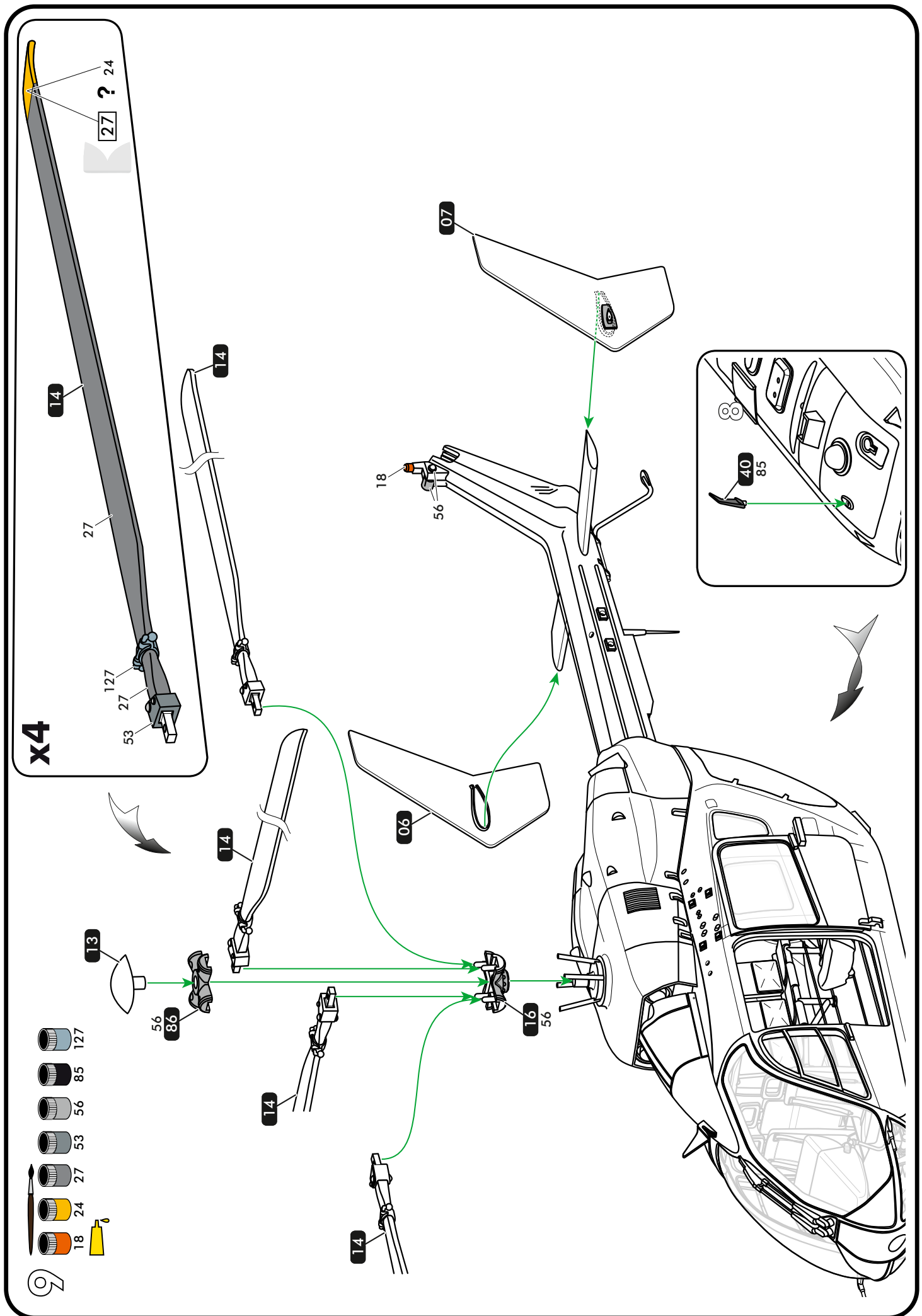

8





x4

27 ? **24**

-  127
-  85
-  56
-  53
-  27
-  24
-  18

13

56

86

14

14

14

06

07

18

56

16

56

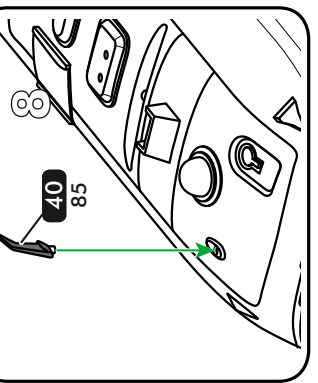

8

40

85

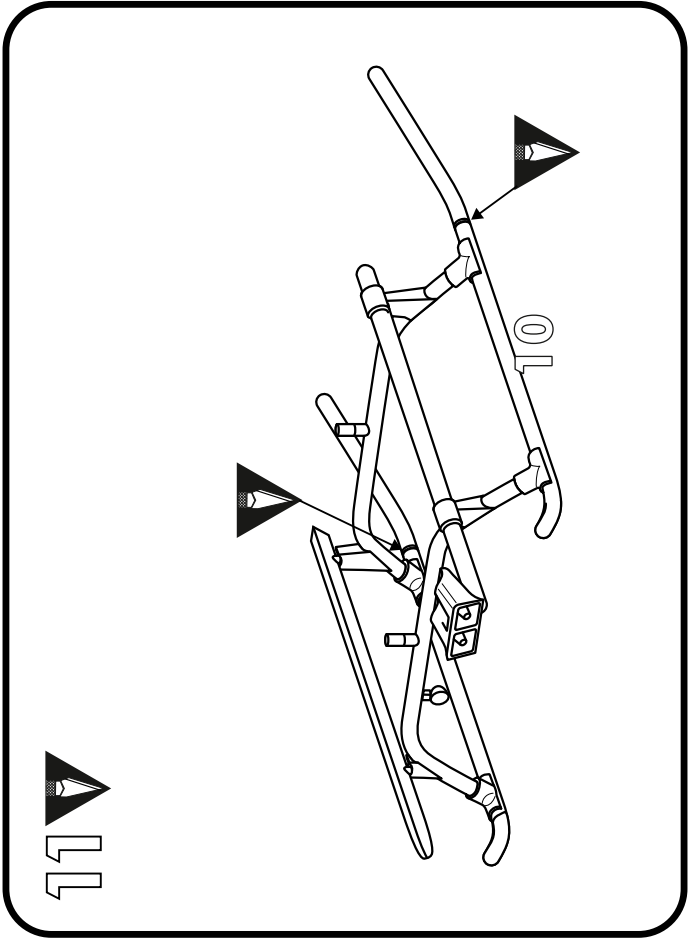
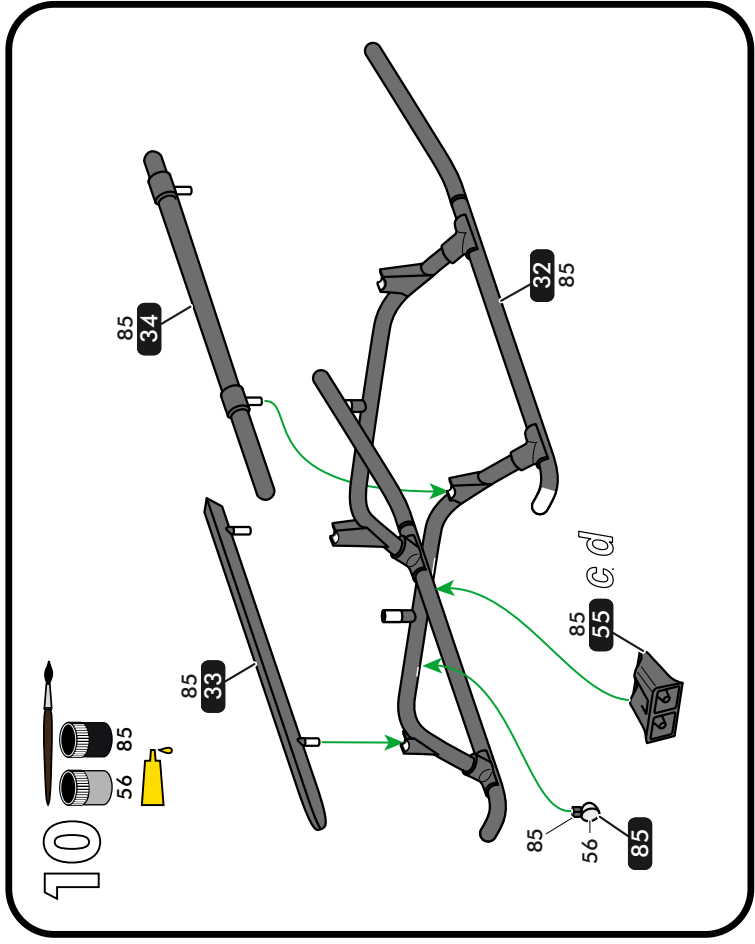
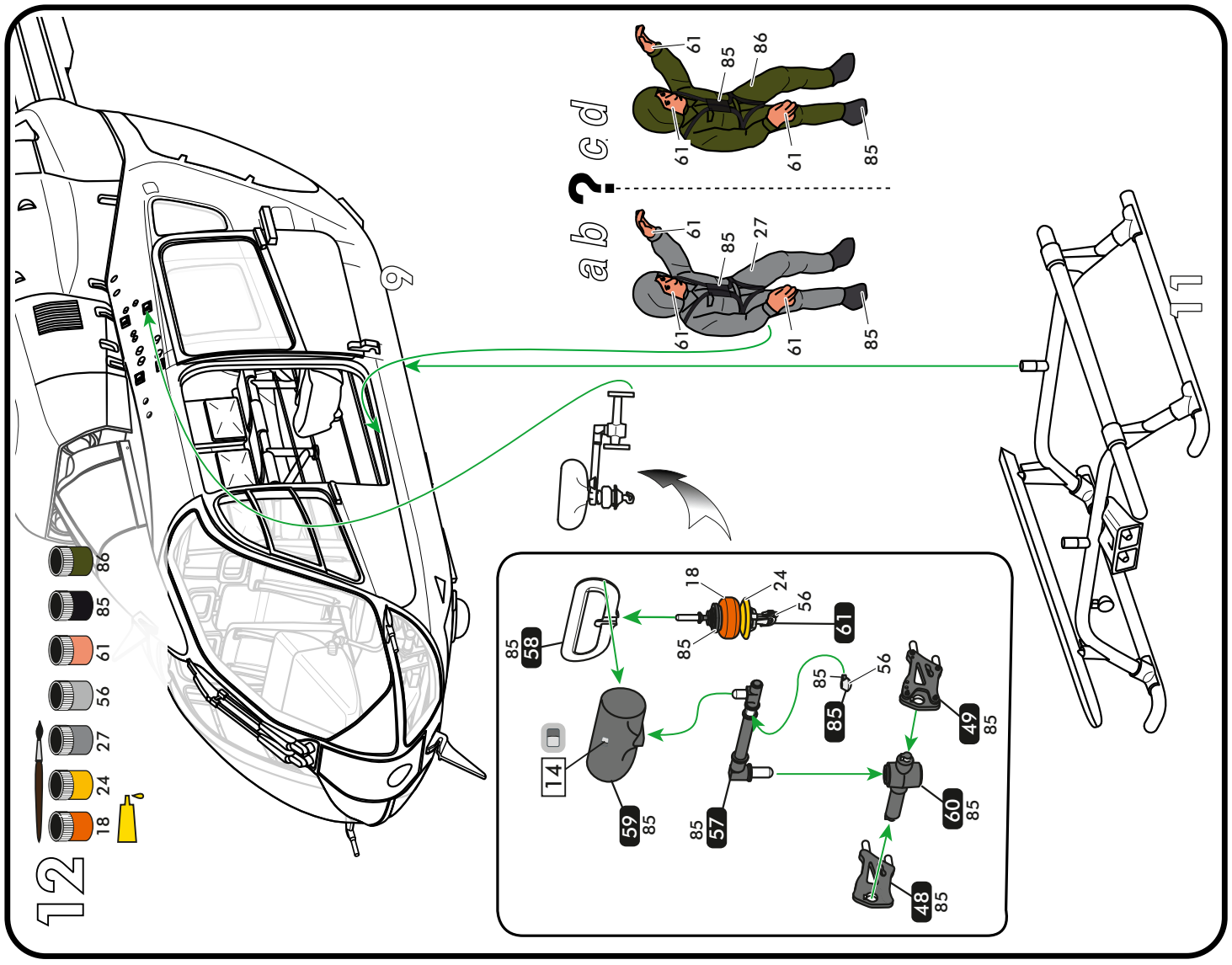

13

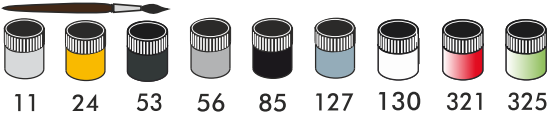

a US Naval Test Pilot School, Patuxent River, Maryland, 2020-2023
No.168245; 168246; 168247; 168248; 168249

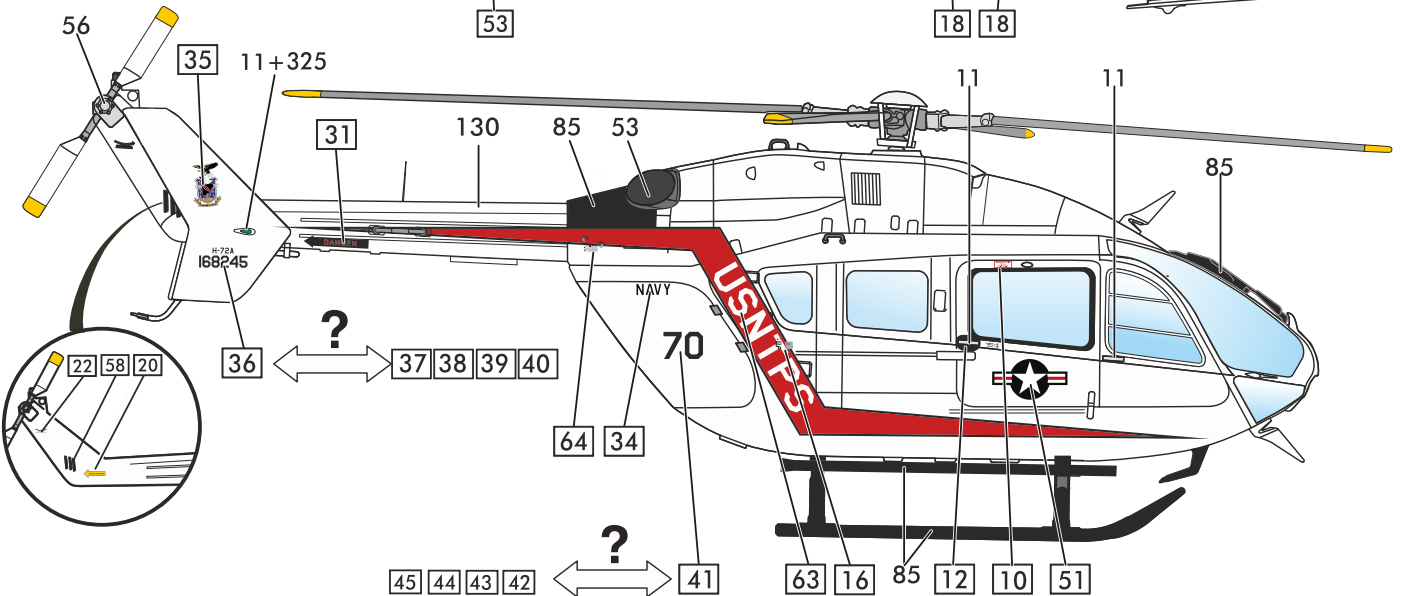
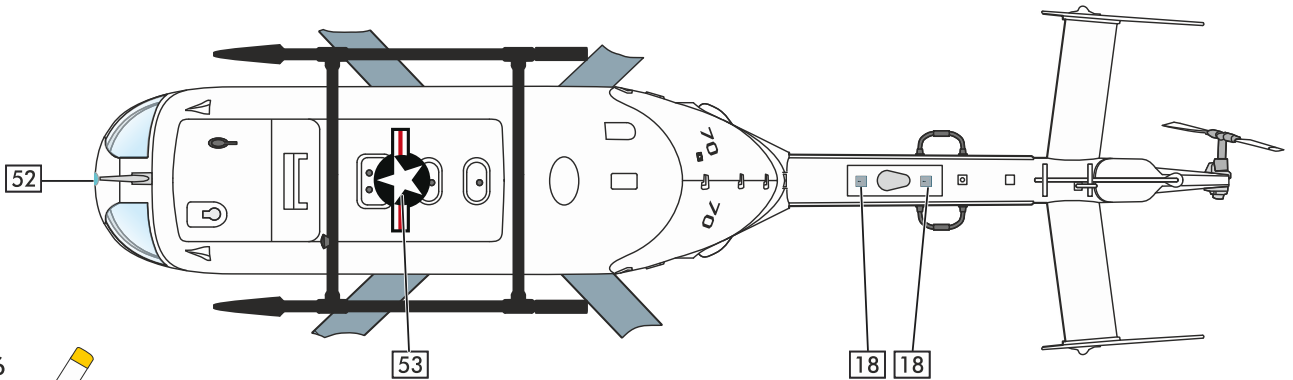
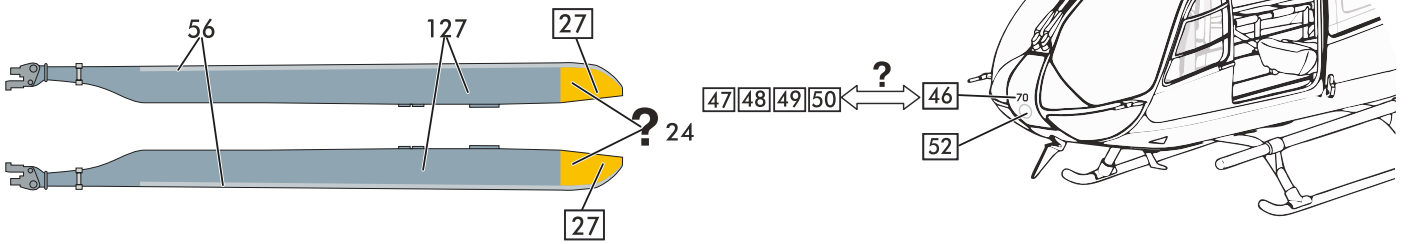
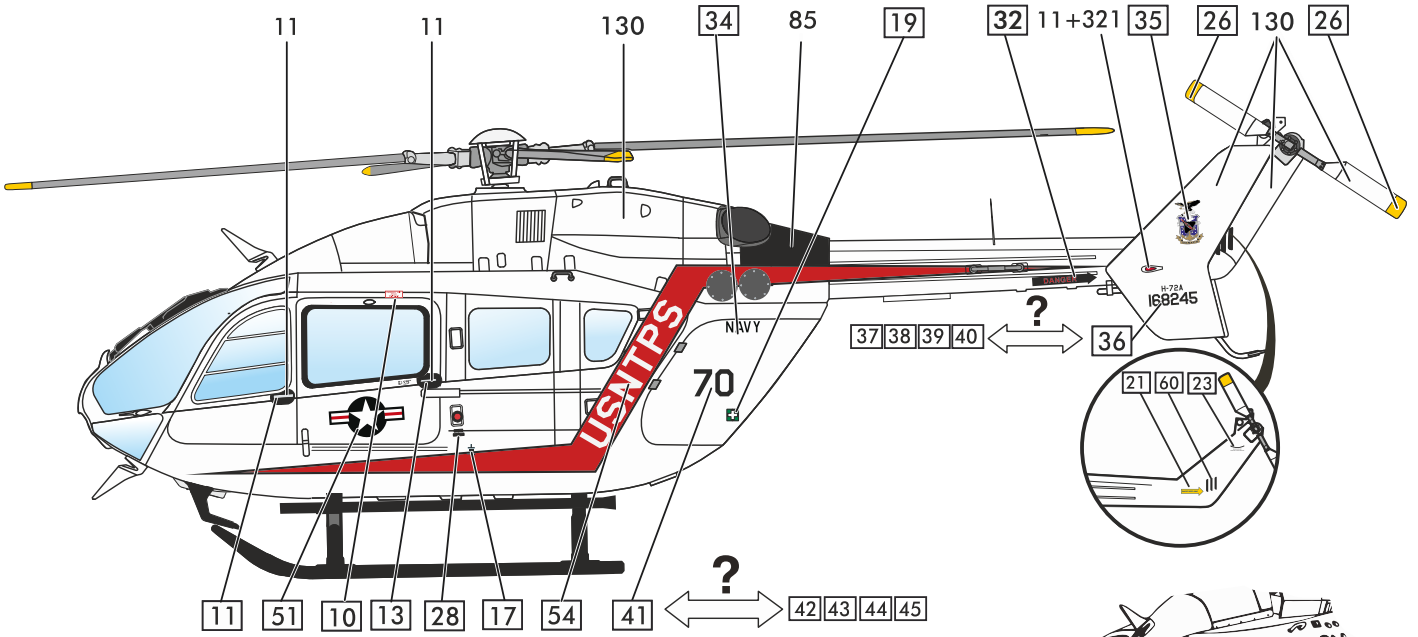

13

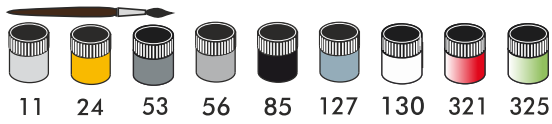

b US Naval Test Pilot School, Patuxent River, Maryland, N566AE, 2009

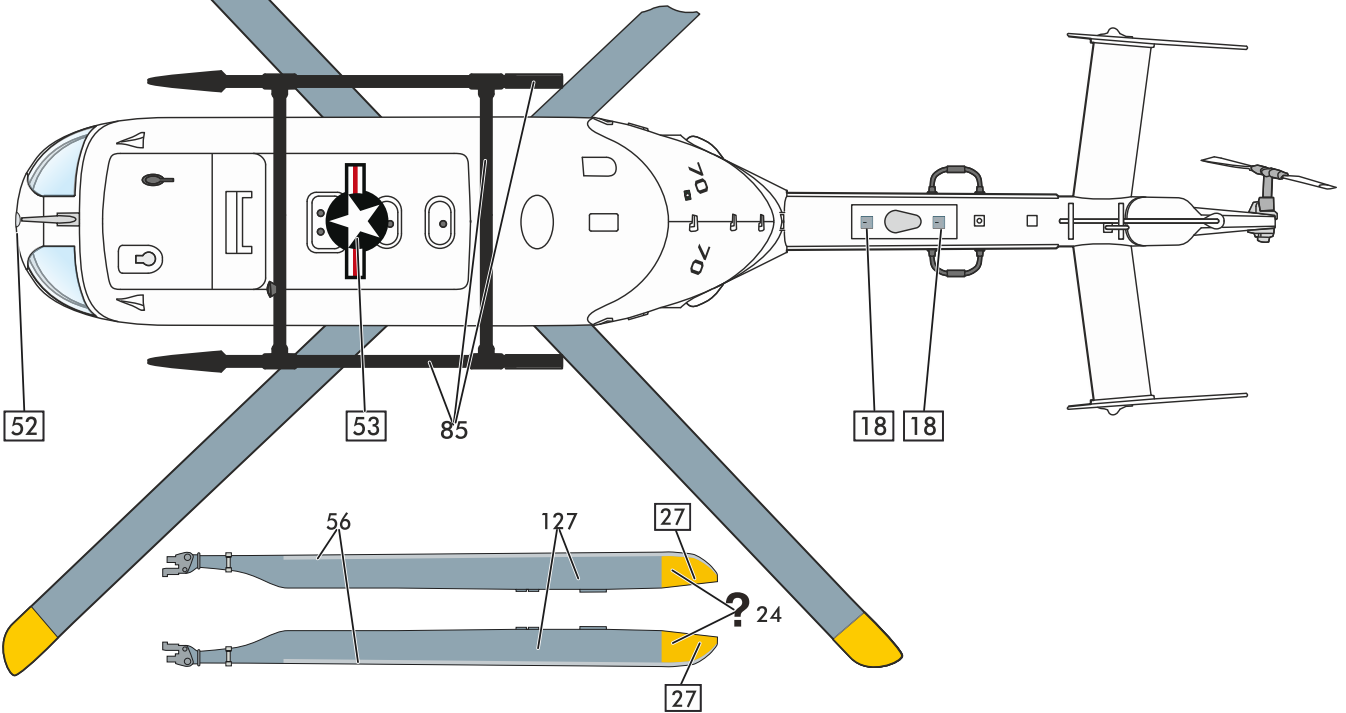
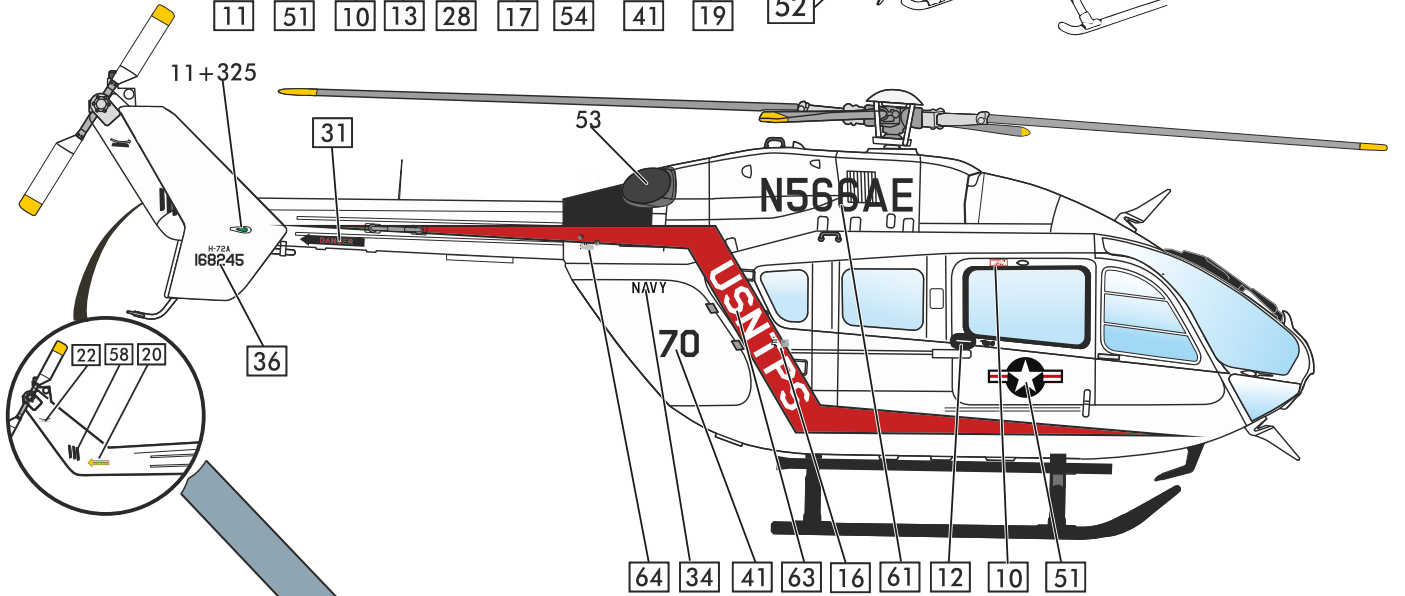
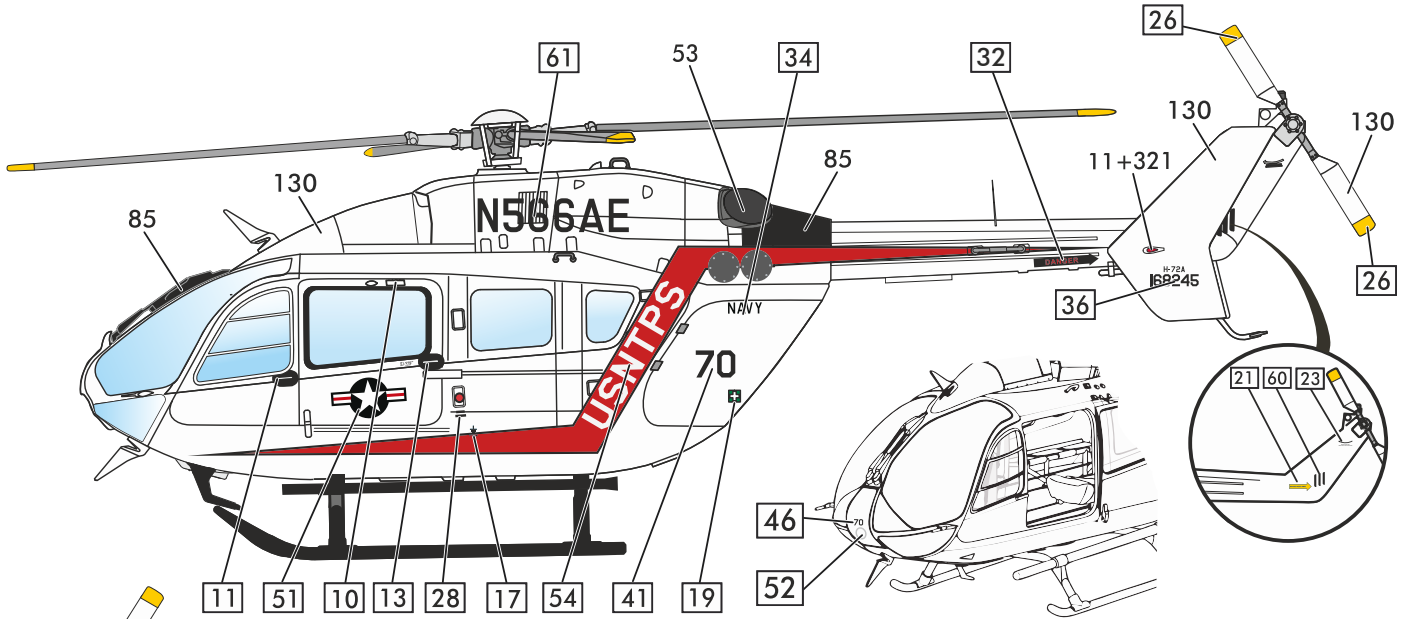

13

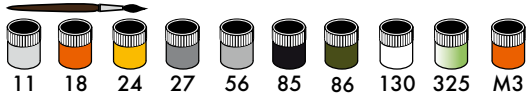

UH-72A "Lakota",
N145UH, Demonstration

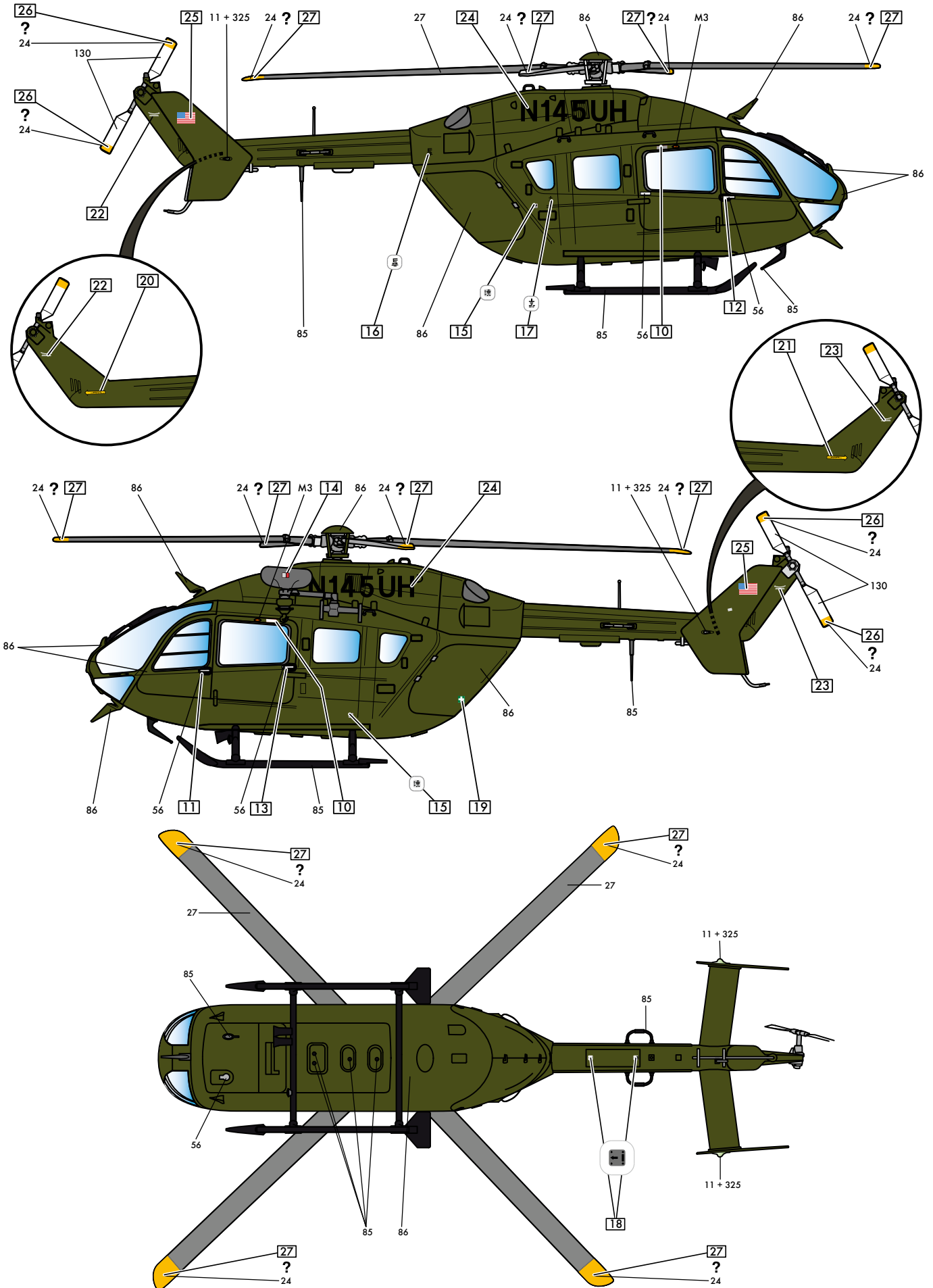

13

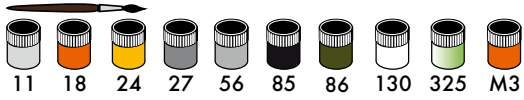

d UH-72A "Lakota",
72001, 2007

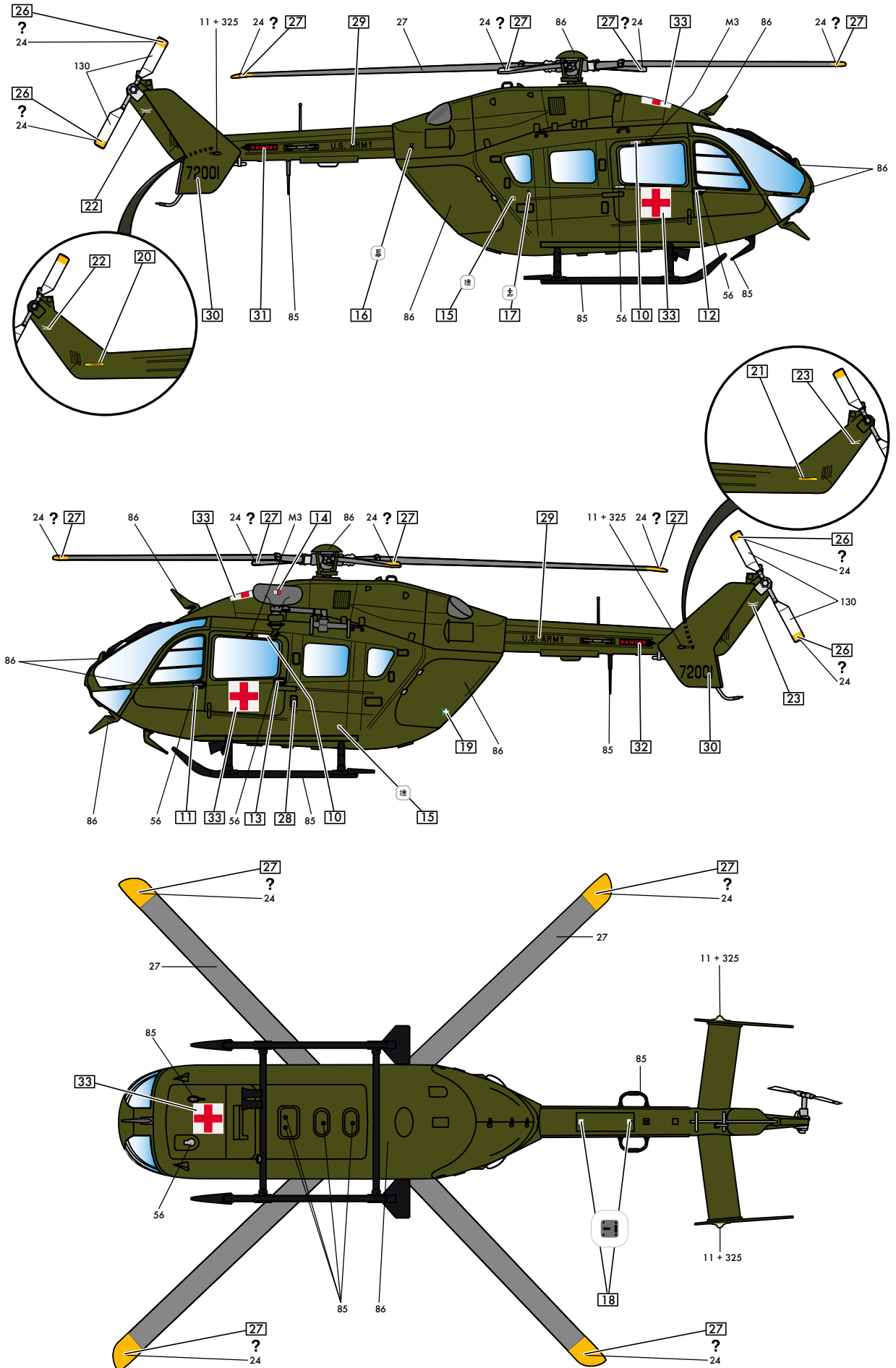

VISITEZ-NOUS EN LIGNE !

VISIT US DIGITALLY!
BESUCHEN SIE UNS DIGITAL!

 www.heller.fr

 [instagram.com/heller.fr](https://www.instagram.com/heller.fr)

 [facebook.com/heller.fr](https://www.facebook.com/heller.fr)

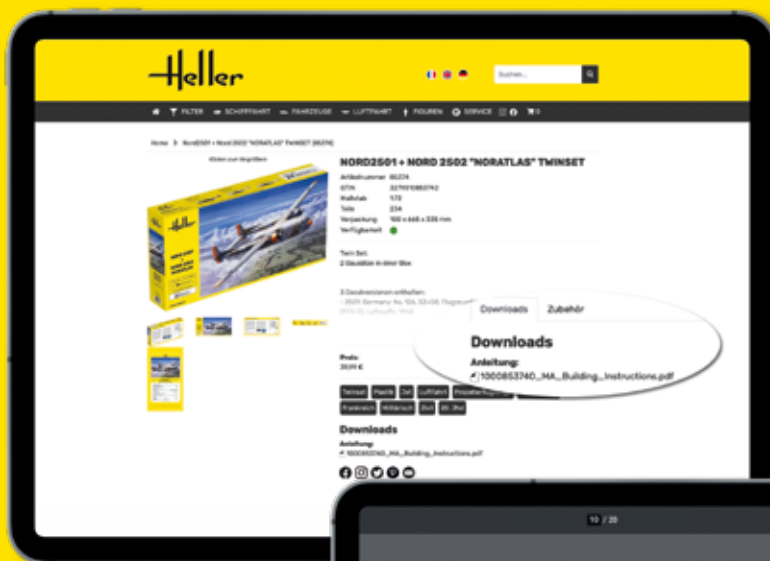

Choisissez l'article désiré et téléchargez la notice de montage.
Choose your desired article and download the instructions.
Wählen Sie den gewünschten Artikel und laden Sie die Anleitung herunter.

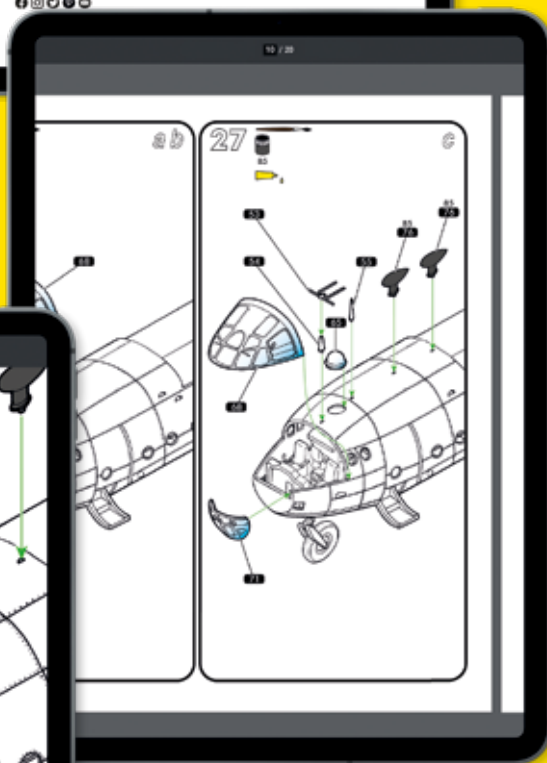

Download all instructions!

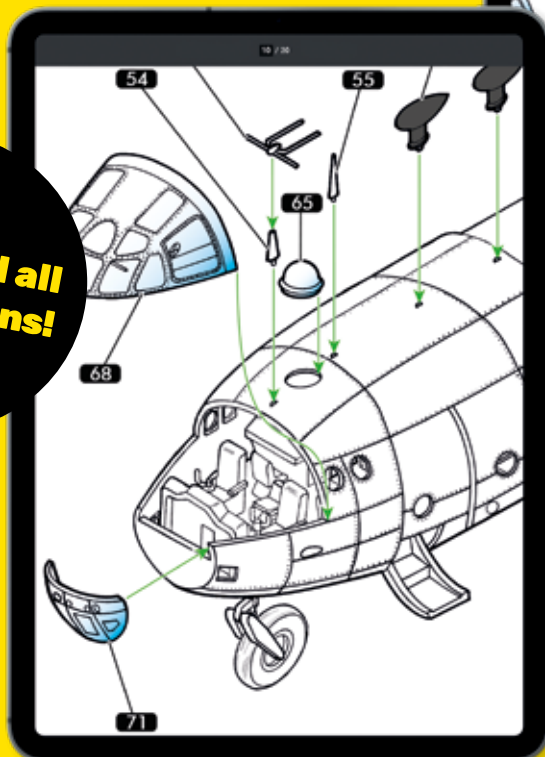

Grossissement des instructions pour une vue détaillée.



Enlarge the instructions for a more detailed view.

Vergrößern Sie die Anleitung für eine detailliertere Ansicht.

Service consommateurs
Pour toute demande de SAV, connectez-vous sur notre site www.heller.fr.

Customer Service
For after-sales service requests, please contact us through our website www.heller.fr.

Endverbraucherservice
Bitte besuchen Sie uns auf www.heller.fr für alle Ersatzteilanfragen.

Heller Hobby GmbH
Erlenbacher Str. 3 • 42477 Radevormwald • GERMANY
 +49 (0) 2195-92773-0  info@heller.fr